

sterling

SINKS & TAPS



SEPTEMBER 2024

Granite

Ceramic

Cast Iron

Stainless Steel

Sink & Tap Packs

Accessories

Kettle Taps

Filter Taps

Sensor Taps

Modern Taps

Traditional Taps

sterling

Shannon Place
Tewkesbury Business Park
Tewkesbury
GL20 8SL

Telephone: 01684 299555

Enquiries: orders@sterling.eu.com

To order: orders@sterling.eu.com

Website: www.sterling.eu.com



Scan for
Website



Scan for
Digital Copy

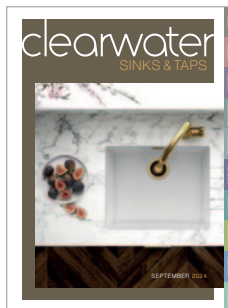

Please ask for your copy of our
Clearwater exclusive Sink and
Tap catalogue.



Retail Prices including VAT

Sterling is the Trading name of Clearwater Products Ltd
Registration No 03949040.

Colours are shown for your reference only.

Sterling reserves the right to change
product specifications without prior notice.

E&OE September 2024.

WELCOME TO STERLING

The essential ingredients that go into creating an inspirational kitchen are functionality, great design and faithful reliability. Our company ideal is to combine all three of these elements to provide the perfect sink and tap for you.

With Clearwater Products you can tailor and fine tune your exact requirements by selecting from the wide choice of sink and tap types, designs and materials.

We have divided our sinks between material and installation types and our taps between function and styles so you can quickly navigate our brochure to discover the perfect combination for your cooking, cleaning and design aspirations.

Our staff have extensive knowledge and experience of the kitchen industry and we are always on hand to answer any questions you may have - without you having to run the gauntlet of the automated switchboard!

All our products are sold exclusively through our network of dealers.

Phone us now for your nearest retail outlet.



8

Granite

28

Ceramic

92

Cast Iron

96

Stainless Steel

150

Sink & Tap Packs

152

Accessories

174

Kettle Taps

192

Filter Taps

214

Sensor Taps

218

Modern Taps

304

Traditional Taps



CERAMIC

Clearwater

Avola	46 - 47
Harmony	34 - 35
Jarla	40 - 41
Lydian Chef	30 - 31
Melody Pro	32 - 33
Metro Range	42 - 45
Opus	36 - 37
Sonnet	38 - 39

Thomas Denby British Classics

Belfast	49
Bredon	57
Buxton	61
Chiltern	55
Cotswold	59
Cumbria	58
Essex	52
Norfolk	51
Oxford	50
Tudor	53
Suffolk	56
Wessex	60
Windsor	54
Ashton 60	66
Heritage	65
Legacy	62
Utility & Laundry	66 - 67
Vintage 600 & 900	63
Vintage 800 & 800S	64

Villeroy & Boch

Architectura	76
Butler 60 & 90	83
Cisterna	75
Farmhouse 60, 80 & 90	82
Flavia	79
Medici	78
Provence	80 - 81
Siluet	68 - 69
Subway	70 - 74
Timeline	77
Accessories & Taps	84 - 85

Shaws

Bowland	90
Classic Belfast	86
Classic Butler	88

Shaws continued

Classic Bowl Range	87
Classic Double	86
Classic Shaker	89
Classic Waterside	88
Cleaners' Sink	91
Edgworth	91
Entwistle	91
Ribchester	90



GRANITE

Clearwater Quarex®

Capri	16 - 17
Gemini	12 - 13
Kameo Smart	10 - 11
Nova	14 - 15

Clearwater Quarsil®

Carina	20 - 21
Rio	24 - 25
Siena	26 - 27
Tivoli	22 - 23



CAST IRON

Clearwater

Saxon 560	94
Saxon 200	95



SINK + TAP PACKS

Granite	150
Stainless Steel	151



STAINLESS STEEL INSET

Clearwater

Arco	121
Arco Mini	121
Ava	100
Bar 47	120
Basics	122 -123
Bella	120
Bolero	101
Cresta	110
Deep Blue	104
Indio	102 -103
Kudos	105
Monza	109
Oboe	121
Okio	106 -107
Pio Bar	120
Solar	111
Starline	99
Urban	116 -117
Urban Smart	118 -119
Verdi	98
Viva	108
Xeron	112 -113
Zenith	114 -115

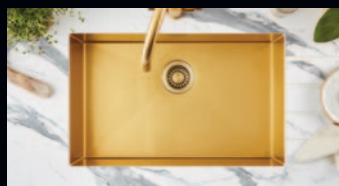

STAINLESS STEEL UNDERMOUNT

Clearwater

Jazz	126 -127
Salsa	128 -129
Salsa PVD	144 -145
Stark	134 -135
Stark Smart	136 -137
Stereo	132 -133
Tango	130 -131
Volta	138 -139
Volta PVD	140 -141
Volta PVD Nano	142 -143
Vortex	124 -125



APRON FRONT

Clearwater

Infinity Smart	148 -149
Belfast	146 -147



ACCESSORIES

Cleaning Products	321
Colanders, Trays, Boards	162
Filter Cartridges	160
Furniture Handles	164 -165
Plate Racks & Drainers	161
Waste Disposers	152 -153
Wastes & Plumbing Kits	158 -160
Waste Sorter Bins	163
Wine Cabinets	154 -157



LIGHTING

Sensio Series 1	166 -167
Under & In Cabinet	168 -169
Plinth	170 -171
Controls	172
Profiles	173



CLEARWATER

Twist & Spray

Davina	226
Rococo	224
Savita	220
Siren	220
Topaz	222 - 223
Tutti	225
Zodiac	221

Standard

Auriga	240
Alzira	227
Auva	234
Corona	238
Cherika	239
Creta	241
Dorman	241
Elara	236
Jovian	235
Juno	228
Levant	230
Loreto	234
Miram	237
Morpho	232 - 233
Pioneer	229
Pulsar	238
Rossi	240
Sheratan	239
Studio	241
Taku	231
Ultra	241
Vegas	238
Venue (Contract)	264
Vitro	240

Pull-Out

Auriga	251
Creta	249
Elmira	250
Emporia	250
Karuma	246
Kira	245
Larissa	243
Levant	242
Pioneer	248
Porrima	249
Santor	247
Topaz	244

Professional

Alasia	252 - 253
Galaxy	254
Jovian	257
Meridian	256
Triton	255
Tutti Pro	255

Stainless Steel

Calypso	261
Galaxy	260
Mercury	260
Sirius	259
Titania	258
Mira (Cold Water Siphon)	260



CLEARWATER

Pull-Out Spray

Modern	262
Traditional	263



CLEARWATER SENSOR TAPS

Amelio	216
Azia	217
Esto Basin Tap	320
Galex Motion	214 - 215



CLEARWATER

Traditional

Alrisha	311
Baroc	308
Baroc Bridge	308
Coriolis	311
Cottage	309
Cottage Bridge	309
Dephini	310
Dephini Bridge	310
Regent	311

Twist & Spray Traditional

Elegance	307
Elegance Bridge	307



ARAYA

Mercia (Contract)	265
-------------------	-----



KWC

Domo 6	272 - 273
Eve Mini	267
Eve	266 - 267
Inox	277
Kio	268 - 269
Livello	275
Luna-E	270 - 271
Ono Highflex	274
Sin	276
Zoe	278 - 279

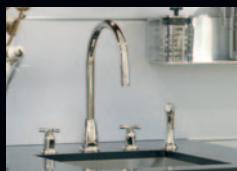

PERRIN & ROWE

Modern

Callisto	280 - 281
Mimas	283
Oberon	282
Orbiq	283
Rubiq	281

Traditional

Alsace	314
Armstrong	318 - 319
Etruscan	316
Ionian	313
Mayan	317
Minoan	316
Parthian	316
Phoenician	312
Picardie	315
Provence	314 - 315



GROHE

Ambi	299
Essence	296 - 297
Eurocube	300
Eurosmart	298
K7	302 - 303
Minta	301
Zedra	300



ABODE

Modern

Althia	288
Astral	284
Atik	285
Atlas Quad	286
Atlas	286
Coniq	290
Czar	289
Flair	284
Fluid	287
Fraction	291
Gosford	287
Hex	292 - 293
New Media	285
Nexa	284
Pico	287
Quantic	285

Stainless Steel

Airo	295
Axial Pot Filler	294
Propus	294
Quala	295
Stalto	295
Taura	294

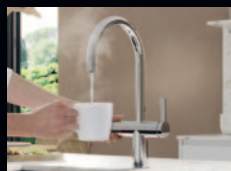

KETTLE TAPS

Clearwater

Hotshot 1 & 2	180 - 181
Magus 3	176 - 177
Magus 4	178 - 179
Longdon 4	182 - 183

ISE

Insinkerator	184 - 187
--------------	-----------

Perrin & Rowe

Armstrong Hot	190
Mini Instant Hot	189
Phoenix	188
Polaris Traditional	189



FILTER TAPS

Clearwater

Alpha	206
Aquarius (S/S)	208
Bellatrix	200 - 201
Eclipse Tri-Spa	205
Galex	198 - 199
Hydra	207
Krypton Tri-Spa	204
Malin	207
Mariner	194 - 195
Mira filter only (S/S)	208
Neso	206
Rosetta	196
Stella Tri-Spa	202 - 203
Toledo	197
Zuben (S/S)	209
Pure Chiller 100	209

Perrin & Rowe

Armstrong Filter	191
Etruscan	213
Metis	211
Mimas	212
Parthian	211
Phoenician	210
Picardie	212

QUAREX®

QUAREX®

The latest generation of Quarex® has been achieved over many years of development and this latest compound which includes 80% quartz has been enriched with silver ions.

Silver nano-particles form a protective coating on the surface of the granite with the anti-microbial properties reducing the growth of bacteria and microbes by as much as 98%.

HYGIENIC SURFACE

The advanced anti-bac surface ensures optimum safety when handling food and the fine structure of Quarex® offers dirt-repellent properties.

RESILIENT SURFACE

The robust qualities of Quarex® ensure high resistance to the rigours of the kitchen environment including a high ability to withstand scratches, impacts and high temperatures.



Dirt-repellent effect



Odour-free



Heat-resistant 180°C



Food-safe



Hygienic Surface



Made to last



Stain-resistant



Impact-resistant



Clearwater
Granite Care Set
Ref. CLEG100 £40

Comprising of -
an alcohol based cleaner
a brightener and a
nano sponge

QUAREX® COLOURS

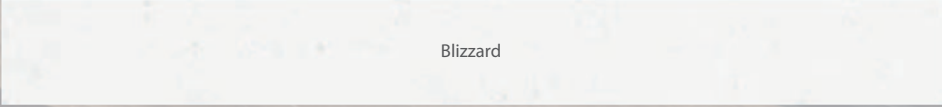

Blizzard

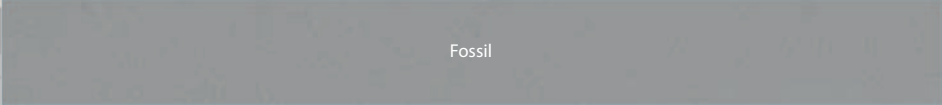

Fossil

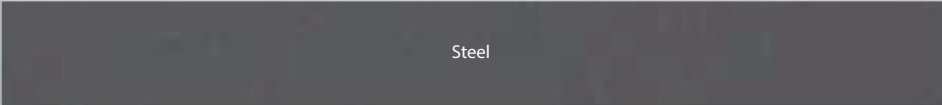

Steel



Slate

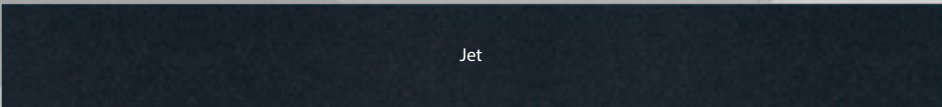

Jet

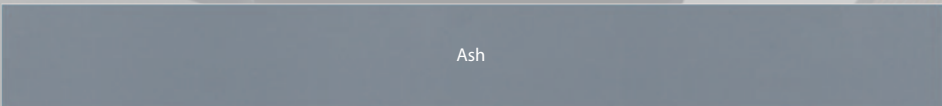

Ash

ICONS EXPLAINED

Installation



Inset



Undermount

Handing



Reversible

Other Details



Waste Included



CLEARWATER
GRANITE SINKS
HAVE A LIFETIME
WARRANTY

Matching Wastes Available

Coloured wastes available to match your choice of tap - see following pages.



Artisan Brass



Regency Copper



Gold



Matt Black



Kameo D150L in Blizzard shown with Morpho Brushed Brass tap with flex and stay spout - see page 232-233

Accessory Included



Ref. WBD433
Wooden Chopping Board

Optional Accessories



Ref. COL415
Stainless Steel Colander £120
Fits main bowl only



Ref. TR415
Stainless Steel Tray £46
Fits main bowl only

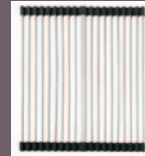

Ref. DR3000
Stainless Steel
Draining Mat
(square bar) £59



Kameo D150L in Blizzard shown with Stainless Steel Draining Mat

BLIZZARD (BL) ASH (AH) FOSSIL (FL) STEEL (ST) SLATE (SL) JET (JT)



Add colour suffix when ordering
See page 9 for larger colour samples and to learn about the amazing properties of Quarex®.

Standard Waste Kits



Brushed Steel
supplied as standard

Optional Coloured Wastes



Artisan Brass
W900AB £69
W90AB £53



Artisan Brass
W60AB £43



Regency Copper
W900RC £69
W90RC £53



Regency Copper
W60RC £43



Matt Black
W900MB £69
W90MB £53



Matt Black
W60MB £37

1.0 Bowl = 1 x W900**

1.5 Bowl = 1 x W90** + 1 x W60**



Kameo D100L in Slate shown with Pioneer pull-out tap in Brushed Nickel - see page 248



Kameo Smart Single bowl and drainer
Ref. **KAM D100L** £299

Overall size: 1000/500 mm
Bowl size: 480/440/200 mm
Cutout size: 980/480 mm
Minimum cabinet size: 600 mm
Standard waste kit included

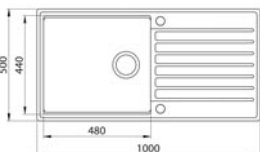

Kameo Smart 1.5 bowl and drainer
Ref. **KAM D150L** £329

Overall size: 1000/500 mm
Bowl size: 400/440/200 mm
Half bowl: 120/320/120 mm
Cutout size: 980/480 mm
Minimum cabinet size: 600 mm
Standard waste kit included

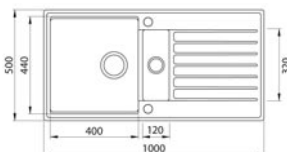

KAMEO SMART QUAREX®



The **Kameo** sinks feature a 'Smart Ledge' that is designed into each bowl enabling a set of four catering accessories to be employed for chopping, straining and draining. These sinks combine fresh contemporary styling with huge capacity bowls that will swallow up a multitude of jobs.

The D150 principal bowl is noteworthy for its unrivalled generous width of 400mm. This has been achieved by minimizing the strainer bowl with the use of a compact 60mm strainer waste and the extra space gained has been allocated to the main bowl where it is needed most.



Gemini D100S in Blizzard

Standard Wastes



Chrome
Included with sink

Optional Presto Automatic Waste Kits

For full details about the Presto Automatic Waste see page 159



Stainless Steel
WP10SS £44
WP20SS £48



Artisan Brass
WP10AB £114
WP20AB £116



Regency Copper
WP10RC £114
WP20RC £114



Matt Black
WP10MB £75
WP20MB £79

Gemini GEM D100S = WP10**
Gemini GEM D150S = WP20**



Gemini Single bowl and drainer

Ref. GEM D100S £289

Overall size: 780/500 mm
Bowl size: 450/410/200 mm
Cutout size: 760/480 mm
Minimum cabinet size: 600 mm
Standard waste kit included

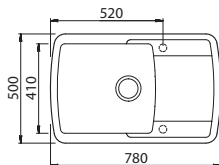

Gemini 1.5 bowl and drainer

Ref. GEM D150S £349

Overall size: 960/500 mm
Bowl size: 360/437/200 mm
Half bowl: 160/345/120 mm
Cutout size: 940/480 mm
Minimum cabinet size: 600 mm
Standard waste kit included

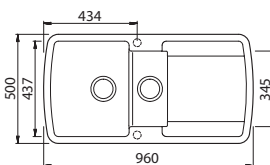

BLIZZARD (BL) FOSSIL (FL) JET (JT)

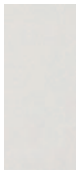

Add colour suffix when ordering

See page 9 for larger colour samples and to learn about the amazing properties of Quarex®.



Gemini D150S in Jet shown with Magus 3 kettle tap in Chrome - see pages 176 -177

GEMINI QUAREX®



The **Gemini** steps away from the fashion for minimalist symmetry and instead embraces a soft curved design. The bowl sizes are larger than most sinks and the drainer is particularly smart.

The Gemini would be an ideal choice with Shaker style kitchens. Available in three Quarex® colours.



Magus 3 kettle tap in Chrome - see pages 176 -177



Icons Explained
see page 9.



Nova N330 in Jet shown with Amelio Sensor tap in Matt Black - see page 216



Nova Single bowl
Ref. NOV N330 £279
 Overall size: 380/380 mm
 Bowl size: 330/330/190 mm
 Cutout size: Template Available
 Minimum cabinet size: 450 mm
 Standard waste kit included

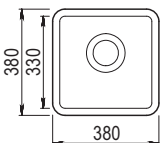

Nova Single bowl
Ref. NOV N370 £299
 Overall size: 420/460 mm
 Bowl size: 370/410/200 mm
 Cutout size: Template Available
 Minimum cabinet size: 450 mm
 Standard waste kit included

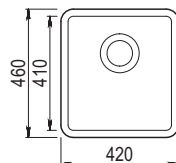

Nova Single bowl
Ref. NOV N535 £339
 Overall size: 585/460 mm
 Bowl size: 535/410/210 mm
 Cutout size: Template Available
 Minimum cabinet size: 800 mm
 Standard waste kit included

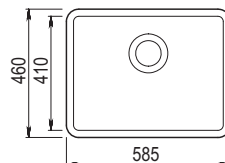

Nova Single bowl
Ref. NOV N780 £439
 Overall size: 810/480 mm
 Bowl size: 760/430/230 mm
 Cutout size: Template Available
 Minimum cabinet size: 1000 mm
 Standard waste kit included

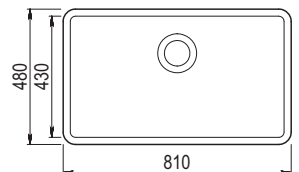

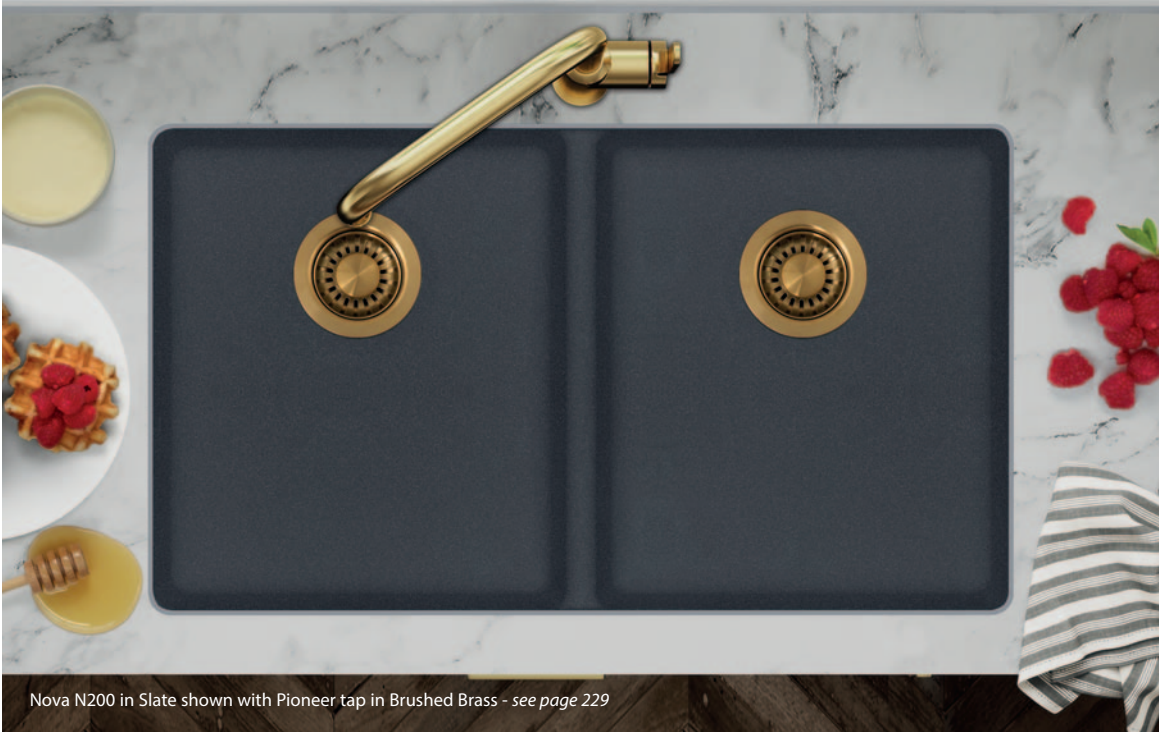

Nova N200 in Slate shown with Pioneer tap in Brushed Brass - see page 229

NOVA QUAREX®



The **Nova** collection of sinks offer a selection of bowl sizes that will suit all kitchen demands, from the Compact N330 secondary/entertainment sink to the huge N780 with capacious dimensions that will swallow up the largest of oven trays and pans. The soft radius corners of the Nova make it an ideal choice for both modern and retro kitchen designs. They can be installed as undermount or inset.



Add colour suffix when ordering

See page 9 for larger colour samples and to learn about the amazing properties of Quarex®.



Nova 1.5 bowl

Ref. NOV N150 £359

Right hand main bowl only
 Bowl size: 349/441/195 mm
 Half bowl: 163/361/160 mm
 Cutout size: Template Available
 Minimum cabinet size: 600 mm
 Standard waste kit included

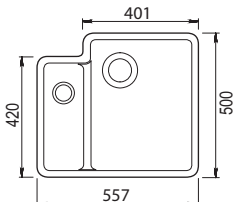

Nova Double bowl

Ref. NOV N200 £479

Overall size: 810/480 mm
 Bowl sizes: 370/430/230 mm
 Cutout size: Template Available
 Minimum cabinet size: 1000 mm
 Standard waste kit included

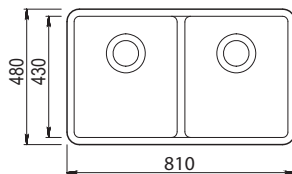

Standard Wastes



Stainless
 Included
 with sink

Optional Coloured Wastes

1.0 Bowl = 1 x W900**
 2.0 Bowl = 1 x W90** + 1 x W90**
 1.5 Bowl = 1 x W90** + 1 x W60**
 60mm waste is not available in Gold



Gold
 W900G £69
 W90G £53



Regency Copper
 W900RC £69
 W90RC £53
 W60RC £43



Artisan Brass
 W900AB £69
 W90AB £53
 W60AB £43



Matt Black
 W900MB £69
 W90MB £53
 W60MB £37



Capri N505 in Steel



Capri N690 in Blizzard

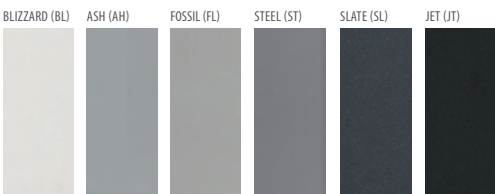

Add colour suffix when ordering
See page 9 for larger colour samples and to learn about the amazing properties of Quarex®.

CAPRI QUAREX®



The **Capri** collection comprise three futuristic styled bowls featuring a unique sloping rear ledge housing the overflow outlet. This unusual arrangement looks very sophisticated when combined with narrow radius bowls which emphasize the Capri's crisp lines. The Capri's Ledge Overflow maximizes the depth of water in the bowl before the overflow is employed. The Capri can be installed as an Undermount or Inset.



Stainless Steel Square wastes are supplied with the Capri in keeping with the Capri's ultramodern aesthetics.



Capri N175 in Slate shown with Zuben Stainless Steel Filter tap - see page 209



Capri Single bowl
Ref. CAP N505 £339

Overall size: 555/455 mm
Bowl size: 505/405/200 mm
Cutout size: Template Available
Minimum cabinet size: 600 mm
Waste kit included

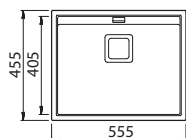

Capri Single bowl
Ref. CAP N690 £399

Overall size: 740/455 mm
Bowl size: 690/405/200 mm
Cutout size: Template Available
Minimum cabinet size: 800 mm
Waste kit included

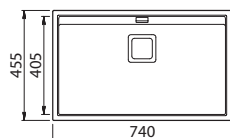

Capri 1.75 bowl
Ref. CAP N175 £449

Overall size: 650/455 mm
Bowl size: 375/405/200 mm
Half bowl: 220/405/180 mm
Cutout size: Template Available
Minimum cabinet size: 800 mm
Waste kit included

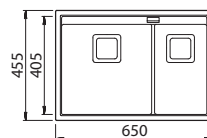

Icons Explained
see page 9.

QUARSIL®

QUARSIL®

The new generation of Quarsil® has been developed over 30 years and now features substantially improved properties. It is now even easier to clean and has a new intensity of colour.

HYGIENIC SURFACE

The advanced anti-bac surface quality of Quarsil® ensures optimum safety when handling food.

DIRT-REPELLENT EFFECT

The material's fine structure means dirt that could be a breeding ground for bacteria finds it impossible to stick to the surface.

PRODUCT BENEFITS

QUARSIL® Granite sinks are up to 80% natural quartz sand and specially developed for the demands of the kitchen, and the rigours of everyday use.



Dirt-repellent effect



Odour-free



Heat-resistant 180°C



Food-safe



Hygienic Surface



Made to last



Stain-resistant



Impact-resistant



**Clearwater
Granite Care Set**
Ref. CLEG100 £40

Comprising of -
an alcohol based cleaner
a brightener and a
nano sponge

QUARSIL® COLOURS

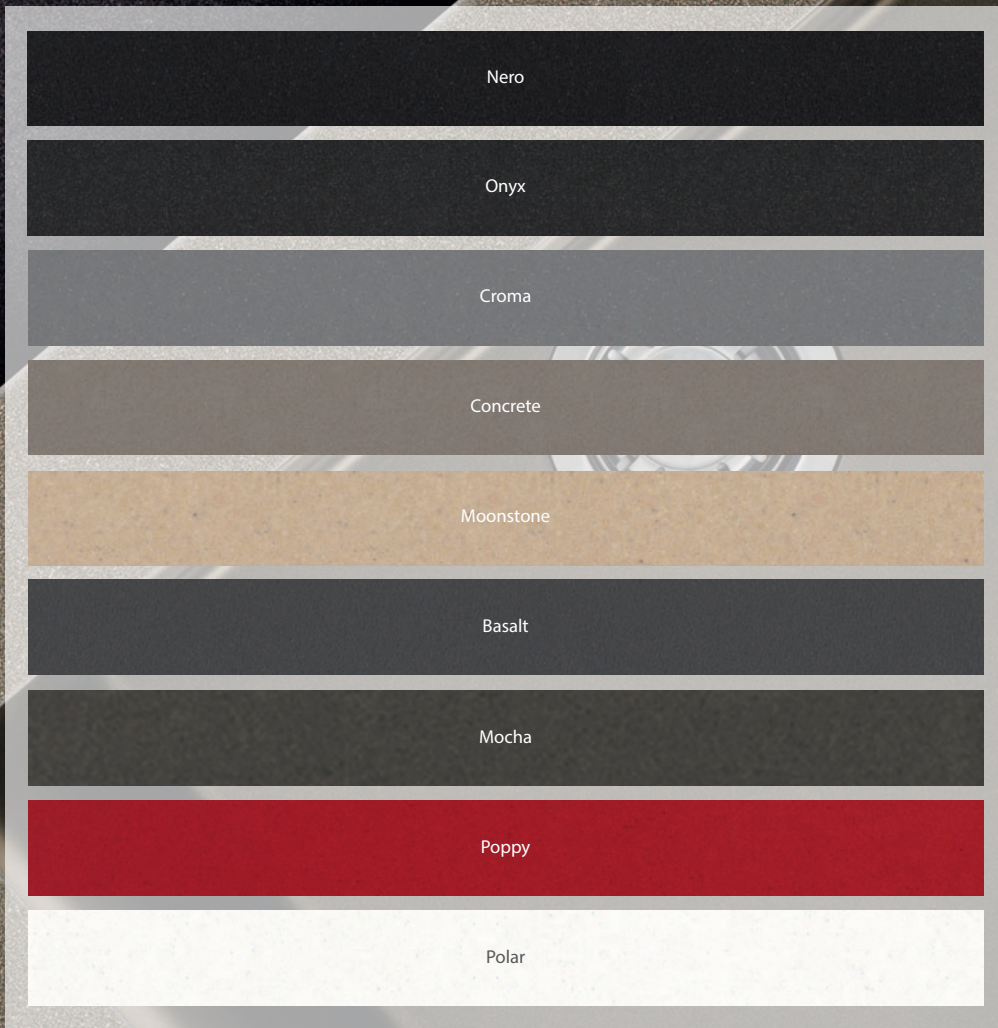

ICONS EXPLAINED

Installation



Inset



Undermount



Reversible



Waste Included

Handing

Other Details



CLEARWATER
GRANITE SINKS
HAVE A LIFETIME
WARRANTY

Matching Wastes Available

Coloured wastes available to match your choice of tap - see following pages.



Artisan Brass



Regency Copper



Gold



Matt Black



Carina 100L in Poppy shown with Magus 4 Electronic kettle tap in Matt Black - see pages 178 -179



Carina Single bowl and drainer

Ref. CAR D100S £360

Overall size: 860/500 mm
 Bowl size: 347/440/200 mm
 Cutout size: 840/480 mm
 Minimum cabinet size: 450 mm
 Standard waste kit included

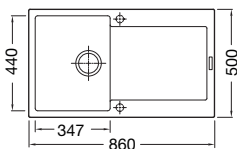

Carina Large bowl and drainer

Ref. CAR D100L £370

Overall size: 1000/500 mm
 Bowl size: 480/440/200 mm
 Cutout size: 980/480 mm
 Minimum cabinet size: 600 mm
 Standard waste kit included

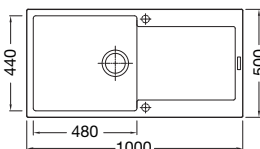

Carina 1.5 bowl and drainer

Ref. CAR D150 £370

Overall size: 1000/500 mm
 Bowl size: 345/440/200 mm
 Half bowl: 155/295/146 mm
 Cutout size: 980/480 mm
 Minimum cabinet size: 600 mm
 Standard waste kit included

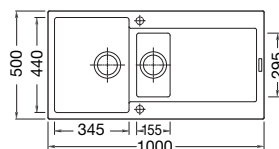

Add colour suffix when ordering

See page 19 for larger colour samples and to learn about the amazing properties of Quarsil®.

- POLAR (PO)
- ONYX (ON)
- MOONSTONE (MS)
- NERO (NE)
- CROMA (CR)
- CONCRETE (CN)
- POPPY (PP)
- BASALT (BA)
- MOCHA (MC)

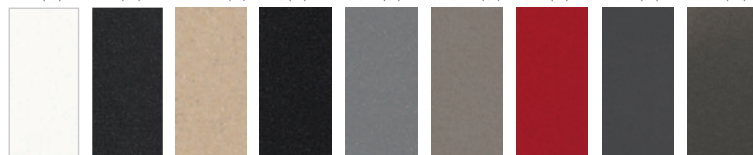



Carina 150 in Cromia shown with Pioneer pull-out tap in Matt Black - see page 248

CARINA QUARSIL®



The **Carina's** smooth drainer and crisp corners offer chic sophistication. The capacious single bowl model is ideal for catering size pans and the popular 1.5 bowl model offers multi-task possibilities.

Available in nine amazing Quarsil® colours including a zingy red for that extra extravagance.

Optional Accessories



Ref. COL107
Colander (Small) £70
Fits half bowl



Ref. COL108
Colander £80
Spans main bowl



Magus 4 Electronic kettle tap in Matt Black - see pages 178 -179

Strainer Wastes

Optional Strainer Wastes

1.0 Bowl = 1 x W900** 1.5 Bowl = 1 x W900** + 1 x W90**



Stainless
supplied
as standard



Artisan Brass
W900AB £69
W90AB £53



Regency Copper
W900RC £69
W90RC £53



Gold
W900G £69
W90G £53



Matt Black
W900MB £69
W90MB £53



Tivoli 150 in Croma shown with Juno tap in Matt Black- see page 228



Tivoli Single bowl and drainer

Ref. TIV D100S £289

Overall size: 860/500 mm
 Bowl size: 347/430/200 mm
 Cutout size: 840/480 mm
 Minimum cabinet size: 450 mm
 Standard waste kit included

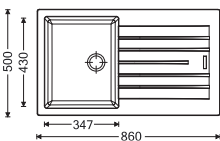

Tivoli Large bowl and drainer

Ref. TIV D100L £299

Overall size: 1000/500 mm
 Bowl size: 480/430/200 mm
 Cutout size: 980/480 mm
 Minimum cabinet size: 600 mm
 Standard waste kit included

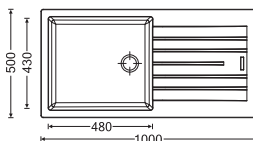

Tivoli 1.5 bowl and drainer

Ref. TIV D150 £299

Overall size: 1000/500 mm
 Bowl size: 345/430/200 mm
 Half bowl: 155/340/146 mm
 Cutout size: 980/480 mm
 Minimum cabinet size: 600 mm
 Standard waste kit included

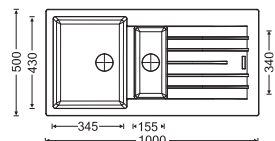



Tivoli 100L in Nero shown with Juno tap in Brushed Brass - see page 228

TIVOLI QUARSIL®



Optional Accessories

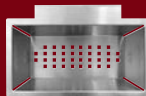

Ref. COL106
Colander £70
Fits half bowl



Ref. COL108
Colander £80
Spans main bowl

The economically priced **Tivoli** is offered in three configurations, so hopefully at least one of the models will be the perfect fit. The ultra-modern design is emphasised by the subtly graduated draining grooves and crisp radius corners and is available in nine fabulous Quarsil® colours. Don't forget to consider including accessories with your sink to add extra versatility.

Strainer Wastes



Stainless
supplied as
standard

Optional Strainer Wastes



Regency Copper
W90ORC £69
W90RC £53



Artisan Brass
W90OAB £69
W90AB £53



Gold
W90OG £69
W90G £53



Matt Black
W90OMB £69
W90MB £53

1.0 Bowl = 1 x W900** 1.5 Bowl = 1 x W900** + 1 x W90**



Juno tap in Brushed Brass - see page 228

POLAR (PO) ONYX (ON) MOONSTONE (MS) NERO (NE) CROMA (CR) CONCRETE (CN) POPPY (PP) BASALT (BA) MOCHA (MC)

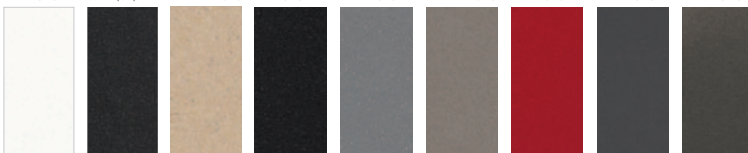

Add colour suffix
when ordering

See page 19 for larger
colour samples and to
learn about the amazing
properties of Quarsil®.



Icons Explained
see page 19.



Strainer Wastes



Stainless
supplied as standard

Optional Strainer Wastes



Artisan Brass
W900AB £69
W90AB £53



Regency Copper
W900RC £69
W90RC £53



Gold
W900G £69
W90G £53



Matt Black
W900MB £69
W90MB £53

1.0 Bowl = 1 x W900**

1.5 Bowl = 1 x W900** + 1 x W90**

Rio 100L in Polar shown with Amelio Sensor tap in Matt Black - see page 216



Rio Large bowl and drainer

Ref. RIO D100L £299

Overall size: 1000/500 mm
Bowl size: 480/430/220 mm
Cut-out size: 980/480 mm
Minimum cabinet size: 600 mm
Standard waste kit included

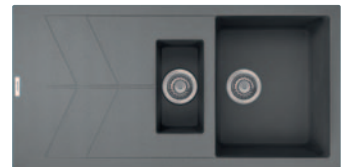
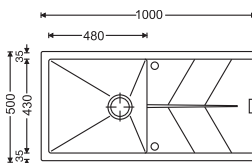

Rio 1.5 bowl and drainer

Ref. RIO D150 £299

Overall size: 1000/500 mm
Bowl size: 347/430/210 mm
Half bowl: 145/285/142 mm
Cut-out size: 980/480 mm
Minimum cabinet size: 600 mm
Standard waste kit included

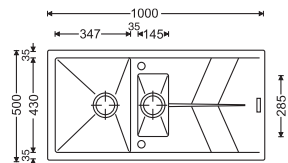



Rio 150 in Basalt shown with Azia Sensor tap in Matt Black - see page 217

RIO QUARSIL®



The **Rio** is an ultra-modern design with a trendy chevron drainer pattern. Both models boast extra deep bowls with draining lines shaped in the bowl base that promote rapid draining.

We have offered nine fantastic Quarsil® colours for this popular sink so colour theming with your kitchen should be a breeze.

Optional Accessories

Ref. COL108
Colander £80
Spans main bowl



Azia Sensor tap in Matt Black - see page 217

POLAR (PO) ONYX (ON) MOONSTONE (MS) NERO (NE) CROMA (CR) CONCRETE (CN) POPPY (PP) BASALT (BA) MOCHA (MC)

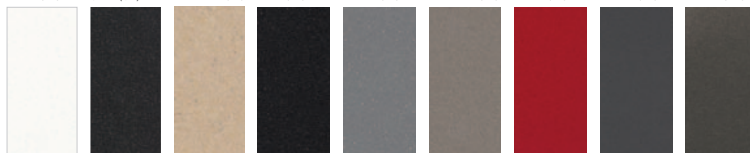

Add colour suffix when ordering
See page 19 for larger colour samples and to learn about the amazing properties of Quarsil®.



Icons Explained
see page 19.



Siena 1.5 in Croma shown with Pioneer tap in Chrome- see page 229



Siena 1.5 in Onyx shown as inset

SIENA QUARSIL®



The **Siena 150** ticks a lot of the boxes on a kitchen designer's wish list; cool contemporary design, sharp radius corners, generous bowl dimensions, and fits within a 60cm cabinet - a perfect solution when space is an issue. Siena bowls can be installed as undermount or inset.

This versatile sink can be fitted as left or right hand main bowl. Added to this, it boasts the widest colour palette available today.



Siena 1.5 bowl (Reversible)
Ref. SIE N150 £342

Overall size: 555/460 mm
Bowl size: 335/400/200 mm
Half bowl: 155/400/140 mm
Cutout size: Template Available
Minimum cabinet size: 600 mm
Standard waste kit included

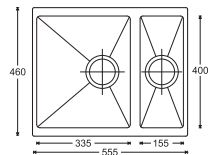

Strainer Wastes



Stainless supplied as standard

Optional Strainer Wastes



Artisan Brass
W900AB £69
W90AB £53



Regency Copper
W900RC £69
W90RC £53



Gold
W900G £69
W90G £53



Matt Black
W900MB £69
W90MB £53

1.0 Bowl = 1 x W900** 1.5 Bowl = 1 x W900** + 1 x W90**



Siena single bowls come in three size options, nine Quarsil® colours to suit most individual requirements and can be installed as undermount or inset. The fine radius corners add to the Siena's cool styling which can be made super cool by choosing a coordinating tap and waste in trend-setting PVD and black finishes.

- The purist's first choice to attain the ultimate minimalist effect
- Easy wipe-down surfaces with no raised edges
- Installation in solid surface worktops only – wood, stone, granite, synthetic

Siena 500 in Polar shown with Amelio Sensor tap in Brushed Brass - see page 216



Siena Single bowl
Ref. **SIE N340** £301

Overall size: 370/460 mm
Bowl size: 340/400/200 mm
Cutout size: Template Available
Minimum cabinet size: 450 mm
Standard waste kit included

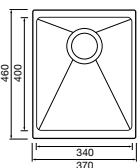

Siena Single bowl
Ref. **SIE N400** £307

Overall size: 430/460 mm
Bowl size: 400/400/200 mm
Cutout size: Template Available
Minimum cabinet size: 500 mm
Standard waste kit included

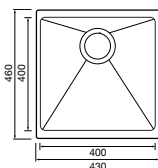

Siena Single bowl
Ref. **SIE N500** £314

Overall size: 530/460 mm
Bowl size: 500/400/200 mm
Cutout size: Template Available
Minimum cabinet size: 600 mm
Standard waste kit included

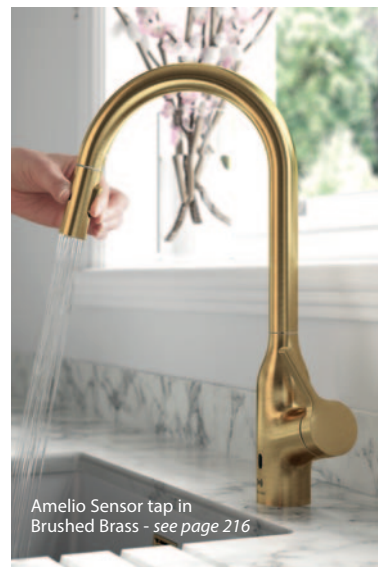
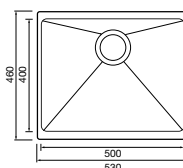

Amelio Sensor tap in
Brushed Brass - see page 216

POLAR (PO) ONYX (ON) MOONSTONE (MS) NERO (NE) CROMA (CR) CONCRETE (CN) POPPY (PP) BASALT (BA) MOCHA (MC)

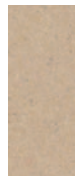

Add colour suffix when ordering
See page 19 for larger colour samples and to learn about the amazing properties of Quarsil®.



Icons Explained
see page 19.



CERAMIC SINKS



Inset

This installation requires the sink to be mounted into the worktop from the top. This installation type is suitable for all types of worktop including laminated chipboard.



Undermount

This installation requires the sink to be fitted to the worktop from the underside. This installation type is only suitable for solid surface worktops such as Granite, Marble or Wood.



Apron Front

In this installation the sink is fitted directly on to a cabinet with its front fascia exposed. This type of installation is only suitable for solid surface worktops such as Granite, Marble or Wood.



ALL THOMAS DENBY & CERAMIC SINKS HAVE A LIFETIME WARRANTY

Ceramic

Tap Holes

Chargeable knock-out service available on request

Icons Explained

Installation



Inset (Flat)



Undermount



Butler

Handing



Left & Right Versions



Reversible

Other Details



Waste Included



Pop-Up Waste Included

Nano - Tech



Is the process of applying an ultra thin surface layer which gives the product a mechanically flat surface making it -

- Dirt Repellent & Hygienic
- Hydrophobic
- Chemical Resistance
- Ultraviolet Resistance
- Reduces grease and finger marks

Used on the following Ceramic sinks - Lydian Chef, Melody Pro, Harmony and Opus.

PRODUCT BENEFITS

Heat Resistant: Ceramic is heat resistant to 1200° centigrade - this means pots from the stove and casserole dishes straight from the oven can safely rest on a ceramic sink.

Hygienic: Totally non-porous, the ultra smooth surface is the most hygienic material for sinks and the easiest to keep clean.

Chemical Resistant: Resistant to all household chemicals including neat bleach.

Extreme Hardness: Extremely resistant to impact, the surface is so hard cutlery won't scratch the glazed surface through normal use.



Dirt-repellent effect



Odour-free



Heat-resistant 180°C



Food-safe



Hygienic Surface



Made to last



Stain-resistant



Impact-resistant



Clearwater Cast Iron and Ceramic Cleaner
Ref. CLEC200 £14
Removes stubborn metal marks and stains with little effort

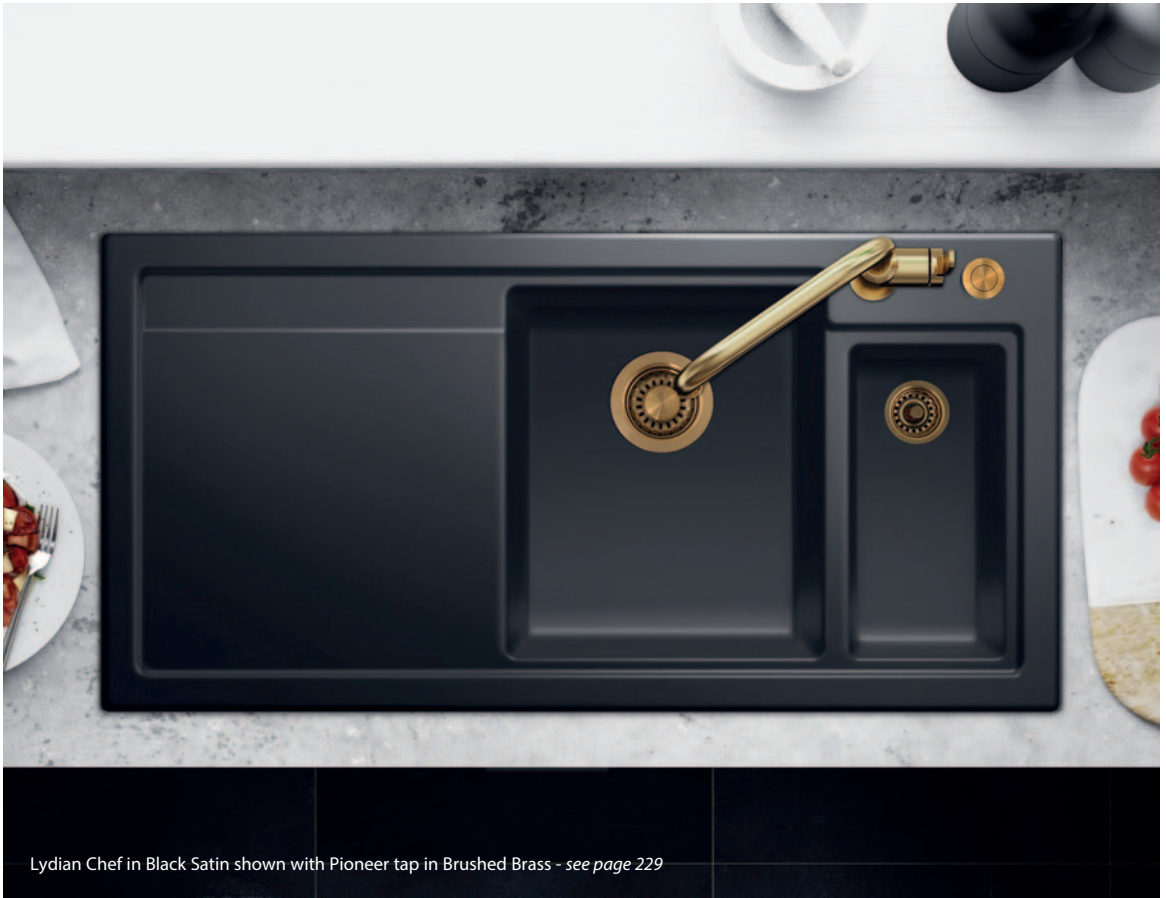

Lydian Chef in Black Satin shown with Pioneer tap in Brushed Brass - see page 229



Topaz tap in Needle Jet mode - see page 222-223

Presto Automatic Waste Kits

For full details about the Presto Automatic Waste see page 159



Chrome
WP15CP £48



Stainless Steel
WP15SS £48



Artisan Brass
WP15AB £116



Regency Copper
WP15RC £114



Matt Black
WP15MB £79



Lydian Chef in White Gloss shown with Topaz tap in Brushed Brass - see page 222-223



Lydian Chef 1.5 bowl and drainer

Ref. LYD1020L left hand drainer
White **£672** Colours **£698**

Ref. LYD1020R right hand drainer
White **£672** Colours **£698**

Sink prices exclude waste, see choice of finishes

Installation: Inset

Overall size: 1000/510 mm

Bowl size: 332/395/185 mm

Half bowl: 161/332/140 mm

Cutout size: 977/488 mm

Minimum cabinet size: 600 mm

Tap-holes: 1 handed

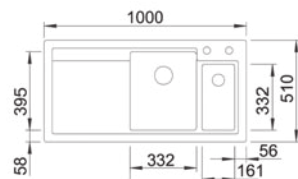

LYDIAN CHEF



The **Lydian Chef** combines smart aesthetics with a carefully considered ergonomic design. The large bowl and outset half-bowl bear the signature of a professional kitchen.

The highest quality finishes have been a priority and special attention is given during the manufacturing process to ensure perfectly smooth surfaces and engineered straight edges. The fired glazed surfaces in white gloss or coloured satin finishes are particularly fine and complete this sink's impressive credentials.

- Slim-edge profile provides a smooth transition to the worktop
- Uniquely practical outset half-bowl for rinsing and draining
- Tap and automatic waste control positioned neatly behind half bowl for clutter-free lines
- Anti-bac, acid and heat resistant surface

WHITE GLOSS (WH) BLACK SATIN (BL) BASALT SATIN (BA)

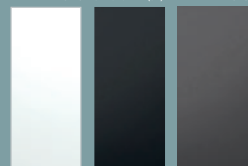

Add colour suffix when ordering

Optional Accessories



Ref. WBD426
Wooden Chopping Board **£34**



Ref. COL103
Stainless Steel Colander **£109**
Fits main bowl



Ref. COL106
Colander **£70**
Fits half bowl



Melody Pro in Basalt Satin shown with Toledo pull-out Filtrertap in Brushed Nickel - see page 197

Presto Automatic Waste Kits

For full details about the Presto Automatic Waste see page 159



Chrome
WP15CP £48



Stainless Steel
WP15SS £48



Artisan Brass
WP15AB £116



Regency Copper
WP15RC £114



Matt Black
WP15MB £79



Toledo tap extended



Melody Pro 1.5 bowl & drainer

Ref. MEL1020 White £492

Ref. MEL1020 Colours £517

Sink prices exclude waste, see choice of finishes

Installation: Inset

Overall size: 1000/510 mm

Bowl size: 360/434/185 mm

Half bowl: 132/330/85 mm

Cutout size: 964/474 mm

Minimum cabinet size: 600 mm

Tap-holes: 1 reversible

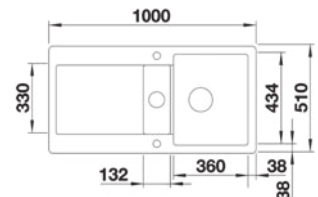



Melody Pro in White Gloss shown with Stella Filter tap in Brushed Brass - see pages 202-203

MELODY PRO



The **Melody's** understated design with its minimalist drainer and the thin profile edges harmonise beautifully, resulting in a highly cool and practical sink. As the Melody is one of our premiere quality ceramics the finish quality sets it apart from its peers.

- Slim-edge profile provides a smooth transition to the worktop
- Understated styling provide an ultra-modern aesthetic
- Slender half bowl allows maximisation of main bowl
- Anti-bac, acid and heat resistant surface

WHITE GLOSS (WH) BLACK SATIN (BL) BASALT SATIN (BA)

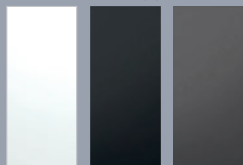

Add colour suffix when ordering



Stella Filter tap in Brushed Brass - see pages 202-203



Harmony XL in White Gloss shown with Krypton Filter tap in Brushed Brass - see page 204

HARMONY



The **Harmony** is a family of four, all sharing smart twin draining channels and distinctive semi-circular tap platforms. These sinks are part of our premiere range and are set apart from other ceramic sinks with their near flawless finish and elegant lines.

The Harmony MB is the flagship model for multi-tasking, with a large main bowl and an invaluable half bowl for rinsing and draining.

The Harmony XL is the largest of the single bowl collection with a high-capacity bowl and expansive draining area, an ideal choice to handle range cooker size trays and oversize pots.

The Harmony XW is mid-size single bowl sink with a drainer waste positioned in a highly useful draining recess, a perfect solution for the disposal of liquids when the bowl is in use.

The Harmony Compact's very compact dimensions offer the opportunity to fit a premiere quality ceramic sink in the smallest of spaces and still provide useful size work zones.



The XW sink has a highly useful draining recess, a perfect solution for the disposal of liquids when the bowl is in use.



Krypton Filter Tap

WHITE GLOSS (WH) BLACK SATIN (BL) BASALT SATIN (BA)

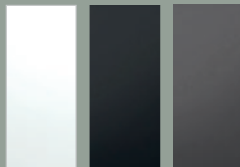

Add colour suffix when ordering

Presto Automatic Waste Kits

For full details about the Presto Automatic Waste see page 159



Chrome
WP10CP £44
WP15CP £48
WP12CP £43



Stainless Steel
WP10SS £44
WP15SS £48
WP12SS £43



Artisan Brass
WP10AB £114
WP15AB £116
WP12AB £94



Regency Copper
WP10RC £114
WP15RC £114
WP12RC £94



Matt Black
WP10MB £75
WP15MB £79
WP12MB £68

Harmony MB
WP15**

Harmony XL
WP10**

Harmony Compact
WP10**

Harmony XW
WP12**



Harmony MB in Basalt Satin shown with Topaz tap in Brushed Nickel- see page 223

Harmony MB 1.5 bowl and drainer

Ref. HAR1020 White £480

Ref. HAR1020 Colours £505

Sink prices exclude waste, see choice of finishes

Installation: Inset

Overall size: 1000/500 mm

Bowl size: 350/420/185 mm

Half bowl: 150/420/100 mm

Cutout size: 977/478 mm

Minimum cabinet size: 600 mm

Tap-holes: 1 reversible

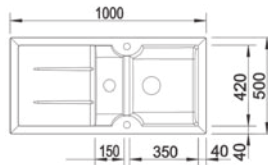

Harmony XL Large bowl and drainer

Ref. HAR1010 White £499

Ref. HAR1010 Colours £524

Sink prices exclude waste, see choice of finishes

Installation: Inset

Overall size: 1000/500 mm

Bowl size: 480/420/175 mm

Cutout size: 977/477 mm

Minimum cabinet size: 600 mm

Tap-holes: 1 reversible

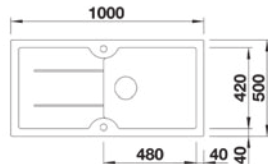

Harmony XW Single Bowl and drainer

Ref. HAR9110 White £440

Ref. HAR9110 Colours £462

Sink prices exclude waste, see choice of finishes

Installation: Inset

Overall size: 915/500 mm

Bowl size: 352/420/187 mm

Cutout size: 892/478 mm

Minimum cabinet size: 500 mm

Tap-holes: 1 reversible

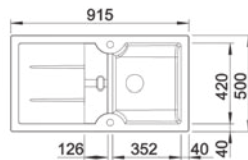

Harmony Compact Small bowl & drainer

Ref. HAR7810 White £405

Ref. HAR7810 Colours £426

Sink prices exclude waste, see choice of finishes

Installation: Inset

Overall size: 780/500 mm

Bowl size: 350/420/175 mm

Cutout size: 758/478 mm

Minimum cabinet size: 450 mm

Tap-holes: 1 reversible

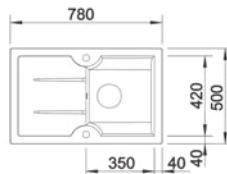



Opus XL in Black Satin shown with Kira pull-out tap in Chrome - see pages 245



Presto Automatic Waste Kits

For full details about the Presto Automatic Waste see page 159



Chrome
WP10CP £48



Stainless Steel
WP10SS 48



Artisan Brass
WP10AB £114



Regency Copper
WP10RC £114



Matt Black
WP10MB £75



Opus XL Large bowl & drainer

Ref. OPU1010L left hand drainer
White £510 Colours £536

Ref. OPU1010R right hand drainer
White £510 Colours £536

Sink prices exclude waste, see choice of finishes

Installation: Inset
Overall size: 1000/510 mm
Bowl size: 465/348/185 mm
Cutout size: 977/488 mm
Minimum cabinet size: 600 mm
Tap-holes: 1 handed

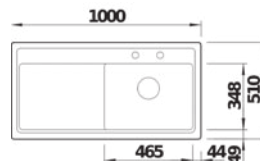

Opus Compact Small bowl & drainer

Ref. OPU861L left hand drainer
White £440 Colours £463

Ref. OPU861R right hand drainer
White £440 Colours £463

Sink prices exclude waste, see choice of finishes

Installation: Inset
Overall size: 860/510 mm
Bowl size: 378/348/185 mm
Cutout size: 837/488 mm
Minimum cabinet size: 450 mm
Tap-holes: 1 handed

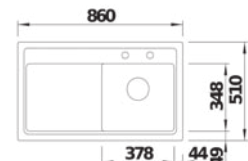



Opus XL in Black Satin shown with Kira pull-out tap in Chrome - see pages 245

OPUS



The **Opus** is designed with a distinctive linear tap ledge that compliments its minimalist drainer. Both models share a premiere build quality with sublime glazing that define these sinks. The **Opus Compact** is a great choice when space is at a premium whilst offering useful bowl dimensions. The **Opus XL** has particularly high-capacity bowl and large draining platform thus ensuring this model's high workload status.

- Slim-edge profile provides a smooth transition to the worktop
- Defined linear ledge contains spills and provide a 'dry' platform for accessories
- Compact model fits within 45cm cabinet
- Anti-bac, acid and heat resistant surface

WHITE GLOSS (WH) BLACK SATIN (BL) BASALT SATIN (BA)

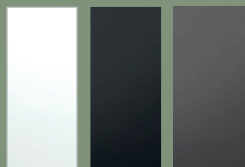

Add colour suffix when ordering



Kira tap extended



Sonnet Single bowl and drainer
Ref. SO1BWT White £308
Ref. SO1BCH Champagne £361
Standard Waste WKIT1 S/S £28

Installation: Inset
 Overall size: 855/500 mm
 Bowl size: 340/370/200 mm
 Cutout size: 815/460 mm
 Minimum cabinet size: 500 mm
 Tap-holes: 1 reversible

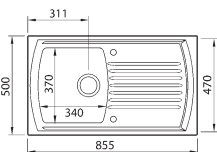

Sonnet 1.5 bowl and drainer
Ref. SO15BWT White £319
Ref. SO15BCH Champagne £368
Standard Waste WKIT2 S/S £52

Installation: Inset
 Overall size: 995/500 mm
 Bowl size: 330/370/210 mm
 Half bowl: 135/253/120 mm
 Cutout size: 950/460 mm
 Minimum cabinet size: 600 mm
 Tap-holes: 1 reversible

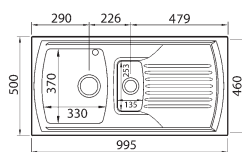

Sonnet Double bowl and drainer
Ref. SO2BDWT White £416
Standard Waste WKIT2 S/S £52

Installation: Inset
 Overall size: 1205/500 mm
 Bowl sizes: 335/373/200 mm
 Cutout size: 1170/465 mm
 Minimum cabinet size: 800 mm
 Tap-holes: 1 reversible

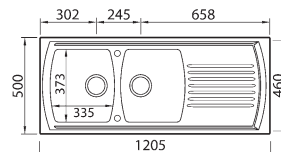



Sonnet SO15BWT shown with Juno tap in chrome - see pages 228

Standard Waste Kits



		Artisan Brass W90OAB £69 W90AB £53		Artisan Brass W60AB £43
		Regency Copper W90ORC £69 W90RC £53		Regency Copper W60RC £43
		Matt Black W90OMB £69 W90MB £53		Matt Black W60MB £37

Optional Coloured Wastes

- 1.0 Bowl = 1 x W900**
- 1.5 Bowl = 1 x W900** + 1 x W60**
- 2.0 Bowl = 2 x W90

SONNET

WHITE CHAMPAGNE

The **Sonnet** will brighten up any kitchen with its stylish contemporary design and smooth curves.



Icons Explained see page 29.



Jarla 1010 shown with Pioneer pull-out tap in Brushed Brass - see page 248



Standard Waste Kit



Artisan Brass
W900AB £69
W90AB £53



Regency Copper
W900RC £69
W90RC £53

Optional Coloured Wastes

1.0 Bowl = 1 x W900**
1.5 Bowl = 2 x W90**



Matt Black
W900MB £69
W90MB £53



Jarla Mini Single bowl and drainer
Ref. JAR1030 White £316
Standard Waste WKIT1 S/S £28

Installation: Inset
Overall size: 857/500/215 mm
Bowl size: 417/412/190 mm
Cutout size: 840/480 mm
Minimum cabinet size: 600 mm
Tap-Holes: 1 reversible

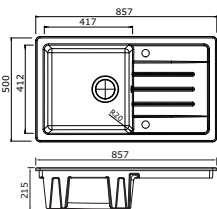

Jarla Single bowl and drainer
Ref. JAR1010 White £361
Ref. JAR1010B Black £390
Standard Waste WKIT1 S/S £28

Installation: Inset
Overall size: 1000/500/210 mm
Bowl size: 447/412/195 mm
Cutout size: 980/480 mm
Minimum cabinet size: 600 mm
Tap-Holes: 1 reversible

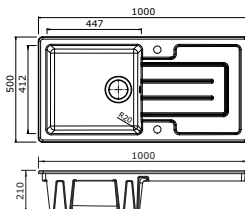

Jarla 1.5 bowl and drainer
Ref. JAR1020 White £386
Ref. JAR1020B Black £425
Standard Waste WKIT2 S/S £52

Installation: Inset
Overall size: 1000/500/210 mm
Bowl size: 340/415/190 mm
Half bowl: 170/299/142 mm
Cutout size: 980/480 mm
Minimum cabinet size: 600 mm
Tap-Holes: 1 reversible

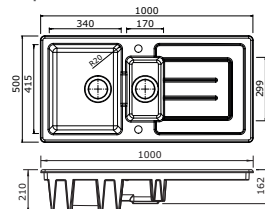



Jarla 1020 shown with Mariner filter tap in Matt Black - see pages 194 -195

JARLA



The **Jarla** are Denby's latest addition of contemporary sinks. The design brief was to offer a slim-edge profile together with 20mm radius bowls resulting in a very smart design which combined with the highest quality finish makes this a superb choice for your home.



Jarla Mini shown with Magus 3 Kettle tap in Chrome - see page 176 -177



Icons Explained
see page 29.

Metro 1.5 bowl

Ref. MET1020 White £381

Ref. MET1020G Sea Mist £482

Standard Waste WKIT2 S/S £52

Installation: Inset or Undermount

Overall size: 595/460 mm

Bowl size: 326/390/194 mm

Half bowl: 172/390/194 mm

Cutout size: Template available

Minimum cabinet size:

600 mm (Inset) 700 mm (Undermount)

Tap-holes: No

MET1020
White
is reversible.

MET1020G
Sea Mist
is left hand
main bowl
only.

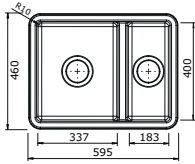

MET1020G Sea Mist Wastes
1 x W900** + 1 x W90**
(Has overflow)

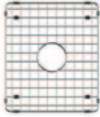

Metro 1020 Grid
Ref. Grid20 £50



Metro 1020 pictured with grid



Metro 1020 pictured in Sea Mist



Metro 1070 shown with Karuma pull-out tap in Chrome - see page 246

Metro 1.5 bowl (Reversible)

Ref. MET1070 White £381

Standard Waste WKIT2 S/S £52

Installation: Inset or Undermount

Overall size: 555/430 mm

Bowl size: 330/370/195 mm

Half bowl: 150/370/195 mm

Cutout size: Template available

Minimum cabinet size: 600 mm

Tap-holes: No

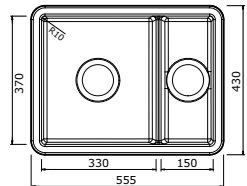



METRO

UNDERMOUNT/INSET



The **Metro** collection are a versatile range of bowls that can be installed as either undermount or inset installations. There are three single bowl options to select, choose a stand alone or even a combination of two together. The multi-combined bowl option is particularly smart with extra-slim partition walls providing a more sophisticated look than other ceramic options. Metro sinks are available in gloss White and matt Sea Mist.

Standard Waste Kit



WHITE SEA MIST



Optional Coloured Wastes

- 1.0 Bowl = 1 x W900**
- 1.3 Bowl = 1 x W900** + 1 x W90**
- 1.5 Bowl = 2 x W90** (No overflow)

-  Artisan Brass
W900AB £69
W90AB £53
-  Regency Copper
W900RC £69
W90RC £53
-  Matt Black
W900MB £69
W90MB £53



Metro 1070 shown with Karuma pull-out tap in Chrome - see page 246

Metro 1.3 bowl (left hand main bowl only)

Ref. MET1010 White £381
Standard Waste WKIT2 S/S £52

Installation: Inset or Undermount
Overall size: 595/520 mm
Bowl size: 350/450/194 mm
Third bowl: 162/290/194 mm
Cutout size: Template available
Minimum cabinet size:
600 mm (Inset) 700 mm (Undermount)
Tap-holes: No

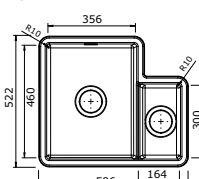
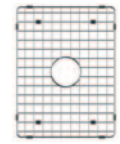
Metro 1010 Grid
Ref. Grid10 £63



Icons Explained
see page 29.

clearwater



Metro Half bowl

Ref. MET1030 White £230
Standard Waste WKIT1 S/S £28

Installation: Inset or Undermount
Overall size: 234/460 mm
Bowl size: 174/400/194 mm
Cutout size: Template available
Minimum cabinet size: 300 mm
Tap-Holes: No

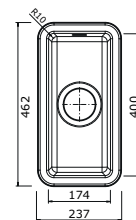

Metro Medium bowl

Ref. MET1040 White £278
Ref. MET1040G Sea Mist £361
Standard Waste WKIT1 S/S £28

Installation: Inset or Undermount
Overall size: 460/460 mm
Bowl size: 400/400/194 mm
Cutout size: Template available
Minimum cabinet size: 500 mm
Tap-Holes: No

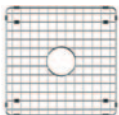
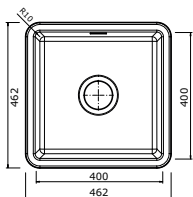

Metro 1040 Grid
Ref. Grid40 £63





Metro Large bowl

Ref. MET1050 White £381
Ref. MET1050G Sea Mist £482
Standard Waste WKIT1 S/S £28

Installation: Inset or Undermount
 Overall size: 595/460 mm
 Bowl size: 535/400/194 mm
 Cutout size: Template available
 Minimum cabinet size:
 600 mm (Inset) 700 mm (Undermount)
 Tap-Holes: No

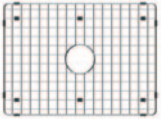
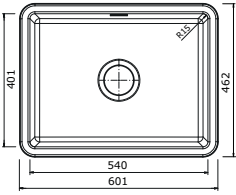

Metro 1050 Grid
Ref. Grid50 £75



Metro 1050 pictured with grid

WHITE



SEA MIST



Standard Waste Kit



Optional Coloured Wastes

1.0 Bowl = 1 x W900**
 1.3 Bowl = 1 x W900**
 + 1 x W90**
 1.5 Bowl = 2 x W90**
 (No overflow)



Metro Round bowl

Ref. MET1060 White £257
Ref. MET1060G Sea Mist £349
Standard Waste WKIT1 S/S £28

Installation: Inset or Undermount
 Overall size: 445/445 mm
 Bowl size: 384/384/172 mm
 Cutout size: Template available
 Minimum cabinet size: 450 mm
 Tap-Holes: No

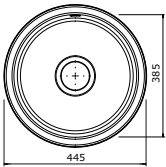



Avola 150 in White Gloss shown with Asia Pro tap in Chrome - see page 252-253

	Chrome W900C £30		Chrome W60C £27
	Artisan Brass W900AB £69		Artisan Brass W60AB £43
	Regency Copper W900RC £69		Regency Copper W60RC £43
	Matt Black W900MB £69		Matt Black W60MB £37

1.0 Bowl = 1 x W900** 1.5 Bowl = 1 x W900** + 1 x W60**

AVOLA UNDERMOUNT

The **Avola** is our premiere ceramic range of undermounts, manufactured to the highest of tolerances ensuring faultlessly smooth surfaces and beautiful glazed finishes. There are three single bowls ranging in size from compact to catering size. There is a smart 1.5 bowl model which is extremely versatile and very usefully fits within a 60cm cabinet - perfect when space is at a premium. Available in a sparkling white gloss and two dark matt colours that will add drama to the kitchen.

WHITE GLOSS (WH) BLACK SATIN (BL) BASALT SATIN (BA)

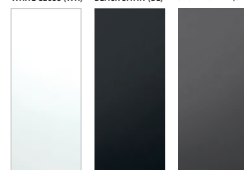

Add colour suffix when ordering



Avola 1.5 bowl
Ref. AVO U150 White £489
Ref. AVO U150 Colours £519

Overall size: 567/456 mm
 Bowl size: 350/396/185 mm
 Half bowl: 150/396/130 mm
 Cutout size: Template Available
 Minimum cabinet size: 600 mm

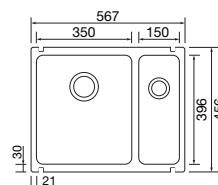

Asia Pro tap in Needle Jet mode





Avola 500 in Black Satin shown with Santor pull-out tap in Brushed Brass - see page 247



Santor pull-out tap extended - see page 247



Avola Single bowl
Ref. AVO U375 White £419
Ref. AVO U375 Colours £449
 Overall size: 414/456 mm
 Bowl size: 374/396/185 mm
 Cutout size: Template Available
 Minimum cabinet size: 450 mm

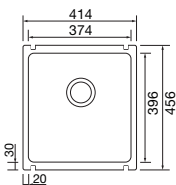

Avola Single bowl
Ref. AVO U500 White £479
Ref. AVO U500 Colours £509
 Overall size: 543/456 mm
 Bowl size: 500/396/185 mm
 Cutout size: Template Available
 Minimum cabinet size: 600 mm

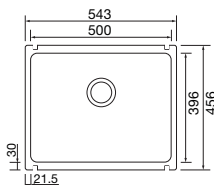

Avola Single bowl
Ref. AVO U700 White £529
Ref. AVO U700 Colours £559
 Overall size: 751/456 mm
 Bowl size: 700/396/203 mm
 Cutout size: Template Available
 Minimum cabinet size: 800 mm

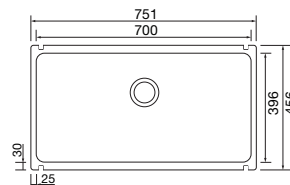

Icons Explained
 see page 29.

APRON FRONTED

The following pages contain a comprehensive collection of Butler sinks. We offer two main ranges; our 'British Classics' are quintessential vintage designs which are handmade by skilled artisans, while our 'Contemporary Collection' gives a modern tilt to the traditional Butler sink. We also include some practical utilitarian sinks that are ideal for the utility or boot room.



In this installation the sink is fitted directly onto a cabinet with its front fascia exposed.

This type of installation is only suitable for solid surface worktops such as Granite, Marble or Wood.



BRITISH CLASSICS

Pages 49 - 61

Our British Classics are a collection of handmade sinks using traditional methods by skilled artisans who pride themselves in reproducing heritage icons.



- Timeless appeal
- Soft sculpture profiles
- Traditional thick walls
- Solid wall construction
- Glazed twice for a beautiful surface finish
- Hand-made by skilled Artisans
- Made in Britain

CONTEMPORARY COLLECTION

Pages 62 - 66

Our Contemporary Collection is a modern interpretation of the classic Butler sink. The use of modern manufacturing techniques has resulted in a slimmer profiled design bringing a layer of modernity to these traditional classics.



- Slim-profile walls
- Light weight construction
- Suitable for modern and traditional styles

UTILITY & LAUNDRY

Pages 66 - 67





Belfast shown with Davina Twist & Spray tap in Chrome - see page 226

BELFAST BRITISH CLASSICS

This British Classics **Belfast** faithfully follows the original architectural lines of its forebears, boasting thick softly profiled walls with a classic weir overflow.

KEY FEATURES

- 60mm waste outlet
- Lifetime warranty
- Luxurious, durable, anti-bacterial glaze finish
- Handmade by Master Craftsmen

Belfast Waste Options (85mm Flange)



60mm Waste
Ref. **WRPC**
Stainless **£30**



60mm PVD Waste
Ref. **WRPAB**
Artisan Brass **£47**



60mm PVD Waste
Ref. **WRPRC**
Regency Copper **£47**



60mm PVD Waste
Ref. **W60G**
Gold **£47**



Belfast Single bowl
Ref. **TBE600** White **£483**
Installation: Apron Front
Overall size: 595/460/255 mm
Bowl size: 525/390/217 mm
Overflow: Yes
Tap-holes: No

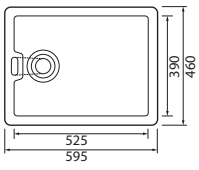

Belfast Mini Single bowl
Ref. **TBE460** White **£458**
Installation: Apron Front
Overall size: 460/380/205 mm
Bowl size: 390/310/180 mm
Overflow: Yes
Tap-holes: No

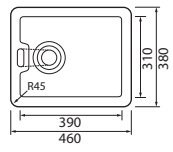

Belfast Mini



Oxford shown with Thomas Denby waste in Brushed Steel



OXFORD BRITISH CLASSICS

The **Oxford** has a more modern design with its rectilinear lines. It has a strong presence in the kitchen with its deep apron front and capacious dimensions.

- 90mm waste outlet
- Lifetime warranty
- Luxurious, durable, anti-bacterial glaze finish
- Handmade by Master Craftsmen

Thomas Denby Wastes



Chrome
TD1WC £61



Bronze PVD
TD1WBR £106



Brushed Steel
TD1WBS £68



Regency
Copper PVD
TD1WRC £106



Polished
Nickel PVD
TD1WNI £106



Brushed
Brass PVD
TD1WBB £106



Oxford shown with Elegance Twist & Spray tap in Brushed Nickel - see page 307



Oxford Single bowl
Ref. **TOX600** White £465

Installation: Apron Front
Overall size: 595/465/230 mm
Bowl size: 535/405/199 mm
Overflow: Yes
Tap-holes: No

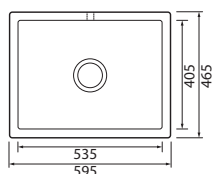



NORFOLK BRITISH CLASSICS

The **Norfolk** has all the DNA of the traditional Belfast but with the quintessential weir overflow positioned at the rear instead of the side wall. This symmetrical arrangement adds a more contemporary look to this classic sink.

- 60mm waste outlet
- Lifetime warranty
- Luxurious, durable, anti-bacterial glaze finish
- Handmade by Master Craftsmen

Norfolk Waste Options (85mm Flange)



60mm Waste
Ref. WRPC
Stainless **£30**



60mm PVD Waste
Ref. WRPAB
Artisan Brass **£47**



60mm PVD Waste
Ref. WRPRC
Regency Copper **£47**



60mm PVD Waste
Ref. W60G
Gold **£47**

Norfolk shown with Elegance Bridge Twist & Spray tap in Brushed Bronze - see page 307



Norfolk Single bowl
Ref. **TNO600** White **£559**

Installation: Apron Front
Overall size: 595/460/229 mm
Bowl size: 525/390/199 mm
Overflow: Yes
Tap-holes: No

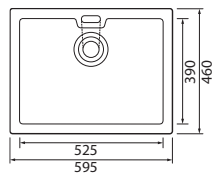

Norfolk shown with Traditional Pull-Out Spray in Brushed Bronze - see page 263



Essex shown with Elegance Twist & Spray tap in Chrome - see page 307

ESSEX BRITISH CLASSICS

The **Essex** is our biggest single bowl sink in the British Classics collection and offers a spacious bowl for serious scullery drudgery! This centre piece sink will bring splendour to your kitchen with its beautifully handcrafted lines and lustrous finish.

- 90mm waste outlet
- Lifetime warranty
- Luxurious, durable, anti-bacterial glaze finish
- Handmade by Master Craftsmen

Thomas Denby Wastes



Chrome
TD1WC £61



Bronze PVD
TD1WBR £106



Brushed Steel
TD1WBS £68



Regency
Copper PVD
TD1WRC £106



Polished
Nickel PVD
TD1WNI £106



Brushed
Brass PVD
TD1WBB £106



Essex Single bowl
Ref. **TES800** White £918
Installation: Apron Front
Overall size: 795/460/254 mm
Bowl size: 735/400/224 mm
Overflow: Yes
Tap-holes: No

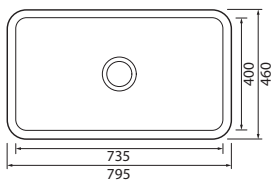

Elegance tap - see page 307



TUDOR BRITISH CLASSICS

The **Tudor** is our most compact twin bowl Farmhouse and an ideal choice for less than huge kitchens whilst retaining generous bowl sizes for heavy duties. The traditional solid wall construction is hand crafted with brilliant bright glaze giving the Tudor its air of authority.

- 90mm waste outlet
- Lifetime warranty
- Luxurious, durable, anti-bacterial glaze finish
- Handmade by Master Craftsmen

Tudor shown with Thomas Denby wastes in Brushed Brass



Tudor Double bowl
Ref. TTU800 White £918
 Installation: Apron Front
 Overall size: 800/500/220 mm
 Bowl sizes: 365/440/195 mm
 Overflow: Yes
 Tap-holes: No

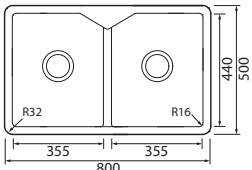

Thomas Denby Wastes

		
Chrome TD2WC £113	Bronze PVD TD2WBR £190	Brushed Steel TD2WBS £129
		
Regency Copper PVD TD2WRC £190	Polished Nickel PVD TD2WNI £190	Brushed Brass PVD TD2WBB £190



Tudor shown with Elegance Bridge Twist & Spray tap in Brushed Bronze - see page 307



Windsor shown with Thomas Denby waste in Brushed Brass

WINDSOR BRITISH CLASSICS

The **Windsor's** soft contours and chunky walls exude an individual charm. The bowl is broad but the depth is shallower than its peers in the British Classic collection.

- 90mm waste outlet
- Lifetime warranty
- Luxurious, durable, anti-bacterial glaze finish
- Handmade by Master Craftsmen



Windsor Single bowl
Ref. TW1600 White **£465**
 Installation: Apron Front
 Overall size: 595/460/200 mm
 Bowl size: 535/400/170 mm
 Overflow: Yes
 Tap-holes: No

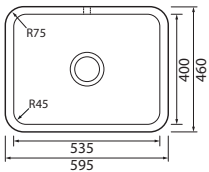

Thomas Denby Wastes



Chrome
 TD1WC £61



Bronze PVD
 TD1WBR £106



Brushed Steel
 TD1WBS £68



Regency Copper PVD
 TD1WRC £106



Polished Nickel PVD
 TD1WNI £106



Brushed Brass PVD
 TD1WBB £106



Windsor shown with Elegance tap in Brushed Brass - see page 307



Chiltern shown with Magus 4 Kettle tap in Matt Black - see page 178 -179

CHILTERN BRITISH CLASSICS

The **Chiltern** is the sister sink to the Windsor, but with a cravat! This flamboyant Belfast will add a characterful presence to your kitchen and is sure to attract many compliments at your next kitchen soirée.

- 90mm waste outlet
- Lifetime warranty
- Luxurious, durable, anti-bacterial glaze finish
- Handmade by Master Craftsmen

Thomas Denby Wastes

		
Chrome TD1WC £61	Bronze PVD TD1WBR £106	Brushed Steel TD1WBS £68
		
Regency Copper PVD TD1WRC £106	Polished Nickel PVD TD1WNI £106	Brushed Brass PVD TD1WBB £106



Chiltern Single bowl
Ref. TCH600 White £665
 Installation: Apron Front
 Overall size: 595/460/230 mm
 Bowl size: 535/400/199 mm
 Overflow: Yes
 Tap-holes: No

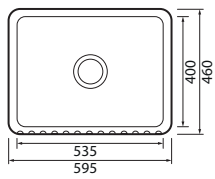

Chiltern shown with Modern Pull-Out Spray in Matt Black - see page 262



Suffolk shown with Elegance Twist & Spray tap in Chrome - see page 307



Suffolk shown with Traditional Pull-Out Spray in Chrome - see page 263



Suffolk 1.5 bowl (Reversible)

Ref. TSU800 White £1056

Installation: Apron Front
 Overall size: 795/465/220 mm
 Bowl size: 500/405/195 mm
 Half bowl: 205/405/195 mm
 Overflow: No
 Tap-holes: No

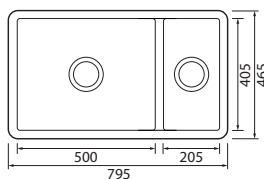

SUFFOLK BRITISH CLASSICS

The **Suffolk** has a useful double bowl with an offset dividing wall. The generously sized main bowl is perfect to take on oversized items for washing while the half bowl is left free for smaller tasks.

- 90mm waste outlet
- Lifetime warranty
- Luxurious, durable, anti-bacterial glaze finish
- Handmade by Master Craftsmen
- Overflow into adjacent bowl facilitated by lower bowl divide
- Reversible LH/RH Main bowl

Thomas Denby Wastes



Chrome
TD2WC £113



Bronze PVD
TD2WBR £190



Brushed Steel
TD2WBS £129



Regency Copper PVD
TD2WRC £190



Polished Nickel PVD
TD2WNI £190



Brushed Brass PVD
TD2WBB £190



Bredon shown with Longdon Kettle tap in Chrome - see page 182 - 183

BREDON BRITISH CLASSICS

The **Bredon** is the sister to the Suffolk Farmhouse and amongst its many attributes is a beautifully fluted facade adding a glamorous style to your home. There are two bowls with dramatically different capacities – a 50cm option to take on big scale items and a compact 20cm providing a desirable water-saving option.

- 90mm waste outlet
- Lifetime warranty
- Luxurious, durable, anti-bacterial glaze finish
- Handmade by Master Craftsmen
- Overflow into adjacent bowl facilitated by lower bowl divide
- Reversible LH/RH Main bowl

Thomas Denby Wastes



Chrome
TD2WC £113



Bronze PVD
TD2WBR £190



Brushed Steel
TD2WBS £129



Regency
Copper PVD
TD2WRC £190



Polished
Nickel PVD
TD2WNI £190



Brushed
Brass PVD
TD2WBB £190



Bredon shown with Traditional Pull-Out Spray in Chrome - see page 263



Bredon 1.5 bowl (Reversible)

Ref. **TBR800** White **£1056**

Installation: Apron Front Fluted
Overall size: 795/465/220 mm
Bowl size: 500/405/195 mm
Half bowl: 205/405/195 mm
Overflow: No
Tap-holes: No

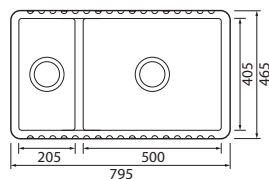



CUMBRIA BRITISH CLASSICS

The **Cumbria** is our biggest Farmhouse sink with two generous equal sized bowls. The soft contours and large scale of the Cumbria create an extravagant opulence that will be the focal point in the grandest of kitchens. If a high workload and twin tasking is required, there is no better choice.

- 90mm waste outlet
- Lifetime warranty
- Luxurious, durable, anti-bacterial glaze finish
- Handmade by Master Craftsmen

Cumbria shown with Thomas Denby wastes in Brushed Brass



Elegance Bridge Twist & Spray tap in Brushed Bronze - see page 307

Thomas Denby Wastes



Chrome
TD2WC £113



Bronze PVD
TD2WBR £190



Brushed Steel
TD2WBS £129



Regency
Copper PVD
TD2WRC £190



Polished
Nickel PVD
TD2WNI £190



Brushed
Brass PVD
TD2WBB £190



Cumbria Double bowl
Ref. **TCU1000** White £1374

Installation: Apron Front
Overall size: 1000/535/220 mm
Bowl sizes: 455/455/190 mm
Overflow: Yes
Tap-holes: No

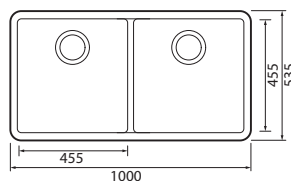



COTSWOLD

BRITISH CLASSICS

The **Cotswold** is the sister sink to the Cumbria, our biggest 100cm Farmhouse and is the flagship of our sink fleet with capacious dimensions and certainly makes a statement with its distinctive fluted façade.

- 90mm waste outlet
- Lifetime warranty
- Luxurious, durable, anti-bacterial glaze finish
- Handmade by Master Craftsmen

Cotswold shown with Stella Filter Tap - see page 202-203 & Pull-Out Spray in Chrome - see page 262



Cotswold Double bowl
Ref. TCT1000 White £1374
 Installation: Apron Front
 Overall size: 1000/535/220 mm
 Bowl sizes: 455/455/190 mm
 Overflow: Yes
 Tap-holes: No

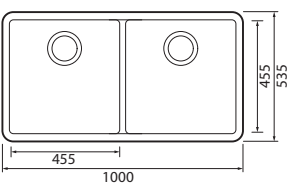

Thomas Denby Wastes

- | | | |
|--|---|---|
| 
Chrome
TD2WC £113 | 
Bronze PVD
TD2WBR £190 | 
Brushed Steel
TD2WBS £129 |
| 
Regency Copper PVD
TD2WRC £190 | 
Polished Nickel PVD
TD2WNI £190 | 
Brushed Brass PVD
TD2WBB £190 |



London Kettle tap - see page 182 - 183 & Pull-Out Spray in Chrome - see page 263



Wessex shown with Elegance Twist & Spray tap in Brushed Brass - see page 307



WESSEX BRITISH CLASSICS

The **Wessex** 'Goldilocks' dimension of 90cm is a great scale for most kitchens providing a strong visual impact and a brilliant workhorse with its capacious twin bowls. This centre piece sink will bring splendour to your kitchen with its beautifully handcrafted lines and lustrous finish.

- 90mm waste outlet
- Lifetime warranty
- Luxurious, durable, anti-bacterial glaze finish
- Handmade by Master Craftsmen

Thomas Denby Wastes



Chrome
TD2WC £113



Bronze PVD
TD2WBR £190



Brushed Steel
TD2WBS £129



Regency
Copper PVD
TD2WRC £190



Polished
Nickel PVD
TD2WNI £190



Brushed
Brass PVD
TD2WBB £190



Wessex Double bowl
Ref. TWE900 White £918
Installation: Apron Front
Overall size: 895/465/229 mm
Bowl sizes: 403/405/199 mm
Overflow: Yes
Tap-holes: No

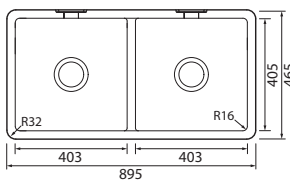



Buxton shown with Traditional Pull-Out Spray in Brushed Brass - see page 263



Buxton Double bowl
Ref. TBU900 White £918
 Installation: Apron Front
 Overall size: 895/465/235 mm
 Bowl sizes: 403/405/199 mm
 Overflow: Yes
 Tap-holes: No

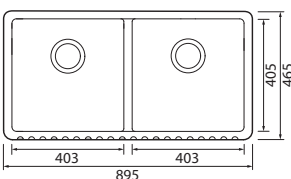

Longdon Kettle tap in Brushed Brass
 - see page 182 -183

BUXTON BRITISH CLASSICS

The **Buxton** is the sister sink to the **Wessex**. This classic Farmhouse offers twin bowls of chore-swallowing dimensions, and at 90cm is a great fit for most kitchens whilst creating a strong focal point with its exquisite, fluted detailing.

- 90mm waste outlet
- Lifetime warranty
- Luxurious, durable, anti-bacterial glaze finish
- Handmade by Master Craftsmen

Thomas Denby Wastes



Chrome
 TD2WC £113



Bronze PVD
 TD2WBR £190



Brushed Steel
 TD2WBS £129



Regency
 Copper PVD
 TD2WRC £190



Polished
 Nickel PVD
 TD2WNI £190



Brushed
 Brass PVD
 TD2WBB £190



LEGACY

The Legacy Butler sinks combine tradition with modernity, the slimmer wall construction gives this classic design a subtle elegance that contrasts with the more robust architecture of the British Classics shown on the preceding pages. We offer two installation options; without a tap ledge, or with a tap platform suitable for a Monobloc mixer tap. This option negates the bother of drilling a hole in the work surface.

Thomas Denby Wastes



Chrome
TD1WC £61



Bronze PVD
TD1WBR £106



Brushed Steel
TD1WBS £68



Regency Copper PVD
TD1WRC £106



Polished Nickel PVD
TD1WNI £106



Brushed Brass PVD
TD1WBB £106

LEGACY 600



Legacy 600 Single bowl

Ref. **LEG600** White **£393**

Standard Waste

WKIT1 S/S £28

Installation: Apron Front
Overall: 595/450/220 mm
Bowl size: 551/406/198 mm
Overflow: No
Tap-Holes: No
Weight: 31kg

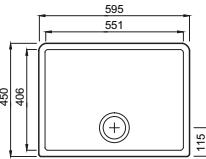

Legacy 600 shown with Alrish tap in Chrome - see page 311



Legacy 800T shown with Alrish tap in Chrome - see page 311

LEGACY 600T & 800T



Legacy 600T Single bowl with Tap Ledge

Ref. **LEG600T** White **£393**

Standard Waste

WKIT1 S/S £28

Installation: Apron Front
Overall: 595/450/220 mm
Bowl size: 551/406/198 mm
Overflow: No Weight: 31kg
Tap-Holes: 1
(available without tap hole by Special Order)

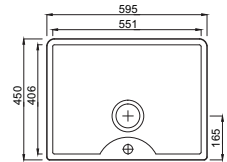

Legacy 800T Single bowl with Tap Ledge

Ref. **LEG800T** White **£492**

Standard Waste

WKIT1 S/S £28

Installation: Apron Front
Overall: 795/500/220 mm
Bowl size: 751/456/198 mm
Overflow: No Weight: 41kg
Tap-Holes: 1
(available without tap hole by Special Order)

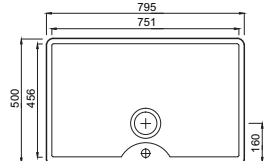

VINTAGE 600

The original weir overflow Belfast much loved by Traditionalists. This one uses the latest technology and is of hollow construction lessening weight and featuring sharper lines. Available in the traditional White and also in Anthracite for the kitchen that is slightly ahead of the rest.

Vintage 600 Single bowl

Ref. VIN600 White **£362**

Ref. VIN600AN Anthracite **£450**

Installation: Apron Front

Overall size: 595/455/250 mm

Bowl size: 534/393/214 mm

Overflow: Yes

Tap-holes: No

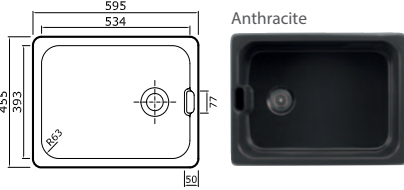

Anthracite

Vintage 600 Waste Options (85mm Flange)



60mm Waste Ref. WRPC
Stainless **£30**



60mm PVD Waste Ref. WRPAB
Artisan Brass **£47**



60mm PVD Waste Ref. WRPRC
Regency Copper **£47**



60mm PVD Waste Ref. W60G
Gold **£47**



Vintage 600 shown with Juno tap in Chrome - see page 228

Ceramic

VINTAGE 900

The **Vintage 900** has a classical origin but with elements of modernity expressed by the slender wall construction, this cleaner line look sets Vintage in both contemporary and traditional camps.

Vintage 900 Double bowl

Ref. VIN900 White **£544**

Standard Waste WKIT2 S/S £52

Installation: Apron Front

Overall size: 895/460/220 mm

Bowl size: 416/419/195 mm

Overflow: Yes

Tap-holes: No

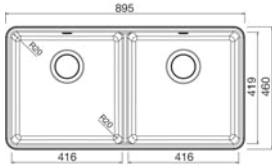

Vintage 900

Thomas Denby Wastes

Alternative PVD wastes also available see page 158



Chrome Ref. TD2WC **£113**



Bronze PVD Ref. TD2WBR **£190**



Brushed Steel Ref. TD2WBS **£129**



Regency Copper PVD Ref. TD2WRC **£190**



Polished Nickel PVD Ref. TD2WNI **£190**



Brushed Brass PVD Ref. TD2WBB **£190**



Vintage 900 shown with Siren Twist & Spray tap in Chrome - see page 220



Vintage 800 pictured with grids



VINTAGE 800

The **Vintage 800** has all the traditional benefits of the classic Farmhouse but with contemporary styling which include a distinctive triangular tap platform and crisp slim walling. Bottom basin grids available.

Vintage 800 Double bowl

Ref. VIN800 White £487

Standard Waste WKIT2 S/S £52

Installation: Apron Front
Overall size: 794/490/220 mm
Bowl size: 366/449/195 mm
Overflow: Yes
Tap-Holes: 1

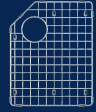

Vintage 800 Grids
Ref. Grid80R £56
Ref. Grid80L £56

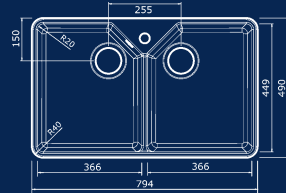

Thomas Denby Wastes

TD1W** = Single Bowl TD2W** = Double Bowl



Chrome
TD1WC £61
TD2WC £113



Bronze PVD
TD1WBR £106
TD2WBR £190



Brushed Steel
TD1WBS £68
TD2WBS £129



Regency Copper PVD
TD1WRC £106
TD2WRC £190



Polished Nickel PVD
TD1WNI £106
TD2WNI £190



Brushed Brass PVD
TD1WBB £106
TD2WBB £190

Alternative PVD wastes also available see page 158

VINTAGE 800S

The **Vintage 800S** is the single bowl version of the 800 useful when more space is required for cleaning those large pans, the finish has the same crisp slim walling.

Vintage 800S Single bowl

Ref. VIN800S White £487

Standard Waste WKIT1 S/S £28

Installation: Apron Front
Overall size: 795/460/220 mm
Bowl size: 735/400/195 mm
Overflow: Yes Tap-Holes: No

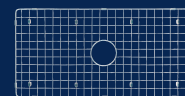
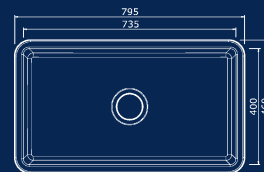

Vintage 800S Grid
Ref. GRID80S £88

HERITAGE

The **Heritage** Farmhouse sinks offer true centrepiece qualities with twin full size bowls which are ideal for performing different tasks simultaneously, such as washing up and food prep. These traditional designs have used a slimmer wall construction which has created a more contemporary aesthetic. Both models are supplied with a tap platform suitable for a Monobloc mixer tap, thus avoiding the need to drill out the work surface.

Thomas Denby Wastes 2 Alternative PVD wastes also available see page 158



Chrome
TD2WC £113



Bronze PVD
TD2WBR £190



Brushed Steel
TD2WBS £129



**Regency
Copper PVD**
TD2WRC £190



**Polished
Nickel PVD**
TD2WNI £190



**Brushed
Brass PVD**
TD2WBB £190

HERITAGE 800



Heritage 800

Double bowl with Tap Ledge

Ref. HER800 White **£530**

Standard Waste WKIT2 S/S £52

Installation: Apron Front

Overall: 795/500/220 mm

Bowl sizes: 364/456/198 mm

Overflow: No

Tap-Holes: 1 (available without tap hole by Special Order)

Weight: 45kg

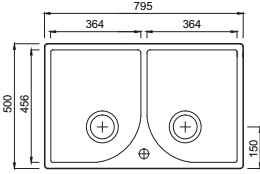

Heritage 800 shown with Alrisha tap in Chrome - see page 311

HERITAGE 900



Heritage 900

Double bowl with Tap Ledge

Ref. HER900 White **£630**

Standard Waste WKIT2 S/S £52

Installation: Apron Front

Overall: 895/550/220 mm

Bowl sizes: 414/505/198 mm

Overflow: No

Tap-Holes: 1 (available without tap hole by Special Order)

Weight: 53kg

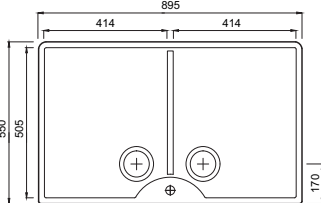



Ashton 60 shown with Titania Stainless Steel tap - see page 258

ASHTON 60

The **Ashton** is a classical Butler sink incorporating a tap ledge with three semi-prepared tap-hole positions, making it suitable for a variety of tap styles. A useful accessory ledge has been added to the bowl profile to support a range of accessories - we will be pleased to announce the launch of these very soon. This traditional fireclay sink has a usefully capacious bowl making it a great choice for a family kitchen and an ideal choice for the utility room.



Ashton 60
Single bowl with Tap Ledge
Ref. ASH60 White £390
Standard Waste WKIT1 S/S £28

Installation: Apron Front
Overall: 599/632/220 mm
Bowl sizes: 531/442 mm
Overflow: Yes
Tap-Holes: 1
Weight: 32.5kg

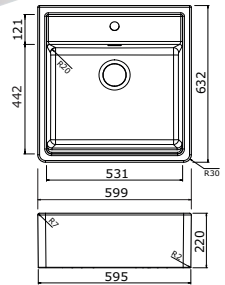

UTILITY SINKS

The **Utility** sinks are available in two sizes, big and very big! These versatile sinks are the ideal solution for the utility room with multi-function abilities from dyeing the curtains to washing the dog!



As Inset

Utility Large



As Lay-On

Utility Medium

Utility Medium
Ref. UT510 White £322
Standard Waste
WKIT1 S/S £28

Installation: Lay-On
Overall size: 510/506/235 mm
Bowl size: 449/357/210 mm
Tap-Holes: 1

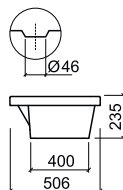
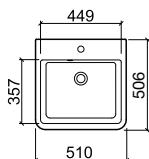

Utility Large
Ref. UT660 White £381
Standard Waste
WKIT1 S/S £28

Installation: Lay-On
Overall size: 660/506/236 mm
Bowl size: 599/357/210 mm
Tap-Holes: 1

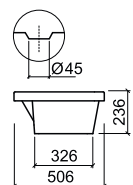
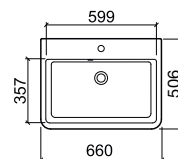

LAUNDRY SINKS



A pair of laundry sinks - perfect for when the duvet is just too big for the washing machine.

Laundry Small

Ref. CLS White £295

Installation: Inset
Overall size: 390/605/375 mm
Bowl size: 300/270/340 mm
Minimum cabinet size: Bespoke
Overflow: No

Waste: Clicker sprung plug
Ref. CW2010 Chrome £31

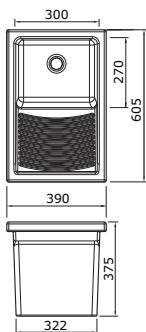

Laundry Large

Ref. CLL White £377

Installation: Inset
Overall size: 745/640/365 mm
Bowl size: 645/325/330 mm
Minimum cabinet size: Bespoke
Overflow: No

Waste: Clicker sprung plug
Ref. CW2010 Chrome £31

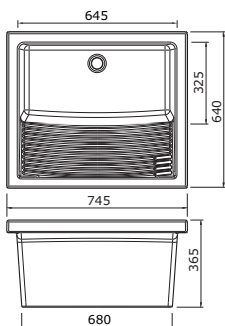

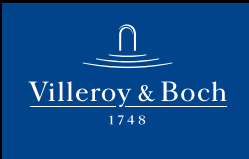

Ceramics from Villeroy & Boch combine the experience of traditional craftsmanship with maximum industrial precision. The result: products that enrich life with good design, lasting quality and with an assured sense of style. Kitchen sinks from Villeroy & Boch combine practicality and design with the tried-and-tested qualities of ceramics, which are offered by almost no other material.

Classicline Ceramicplus

** Add colour suffix when ordering

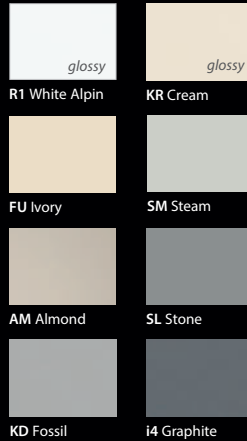

Premiumline Ceramicplus

** Add colour suffix when ordering



Trendline Ceramicplus

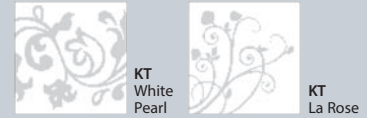

Siluet 60 pictured in Ebony

SILUET Ceramic Plus

The **Siluet's** newly developed high strength TitanCeram allows for the slenderest of sink profiles with precise edges and contours whilst retaining all of Villeroy & Boch's high quality ceramic credentials. The flowing, sensual design means the Siluet is particularly suited for modern and urban settings.



Siluet 45 Single bowl and drainer
Ref. 3334 00 R1 White Alpin **£795**
Ref. 3334 00 ** Classicline **£795**
Ref. 3334 00 ** Premiumline **£903**

Standard Waste Ref. VBW £30

Installation: Inset
 Sink Depth: 220 mm
 Cutout size: 760/470 mm
 Minimum cabinet size: 450 mm
 Overflow: Yes
 Tap-Holes: 1 reversible (pre-scored)

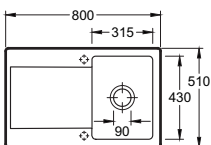

Siluet 50 Single bowl and drainer
Ref. 3335 00 R1 White Alpin **£814**
Ref. 3335 00 ** Classicline **£814**
Ref. 3335 00 ** Premiumline **£924**

Standard Waste Ref. VBW £30

Installation: Inset
 Sink Depth: 220 mm
 Cutout size: 860/470 mm
 Minimum cabinet size: 500 mm
 Overflow: Yes
 Tap-Holes: 1 reversible (pre-scored)

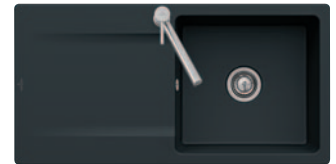
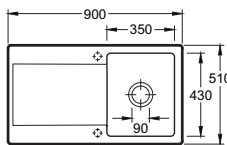

Siluet 60 Single bowl and drainer
Ref. 3336 00 R1 White Alpin **£914**
Ref. 3336 00 ** Classicline **£914**
Ref. 3336 00 ** Premiumline **£1041**

Standard Waste Ref. VBW £30

Installation: Inset
 Sink Depth: 220 mm
 Cutout size: 960/470 mm
 Minimum cabinet size: 600 mm
 Overflow: Yes
 Tap-Holes: 1 reversible (pre-scored)

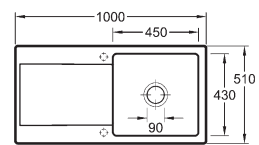



Siluet 50S Single bowl
Ref. 3345 00 R1 White Alpin **£653**
Ref. 3345 00 ** Classicline **£653**
Ref. 3345 00 ** Premiumline **£798**
Standard Waste Ref. VBW £30

Installation: Inset
 Sink Depth: 220 mm
 Cutout size: 480/480 mm
 Minimum cabinet size: 500 mm
 Tap-Holes: 2 (pre-scored)

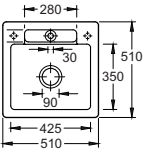

Siluet 60S Single bowl
Ref. 3346 00 R1 White Alpin **£704**
Ref. 3346 00 ** Classicline **£704**
Ref. 3346 00 ** Premiumline **£740**
Standard Waste Ref. VBW £30

Installation: Inset
 Sink Depth: 220 mm
 Cutout size: 570/480 mm
 Minimum cabinet size: 600 mm
 Tap-Holes: 2 (pre-scored)

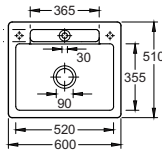

Siluet 50S pictured in Stone



Siluet 60R pictured in White Alpin

SILUET COLOURS

Classicline
 KR, KD, i4, FU,
 SM, SL, AM

Premiumline
 JO, S5, TR, KG

R1 White Alpin is standard delivery

 Add colour suffix when ordering - Allow 4 weeks delivery.



Siluet 60R 1.5 bowl and drainer
Ref. 3337 00 R1 White Alpin **£922**
Ref. 3337 00 ** Classicline **£922**
Ref. 3337 00 ** Premiumline **£1050**
Standard Waste Ref. VB2W £57

Installation: Inset
 Sink Depth: 220 mm
 Cutout size: 960/470 mm
 Minimum cabinet size: 600 mm
 Overflow: No
 Tap-Holes: 1 reversible (pre-scored)

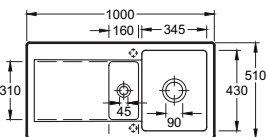

Ref. 9K12 00 K1
 S/S Basket **£247**
 (for use with Siluet 45)

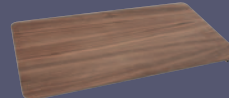

Ref. 8K36 10 00
 Walnut Chopping Board **£221**
 (for use with Siluet 45, 50, 60 & 60R)



Ref. 9K10 00 K1
 S/S Basket **£274**
 (for use with Siluet 60)

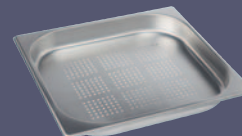

Ref. 8299 05 K1
 S/S Steamer Container **£85**
 (for use with Siluet 60)



Ref. 9K11 00 K1
 S/S Basket **£262**
 (for use with Siluet 50 & 60R)



Ref. 8299 06 K1
 S/S Steamer Container **£58**
 (for use with Siluet 60R)

Tap Holes

Chargeable knock-out service available on request

SUBWAY



The **Subway** are a range of minimalist modern design sinks that transform ceramic from the traditional into the contemporary. It is a versatile family of bowl only sinks and seven very chic drainer models.

Subway sinks are available in all colours.

** Add colour suffix when ordering and allow 4 weeks delivery for colours.

SUBWAY BASKETS

- 60XL Ref. 8K31 00 K1 £132
- 60XR Ref. 8K05 00 K1 £132
- 60 Ref. 8K04 00 K1 £132
- 45 Ref. 8K06 00 K1 £132
- 50 Ref. 8K05 00 K1 £132
- 80 Ref. 8K07 00 K1 £132



Subway 60XL pictured in White Alpin



Fossil



White Alpin

Subway 60 1.5 bowl & drainer - Ceramic Plus

Left Hand Drainer

Ref. 6712 00 R1 White Alpin £892

Ref. 6712 00 ** Classicline £892

Ref. 6712 00 ** Premiumline £1017

Standard Waste Ref. VB2W £57

includes Plumbing Kit

Installation: Inset

Bowl depth: 220 mm

Cutout size: 970/480 mm

Minimum cabinet size: 600 mm

Tap-Holes: 1

Right Hand Drainer

Ref. 6770 00 R1 White Alpin £892

Ref. 6770 00 ** Classicline £892

Ref. 6770 00 ** Premiumline £1017

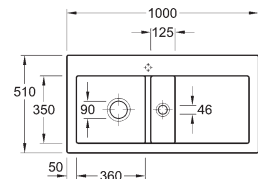



Subway 80 pictured in Ebony

ROLL-UP RACK

Ref. 9K08 00 K1 Universal Roll-up Rack £145
Dimensions: 445/450 mm

Subway 45 Single bowl & drainer - Ceramic Plus

Left Hand Drainer

Ref. 6714 0F White Alpin £735

Ref. 6714 0F ** Classicline £735

Ref. 6714 0F ** Premiumline £833

Right Hand Drainer

Ref. 6772 0F White Alpin £735

Ref. 6772 0F ** Classicline £735

Ref. 6772 0F ** Premiumline £833

Standard Waste Ref. VBW £30

Installation: Flush Fit

Bowl depth: 220 mm

Cutout size: Available on request

Minimum cabinet size: 450 mm

Tap-Holes: 1

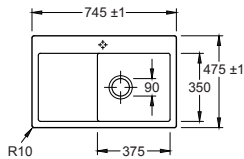

Subway 80 1.5 bowl and drainer Ceramic Plus

Ref. 6726 00 White Alpin £995

Standard Waste Ref. VB2W £57

includes Plumbing Kit

Installation: Inset

Bowl depths: 190 mm & 220 mm

Cutout size: 1130/480 mm

Minimum cabinet size: 800 mm

Tap-Holes: 1 reversible (pre-scored)

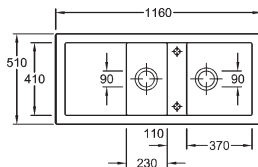

**
Add colour suffix
when ordering and
please allow 4
weeks delivery for
coloured sinks

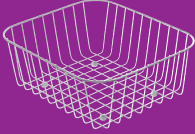

SUBWAY BASKETS

50 S Ref. 8K31 00 K1 £132

60 S Ref. 8431 00 K1 £132



Subway 45 Compact pictured in White Alpin



Subway 45 Compact Single bowl - Ceramic Plus

Left Hand Drainer (includes Roll-up Rack)

Ref. 3313 00 R1 White Alpin £639

Ref. 3313 00 ** Classicline £639

Ref. 3313 00 ** Premiumline £724

Standard Waste Ref. VBW £30

Installation: Inset
Bowl depth: 220 mm
Cutout size: 590/480 mm
Minimum cabinet size: 450 mm
Tap-Holes: 1

Right Hand Drainer (includes Roll-up Rack)

Ref. 3312 00 R1 White Alpin £639

Ref. 3312 00 ** Classicline £639

Ref. 3312 00 ** Premiumline £724

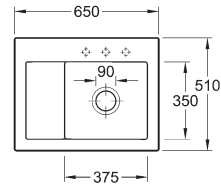

Subway 60 XM pictured in White Alpin



Subway 60 XM 1.5 bowl - Ceramic Plus

Ref. 6780 00 R1 White Alpin £702

Ref. 6780 00 ** Classicline £702

Ref. 6780 00 ** Premiumline £796

Standard Waste Ref. VB2W £57

includes Plumbing Kit

Installation: Inset
Bowl depth: 225 mm
Cutout size: 590/480 mm
Minimum cabinet size: 600 mm
Tap-Holes: 1

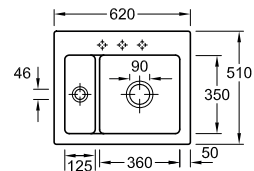

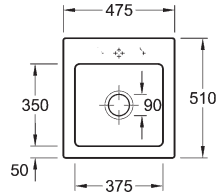

Subway 45 XS Single bowl - Ceramic Plus

Ref. 6781 00 R1 White Alpin **£639**

Ref. 6781 00 ** Classicline **£639**

Ref. 6781 00 ** Premiumline **£724**

Standard Waste Ref. VBW £30

Installation: Inset

Bowl depth: 225 mm

Cutout size: 445/480 mm

Minimum cabinet size: 450 mm

Tap-Holes: 1



Subway 45 XS
pictured in Fossil

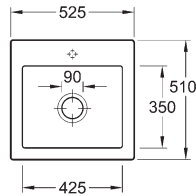

Subway 50 S Single bowl - Ceramic Plus

Ref. 3315 00 R1 White Alpin **£563**

Ref. 3315 00 ** Classicline **£563**

Ref. 3315 00 ** Premiumline **£636**

Standard Waste Ref. VBW £30

Installation: Inset

Bowl depth: 220 mm

Cutout size: 495/480 mm

Minimum cabinet size: 500 mm

Tap-Holes: 1



Subway 50 S pictured in Timber

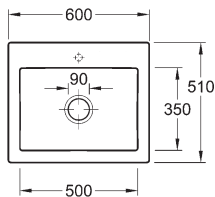

Subway 60 S Single bowl - Ceramic Plus

Ref. 3309 00 R1 White Alpin **£622**

Ref. 3309 00 ** Classicline **£622**

Ref. 3309 00 ** Premiumline **£707**

Standard Waste Ref. VBW £30

Installation: Inset

Bowl depth: 220 mm

Cutout size: 570/480 mm

Minimum cabinet size: 600 mm

Tap-Holes: 1



Subway 60 S pictured in White Alpin

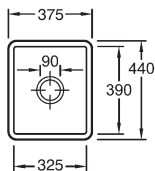

Subway 45 SU Single bowl - Ceramic Plus

Ref. 3324 00 R1 White Alpin **£509**

Ref. 3324 00 ** Classicline **£509**

Ref. 3324 00 ** Premiumline **£576**

Standard Waste Ref. VBW £30

Installation: Undermount
Bowl depth: 213 mm
Cutout size: 308/374 mm R10
Minimum cabinet size: 450 mm
Tap-Holes: No



Subway 60 XU pictured in White Alpin

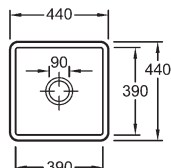

Subway 50 SU Single bowl - Ceramic Plus

Ref. 3325 00 R1 White Alpin **£560**

Ref. 3325 00 ** Classicline **£560**

Ref. 3325 00 ** Premiumline **£634**

Standard Waste Ref. VBW £30

Installation: Undermount
Bowl depth: 214 mm
Cutout size: 374/374 mm R10
Minimum cabinet size: 500 mm
Tap-Holes: No

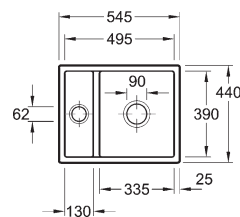

Subway 60 XU 1.5 bowl - Ceramic Plus

Ref. 6758 00 R1 White Alpin **£678**

Ref. 6758 00 ** Classicline **£678**

Ref. 6758 00 ** Premiumline **£769**

Standard Waste Ref. VB2W £57

includes Plumbing Kit
Installation: Undermount
Bowl depth: 200 mm
Cutout size: 483/374 mm R10
Minimum cabinet size: 600 mm
Tap-Holes: No

SUBWAY BASKETS

Subway 45 SU
Ref. 9850 00 K1 £132

Subway 50 SU
Ref. 9849 00 K1 £132

Subway 60 XU
Ref. 9841 00 K1 £132

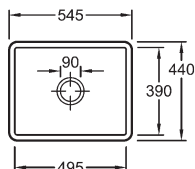

Subway 60 SU Single bowl - Ceramic Plus

Ref. 3310 00 R1 White Alpin **£655**

Ref. 3310 00 ** Classicline **£655**

Ref. 3310 00 ** Premiumline **£741**

Standard Waste Ref. VBW £30

Installation: Undermount
Bowl depth: 213 mm
Cutout size: 483/374 mm R10
Minimum cabinet size: 600 mm
Tap-Holes: No



Subway 60 SU pictured in White Alpin



Cisterna 60C
pictured in White Alpin



Cisterna 60B pictured in Graphite

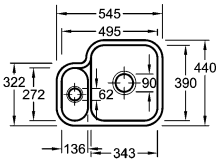

Cisterna 60B 1.5 bowl
Ref. 6702 00 White Alpin **£618**
Standard Waste Ref. VB2W £57
 includes Plumbing Kit
 Installation: Undermount
 Bowl depth: 200 mm
 Cutout size: See template R60.5
 Minimum cabinet size: 600 mm
 Tap-Holes: No

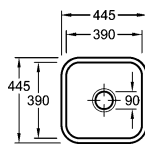

Cisterna 50 Single bowl
Ref. 6703 00 White Alpin **£593**
Ref. 6703 00 ** Classicline **£717**
Ref. 6703 00 ** Premiumline **£814**
Standard Waste Ref. VBW £30
 Installation: Undermount
 Bowl depth: 200 mm
 Cutout size: 376/376 mm R63
 Minimum cabinet size: 500 mm
 Tap-Holes: No

CISTERNA

The **Cisterna** are a traditional range of undermounted sinks with four separate size bowls to mix and match for the perfect combination, or choose the ever versatile 1.5 bowl model which is a most popular choice.

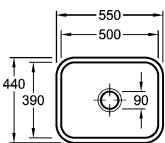

Cisterna 60C Single bowl
Ref. 6706 00 White Alpin **£658**
Ref. 6706 00 ** Classicline **£719**
Ref. 6706 00 ** Premiumline **£818**
Standard Waste Ref. VBW £30
 Installation: Undermount
 Bowl depth: 200 mm
 Cutout size: 482/376 mm R63
 Minimum cabinet size: 600 mm
 Tap-Holes: No

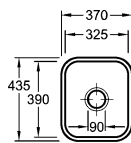

Cisterna 45 Single bowl
Ref. 6704 00 White Alpin **£598**
Ref. 6704 00 ** Classicline **£646**
Ref. 6704 00 ** Premiumline **£766**
Standard Waste Ref. VBW £30
 Installation: Undermount
 Bowl depth: 200 mm
 Cutout size: 310/376 mm R63
 Minimum cabinet size: 450 mm
 Tap-Holes: No



Cisterna 45 pictured in White Alpin

CISTERNA BASKETS

Cisterna 45
Ref. 9850 00 K1 £132

Cisterna 50
Ref. 9849 00 K1 £132

Cisterna 60C
Ref. 8397 00 K1 £132

Cisterna 60B
Ref. 9841 00 K1 £132



Architectura 60 XR pictured in Graphite



Architectura 60 pictured in White Alpin

ARCHITECTURA



Ceramic Plus

The **Architectura** is the latest V&B creation. These new additions to the range are an ideal choice in the kitchen for both contemporary or traditional settings, the unusual tapering four-flute draining channels create a very smart look indeed.

COLOURS

Classicline
KR, KD, i4, FU,
SM, SL, RW
Premiumline
JO, S5, TR



Architectura 50 Single bowl and drainer
Ref. 3350 00 R1 White Alpin **£610**
Ref. 3350 00 ** Classicline **£610**
Ref. 3350 00 ** Premiumline **£690**

Standard Waste Ref. VBW £30

Installation: Inset
Sink Depth: 220 mm
Cutout size: 825/470 mm
Minimum cabinet size: 500 mm
Tap-Holes: 1 reversible (pre-scored)

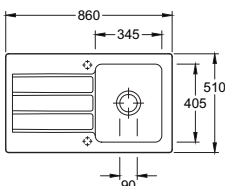

Architectura 60 Single bowl and drainer
Ref. 3360 00 R1 White Alpin **£751**
Ref. 3360 00 ** Classicline **£751**
Ref. 3360 00 ** Premiumline **£845**

Standard Waste Ref. VBW £30

Installation: Inset
Sink Depth: 220 mm
Cutout size: 970/470 mm
Minimum cabinet size: 600 mm
Tap-Holes: 1 reversible (pre-scored)

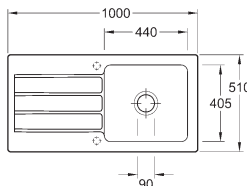

Architectura 60 XR 1.5 bowl and drainer
Ref. 3365 00 R1 White Alpin **£664**
Ref. 3365 00 ** Classicline **£664**
Ref. 3365 00 ** Premiumline **£753**

Standard Waste Ref. VB2W £57
includes Plumbing Kit

Installation: Inset
Bowl depth: 220 mm ½ Bowl depth: 155 mm
Cutout size: 970/470 mm
Minimum cabinet size: 600 mm
Tap-Holes: 1 reversible (pre-scored)

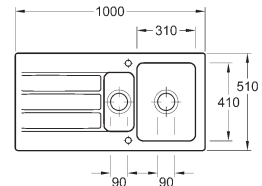



TIMELINE



Ceramic Plus

The **Timeline** is a very sophisticated sink with a minimalist flat drainer and sleek ultra slim profile that belies the normal chunky ceramic heritage.

Timeline 60 pictured in Ivory



Timeline 60 Single bowl and drainer
(includes Roll-up Rack)

Ref. 6790 00 R1 White Alpin **£921**

Ref. 6790 00 ** Classicline **£921**

Ref. 6790 00 ** Premiumline **£1041**

Standard Waste Ref. VBW £30

Installation: Inset

Bowl depth: 220 mm

Cutout size: 960/470 mm

Minimum cabinet size: 600 mm

Tap-Holes: 1 reversible (pre-scored)



Timeline 60 pictured in White Alpin



Roll-up Rack included

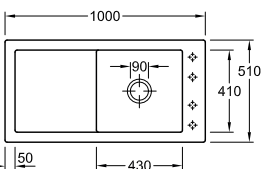

TIMELINE COLOURS

Classicline

RW, KR, FU, SM, KD, SL, I4

Premiumline

TR, S5, JO, KG

Add colour suffix when
ordering and please
allow 4 weeks delivery
for coloured sinks

BASKETS

Architectura 50

Ref. 9K09 00 K1 £132

Architectura 60

Ref. 8K12 00 K1 £132

Timeline 45 21

Ref. 8K13 00 K1 £132

Timeline 60

Ref. 8K12 00 K1 £132



MEDICI

The **Medici** will look at home in both farmhouse and urban type settings and is a most practical family of sinks. Both models have sensible size bowls and neat recessed draining grooves that offer a modern touch.

Medici Single bowl and drainer

Ref. 6771 White **£445**

Standard Waste Ref. VBW **£30**

Installation: Inset

Overall size: 920/510 mm

Bowl size: 395/380/210 mm

Cutout size: 870/480 mm

Minimum cabinet size: 500 mm

Tap-Holes: 1 reversible (pre-scored)

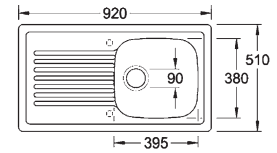

Medici 1.5 bowl and drainer

Ref. 6753 White **£493**

Standard Waste Ref. VB2W **£57**

includes Plumbing Kit

Installation: Inset

Overall size: 1000/510 mm

Bowl size: 345/395/210 mm

Half bowl: 150/260 mm

Cutout size: 970/480 mm

Minimum cabinet size: 600 mm

Tap-Holes: 1 reversible (pre-scored)

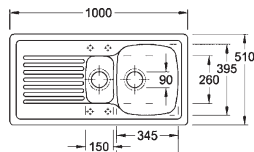

Optional Accessories



Ref. PCOL01
Plastic
Colander **£31**

Tap Holes

Chargeable knock-out service available on request



Flavia 50 pictured in Chromite (Glossy)



Flavia 60 pictured in White Alpin

FLAVIA



Ceramic Plus

The **Flavia's** timeless design combines sharp radius bowl corners and classic draining panels.

This combination has eminent suitability for both contemporary and traditional kitchens.



Flavia 50 Single bowl and drainer
Ref. 3305 00 R1 White Alpin **£711**
Ref. 3305 00 ** Classicline **£711**
Ref. 3305 00 ** Premiumline **£807**

Standard Waste Ref. VBW £30

Installation: Inset
 Sink Depth: 220 mm
 Cutout size: 870/480 mm
 Minimum cabinet size: 500 mm
 Overflow: Yes
 Tap-Holes: 1 reversible (pre-scored)

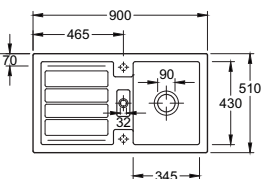

Flavia 60 Single bowl and drainer
Ref. 3304 00 R1 White Alpin **£895**
Ref. 3304 00 ** Classicline **£895**
Ref. 3304 00 ** Premiumline **£996**

Standard Waste Ref. VB2W £57
 includes Plumbing Ki

Installation: Inset
 Sink Depth: 220 mm
 Cutout size: 980/480 mm
 Minimum cabinet size: 600 mm
 Overflow: Yes
 Tap-Holes: 1 reversible (pre-scored)

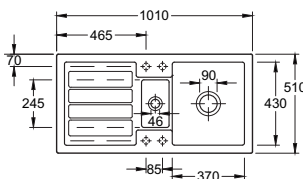

FLAVIA COLOURS

Classicline
 KR, KD, i4, FU, SM,
 SL, RW

Premiumline
 JO, S5, TR

**
 Add colour suffix
 when ordering
 and please allow 4
 weeks delivery for
 coloured sinks



BASKETS

Flavia 50
Ref. 8K11 00 K1 £132
 Flavia 60
Ref. 8K10 00 K1 £132



Provence Double Bowl shown with Elegance Twist & Spray tap in Chrome - see page 323



Elegance Twist & Spray tap in Brushed Nickel - see page 307

Provence Double bowl
and drainer

Ref. EV90002 White £545

Standard Waste Ref. VB2W £57
includes Plumbing Kit

Installation: Lay-On

Overall size: 1210/610 mm

Bowl Sizes: 385/420/170mm

Cabinet Size: 1200mm

Tap-Holes: 1 reversible(pre-scored)

Overflow: Yes

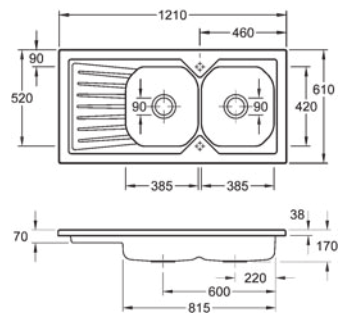



PROVENCE



The **Provence** sinks are the original lay-on design that graced the kitchens of old. They are making a come back as they are simply the most practical form of sink. They totally maximise the area for washing and provide a total wet-area for splashing about!

They will suit traditional kitchens best or make a brilliant choice for the utility sink.

Provence Single bowl and drainer

Ref. EV6738 White **£512**
Standard Waste Ref. VBW £30

Installation: Lay-On
Overall size: 1000/600 mm
Bowl Size: 475/395/220 mm
Cabinet Size: 1000 mm
Tap-Holes: 1 or 2 reversible (pre-scored)
Overflow: Yes

Tap Holes

Chargeable knock-out service available on request

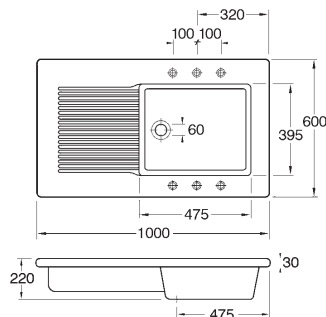



FARMHOUSE 60

This is a timeless classic but has been given a modern twist with finer lines that allow it to grace both traditional and contemporary kitchens.

Farmhouse 60 Single bowl
Ref. 6322 90 01 White **£427**
Standard Waste Ref. VBW £30
 Installation: Apron Front
 Overall size: 595/500 mm
 Bowl size: 555/430/180 mm
 Minimum cabinet size: 600 mm
 Tap-Holes: No
 Overflow: No

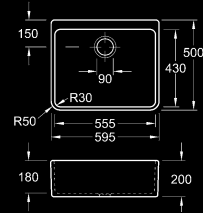

FARMHOUSE 80

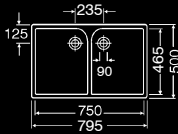

Farmhouse 80 Double bowl
Ref. 6331 90 01 White **£566**
Standard Waste Ref. VB2W £57
 includes Plumbing Kit
 Installation: Apron Front
 Overall size: 795/500/220 mm
 Minimum cabinet size: 800 mm
 Tap-Holes: 1 (pre-scored)
 Overflow: No



FARMHOUSE 90

Both models (80 & 90) offer a supreme capacity for cleaning and food preparation. The **Farmhouse 90** is particularly excellent in swallowing up the increasingly large oven trays.

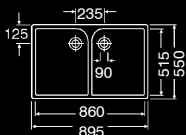

Farmhouse 90 Double bowl
Ref. 6332 90 01 White **£678**
Standard Waste Ref. VB2W £57
 includes Plumbing Kit
 Installation: Apron Front
 Overall size: 895/550/220 mm
 Minimum cabinet size: 900 mm
 Tap-Holes: 1 (pre-scored)
 Overflow: No



BUTLER 90

Ceramic Plus

The **Butler 90** combines huge practicality with it's generous multi-bowl system. The exuberant styling really sets this sink apart from its peers. The sink is supplied with 1 tap hole, which can be covered or used for soap dispenser/pop-up waste when using wall mounted taps.

Optional Accessories



Wire Basket (for 0,75 bowl)
Ref. 8341 00 K1 £130



Strainer Bowl (transparent)
Ref. 8323 00 K2 £42

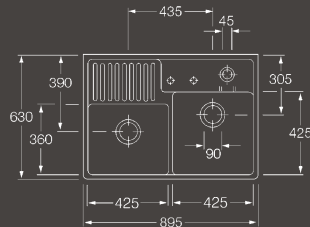

Butler 90 1.75 bowl

Ref. 6323 91 R1 White Alpin £930

Ref. 6323 00 KT White Pearl £1108

Standard Waste Ref. VB2W £57
includes Plumbing Kit

Installation: Apron Front
Overall size: 895/630/220 mm
Bowl size: 425/425/180 mm
Second bowl size: 425/360/180 mm
Minimum cabinet size: 900 mm
Tap-Holes: 1 (left) 1 (pre-scored, right)
Overflow: No

BUTLER 60

Ceramic Plus

The **Butler 60** has a useful rear ledge with three semi-prepared tap-hole positions, so a monobloc, Bridge mixer or 3-hole mixer can be used.

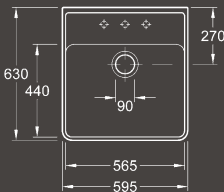

Butler 60 Single bowl with tap ledge

Ref. 6320 60 R1 White Alpin £576

Ref. 6320 00 KT White Pearl £691

Standard Waste Ref. VBW £30

Installation: Apron Front
Overall size: 595/630/220 mm
Bowl size: 565/440/180 mm
Minimum cabinet size: 600 mm
Tap-Holes: 3 (pre-scored)
Overflow: Yes



Butler 60 showing the White Pearl design

ACCESSORIES

Every good kitchen needs the right material. Kitchen accessories must be of excellent quality if they are to meet the needs of everyday life.

Villeroy & Boch sets great store by intelligent details: complement your sink with accessories such as baskets (see sink pages) strainer bowls, waste bowls or cutting boards.



Universal Cutting Board - Beech

Ref. 8K00 10 00 £129

Fits the following sinks -

Flavia 45, 50 & 60

Siluet 45, 50 & 60

Subway 60XL, 60XR, 60XM, 60S, 60, 50S, 50, 45 Compact, 45XS,

45 Flat & 80

Architectura 50, 60 & 60XR

Timeline 45 & 60



Cutting Board - Walnut

Ref. 8K33 10 00 £186

Fits the following sinks -

Subway 60XL, 60XR, 60XM, 60S, 60, 50S, 50, 45 Compact, 45XS & 45 Flat



Universal Roll-up Rack

Ref. 9K08 00 K1 £145

Dimensions: 445/450 mm



Inset Strainer - Stainless Steel

Ref. 9K04 00 K1 £145

Fits the following sinks -

Subway 60XL, 60XR,

60XM, 60S, 60, 50S, 50,

45 Compact, 45XS & 45 Flat



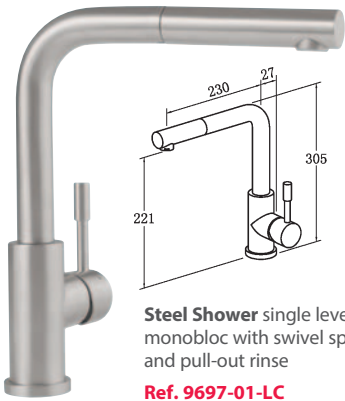

Steel Shower single lever monobloc with swivel spout and pull-out rinse

Ref. 9697-01-LC
Stainless Steel **£725**

MP Min 0.8 bar pressure required
360° swivel spout
Pull-out hose length 70cm
Mounting hole size Ø 35mm

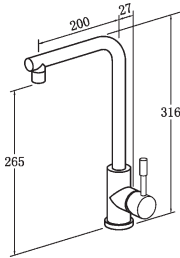

Modern Steel single lever monobloc with swivel spout

Ref. 9668-01-LC
Stainless Steel **£640**
Ref. 9668-01-LE
Polished Steel **£640**

MP Min 0.8 bar pressure required
360° swivel spout
Mounting hole size Ø 35mm



Como single lever monobloc with swivel spout

Ref. 9251-00-LC
Stainless Steel **£420**

Ref. 9251-00-LE
Polished Steel **£420**

MP Min 0.8 bar pressure required
360° swivel spout
Mounting hole size Ø 35mm

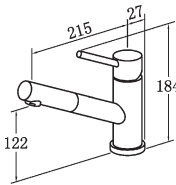

Como Shower single lever monobloc with swivel spout and pull-out rinse

Ref. 9252-00-LC
Stainless Steel **£561**

Ref. 9252-00-LE
Polished Steel **£561**

MP Min 0.8 bar pressure required
360° swivel spout
Pull-out hose length 70cm
Mounting hole size Ø 35mm



Umbrella single lever monobloc with swivel spout

Ref. 9253-00-LC
Stainless Steel **£535**

Ref. 9253-00-LE
Polished Steel **£535**

MP Min 0.8 bar pressure required
360° swivel spout
Mounting hole size Ø 35mm

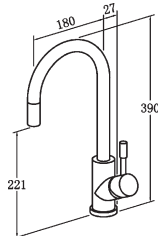

Umbrella Flex single lever monobloc with swivel spout and pull-out rinse

Ref. 9254-00-LC
Stainless Steel **£644**

Ref. 9254-00-LE
Polished Steel **£644**

MP Min 0.8 bar pressure required
360° swivel spout
Pull-out hose length 70cm
Mounting hole size Ø 35mm





"Handmade in England for over 100 years" isn't a label that can be copied or delivered easily. Nor is it one that Shaws take lightly.

England is famous for its quality manufacturing and Shaws are proud to uphold this tradition through their unique methods and their Master Craftsman, who undertake a ten year graduation.

Their professional artisans are carefully selected, exhaustively trained and continually developed to ensure that the standards never slip which why they can offer a lifetime warranty on all their sinks.

www.shawsofdarwen.com

CLASSIC BELFAST

Our traditional **Belfast** is produced from the classic original Victorian design and employs the unique weir style overflow.

Classic Belfast

Ref. **SCBE600** White **£481**

Installation: Apron Front
Overall: 595/460/255 mm
Bowl size: 540/380/220 mm
Overflow: Yes (Weir)

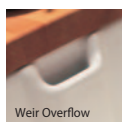
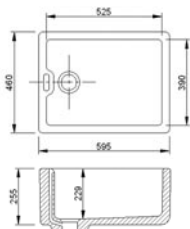

60mm Slotted Waste Option
with Plug & Chain
Ref. **WBESC**
S/S **£30**



Ref. **WRPC**
60mm Basket Strainer Waste
S/S **£30**



CLASSIC DOUBLE

A contemporary apron front double bowl with generous bowl dimensions.

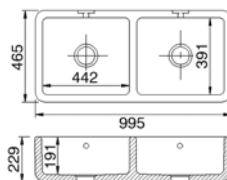

Classic Double 1000

Double bowl
Ref. **SCLD101** White **£976**
Standard Waste
Ref. **WKIT2** S/S **£52**
Installation: Apron Front
Overall size: 995/465/229 mm
Bowl sizes: 442/391/191 mm
Cabinet size: 1000 mm
Overflow: Yes

Classic Double 800

Double bowl
Ref. **SCLD800** White **£892**
Standard Waste
Ref. **WKIT2** S/S **£52**
Installation: Apron Front
Overall size: 795/465/229 mm
Bowl sizes: 342/391/191 mm
Cabinet size: 800 mm
Overflow: Yes



Shaws Wastes

- FT2900013 Chrome **£86 each**
- FT2900029 Nickel **£141 each**
- FT2900030 Gold **£141 each**
- FT2900028 Antique Bronze **£141 each**

CLASSIC



A versatile collection of traditional sinks from Shaws. All models can be installed as Undermounts or Insets.



Shaws Wastes
 Chrome **£86 each**
 Nickel **£141 each**
 Gold **£141 each**
 Antique Bronze **£141 each**



Classic Round
Ref. SCR0460 White **£425**
Standard Waste
Ref. WKIT1 S/S £28

Installation: Undermount or Inset
 Overall size: 460/191 mm
 Bowl size: 382/166 mm
 Minimum cabinet size: 500 mm
 With overflow



Classic Inset
Ref. SCIN760 White **£646**
Standard Waste Ref. WKIT1 S/S £28

Installation: Undermount or Inset
 Overall size: 760/460/265 mm Bowl size: 690/390/235 mm
 Minimum cabinet size: 800 mm
 With overflow



Original Belthorn
Ref. SBEL381 White **£411**
Standard Waste
Ref. WKIT1 S/S £28

Installation: Undermount or Inset
 Overall size: 381/381/191 mm
 Bowl size: 300/300/166 mm
 Minimum cabinet size: 400 mm
 Without overflow



Classic Inset
Ref. SCIN595 White **£551**
Standard Waste Ref. WKIT1 S/S £28

Installation: Undermount or Inset
 Overall size: 595/460/255 mm
 Bowl size: 525/390/227 mm
 Minimum cabinet size: 600 mm
 With overflow



Classic Square
Ref. SCSQ460 White **£425**
Standard Waste
Ref. WKIT1 S/S £28

Installation: Undermount or Inset
 Overall size: 460/460/191 mm
 Bowl size: 379/379/166 mm
 Minimum cabinet size: 500 mm
 With overflow



Classic Brindle
Ref. SCBH595WH White **£481**
Left hand main bowl only
Standard Waste Ref. WKIT2 S/S £52

Installation: Undermount or Inset
 Overall size: 548/500/199 mm
 Bowl size: 303/430/166 mm
 Half bowl size: 149/330/166 mm
 Minimum cabinet size: 600 mm
 With overflow



Classic Brindle 800
Ref. SCBH760WH White **£633** *Left hand main bowl only*
Standard Waste Ref. WKIT2 S/S £52

Installation: Undermount or Inset
 Overall size: 750/500/225 mm
 Bowl size: 420/410/195 mm Half bowl size: 209/310/195 mm
 Minimum cabinet size: 1000 mm
 With overflow



Bradshaw
Ref. SCBR900WH White **£1233** *Low-divide wall*
Standard Waste Ref. WKIT2 S/S £52

Installation: Undermount or Inset
 Overall size: 838/476/244 mm
 Bowl size: 506/405/224 mm Half bowl size: 226/405/224 mm
 Minimum cabinet size: 1000 mm
 With overflow

CLASSIC WATERSIDE

The **Waterside** includes a graceful bow front for a more elegant appearance.

Waterside 600

Ref. **SCWT595** White £696

Standard Waste

Ref. **WKIT1** S/S £28

Installation: Apron Front
Overall: 597/531/220 mm
Bowl depth: 190 mm
Overflow: Yes

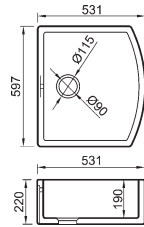

Shaws Wastes

- Chrome £86 each
- Nickel £141 each
- Gold £141 each
- Antique Bronze £141 each



CLASSIC BUTLER

The **Butler** sinks are beautifully crafted and ideal if you are looking for both a traditional or modern elegant look.

Butler 600

Ref. **SCBU600** White £595

Standard Waste

Ref. **WKIT1** S/S £28

Installation: Apron Front
Overall: 595/460/255 mm
Bowl size: 525/390/220 mm
Overflow: Yes

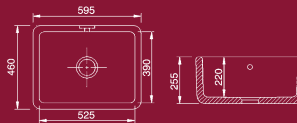

Butler 800

Ref. **SCBU800** White £736

Standard Waste Ref. **WKIT1** S/S £28

Installation: Apron Front
Overall: 795/460/255 mm
Bowl size: 725/390/220 mm
Overflow: Yes

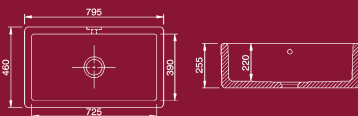

Butler 1000

Ref. **SCBU101** White £872

Standard Waste

Ref. **WKIT1** S/S £28

Installation: Apron Front
Overall: 914/460/255 mm
Bowl size: 844/390/220 mm
Overflow: Yes



CLASSIC SHAKER



Clean contemporary styling and traditional handcrafted methods are brought together in the **Shaker** range of sinks.

The Shaker 800 has a bowl deep enough for the largest of dishes.

Shaws Wastes

- Chrome **£86** each
- Nickel **£141** each
- Gold **£141** each
- Antique Bronze **£141** each



Shaker 800
Ref. SCSH108 White **£777**
Standard Waste
Ref. WKIT1 S/S £28

Installation: Apron Front
 Overall: 762/457/284 mm
 Bowl depth: 254 mm
 Overflow: Yes

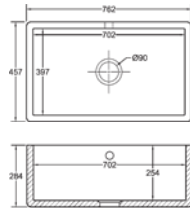

Shaker 900
Ref. SCSH900 White **£920**
Standard Waste
Ref. WKIT2 S/S £52

Installation: Apron Front
 Overall: 895/465/229 mm
 Bowl depth: 159 mm
 Overflow: Yes

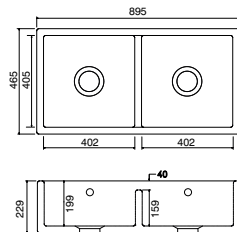

Shaker 1000
Ref. SCSH101 White **£976**
Standard Waste
Ref. WKIT2 S/S £52

Installation: Apron Front
 Overall: 995/465/229 mm
 Bowl depth: 159 mm
 Overflow: Yes

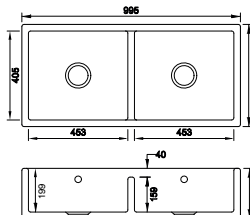



BOWLAND

The **Bowland's** classic fluted front sets it apart from its peers and the generously proportioned bowl will allow for all manner of tasks to be performed.

Bowland 800
Ref. BLF5312 White £1401
Standard Waste
Ref. WKIT1 S/S £28

Installation: Apron Front
 Overall size: 797/535/220 mm
 Bowl depth: 183 mm
 Overflow: Yes (3 hole)

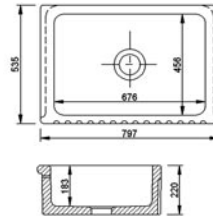

Bowland 600
Ref. SO600010 White £836
Standard Waste
Ref. WKIT1 S/S £28

Installation: Apron Front
 Overall size: 595/465/220 mm
 Bowl depth: 183 mm
 Overflow: Yes (3 hole)

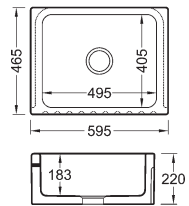

Shaws Wastes
 Chrome £86 each
 Nickel £141 each
 Gold £141 each
 Antique Bronze £141 each



RIBCHESTER

The **Ribchester** is perfect if you want a stylish fluted front combined with the convenience of double bowls.

Ribchester 800
Ref. SO0800010
 White £976
Standard Waste
Ref. WKIT2 S/S £52

Installation: Apron Front
 Overall size: 795/465/234 mm
 Overflow: Yes
 (3 hole in both bowls)

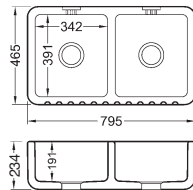

Shaws Wastes
 Chrome £86 each
 Nickel £141 each
 Gold £141 each
 Antique Bronze £141 each



EDGWORTH

Edgworth Offset Double Bowl

Ref. **SEDG100** White £1373

Standard Waste Ref. **WKIT2** S/S £52

Installation: Apron Front

Overall size: 997/470/255 mm

Bowl depth: 219 mm

Overflow: No

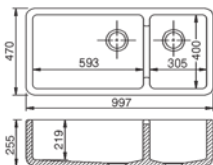

Shaws Wastes

Chrome £86 each

Nickel £141 each

Gold £141 each

Antique Bronze

£141 each



ENTWISTLE

Entwistle Large Single Bowl

Ref. **SOEN800** White £914

Standard Waste Ref. **WKIT1** S/S £28

Installation: Apron Front

Overall size: 760/460/255 mm

Bowl depth: 220 mm

Overflow: Yes (3 hole)

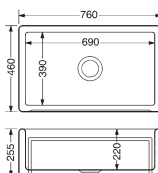

Ref. **FT0100010** £211

Butler 800, Entwistle,
Bowland 800 &
Shaker 800

Ref. **FT0300010** £197
Butler 600, Bowland 600
& Classic Inset 595

Ref. **FT0400010** £134
Ribchester 800 & 1000,
Classic Double 800 &
1000, Shaker 900 & 1000

Ref. **FT0500010** £211
Edgworth & Egerton
(small bowls only)

Ref. **FT0600010** £211
Edgworth & Egerton
(main bowls only)

Ref. **FT0700010** £211
Waterside 600



CLEANERS' SINK

Strictly for the garage or for those of you with a janitor. A practical cleaners' sink with a hinged bucket stand.

Ref. **BI465**

Cleaners' Sink

White £564

Installation: Wall Mounted

Overall size: 460/380/205 mm

Overflow: No

Support Brackets
& Stainless Steel Legs

Ref. **FT0100001** £82

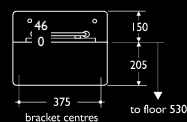
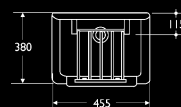

60mm Basket
Strainer Waste
S/S £30

CAST IRON SINKS

The gorgeous hues of enamelled Cast Iron let you bring your personality into your kitchen decor. Its rich finish and long-lasting presence make a bold statement in your kitchen.

Enamelled Cast Iron sinks are built with lasting beauty and the strength to withstand the test of time. The **Saxon** collection are crafted from at least 80% recycled material, and they come with a lifetime warranty. The manufacturing process ensures that each piece is a genuine, handcrafted original.

Cast Iron is simply the best medium for sinks because of its extreme durability, its high gloss surface maintains a rich finish that resists chipping, staining and denting and its sheer strength enables the creation of beautiful shapes and graceful lines. The authenticity of Cast Iron will complement other traditional kitchen features such as your range cooker.

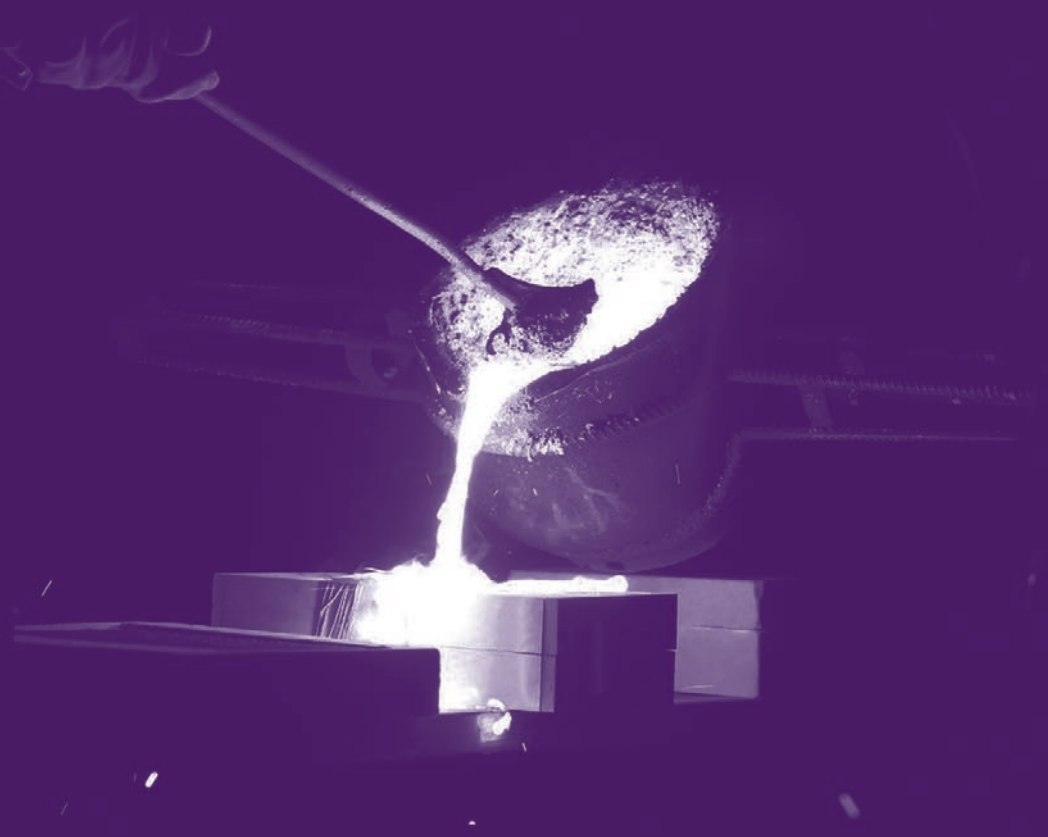



CLEARWATER
CAST IRON SINKS
HAVE A LIFETIME
WARRANTY

Cast Iron

SAXON COLLECTION

The **Saxon** collection are a family of two sinks with different bowl configurations that will meet the demands of most households. All share the ability to be installed as insets or undermounts. The high gloss lustre of the sinks set them apart from other sinks and their enduring properties that will ensure long lasting fabulous looks.

KEY FEATURES

- Lifetime warranty
- Luxurious high gloss surface
- Anti-bacterial highly durable surface
- Resistant to chipping, staining and denting
- Hand crafted original pieces
- Suitable for Kettle taps up to 98°C



Inset



Undermount

ICONS EXPLAINED

Installation



Inset (Flat)



Undermount

Other Details



Suitable for Kettle taps up to 98°C

PRODUCT BENEFITS

Heat Resistant: Cast Iron is highly heat resistant, so much so that hot pans straight from the stove can rest safely on the sink - a highly useful thing when juggling the pasta.

Hygienic: Totally non-porous, the ultra smooth surface is the most hygienic material for sinks and the easiest to keep clean.

Chemical Resistant: Resistant to all household chemicals including neat bleach.

Extreme Hardness: Extremely resistant to impact, the surface is so hard cutlery won't scratch the glazed surface through normal use.



Dirt-repellent effect



Odour-free



Heat-resistant 180°C



Food-safe



Hygienic Surface



Made to last



Stain-resistant



Impact-resistant



**Clearwater
Cast Iron and
Ceramic Cleaner**
Ref. CLEC200 £14

Removes stubborn metal marks and stains with little effort



Icons Explained
see page 29.

SAXON 560



The **Saxon 560** is a generous size single bowl that will tackle the big and smaller tasks with style. This classy sink exudes quality with its incredibly hardwearing lustrous surface that will set it apart from lesser material sinks. The 560 can be fitted as an inset or an undermount, so there are no excuses not to have one.



Saxon Single bowl
Ref. SAX C560 White £679
 Installation: Inset/Undermount
 Overall size: 560/460/240 mm
 Bowl size: 490/390/210 mm
 Minimum cabinet size: 600 mm
 Overflow: No
 Tap-holes: No

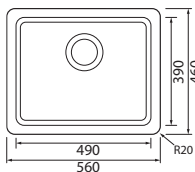

Standard Wastes



Stainless
W90C £24

Optional Coloured Wastes



Artisan Brass
W90AB £53



Regency Copper
W90RC £53



Gold
W90G £53



Matt Black
W90MB £53

1.0 Bowl = 1 x W90** 2.0 Bowl = 2 x W90**



Davina Twist & Spray tap in Chrome - see page 226



Saxon 200 shown with Elegance Bridge Twist & Spray tap in Brushed Bronze - see page 307



SAXON 200



The **Saxon 200** makes a wonderful centre piece in the kitchen with its magisterial good looks. This versatile sink boasts two equal bowls of a good size and are an ideal choice for the serious cook allowing space for food prep and clearing up simultaneously.

Chrome & Coloured Wastes available
see page 94 opposite for details



Saxon Double bowl
Ref. SAX C200 White £849
Installation: Inset/Undermount
Overall size: 840/460/240 mm
Bowl sizes: 367.5/390/210 mm
Minimum cabinet size: 900 mm
Overflow: No
Tap-holes: No

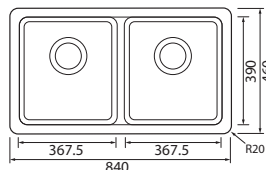

STAINLESS STEEL



Inset

This installation requires the sink to be mounted into the worktop from the above. This installation type is suitable for all types of worktop including laminated chipboard.

Page 98-122

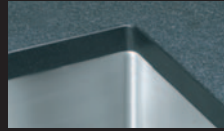

Undermount

This installation requires the sink to be fitted to the worktop from the underside. This installation type is only suitable for solid surface worktops such as Granite, Marble or Wood.

Page 124 -145



Apron Front

In this installation the sink is fitted directly onto a cabinet with its front fascia exposed. This type of installation is only suitable for solid surface worktops such as Granite, Marble or Wood.

Page 146 -149



Lay-On

Fit directly on to the kitchen cabinet and are not set into a work-top, therefore maximising the wet area. Each sink is supplied with twin tap-holes for either traditional pillar taps or deck mixer style taps.

Page 123



ICONS EXPLAINED

Installation



Inset (Flat)



Inset (Sloping)



Inset (Square)



Undermount



Flushmount



Butler



Lay-On

Handing



Left & Right Versions



Reversible

Other Details



Steel Gauge



Waste Included



Pop-Up Waste Included

PRODUCT BENEFITS

Stainless Steel remains the most popular medium for kitchen sink production. It's not difficult to realise when you consider it's main attributes:

Heat Resistant

Stainless Steel is highly heat resistant, so much so that hot pans straight from the stove can rest safely on the sink - a highly useful thing when juggling the pasta.

Hygienic

A totally non-porous surface that is easy to keep clean and consequently more hygienic.

Impact Resistant

Stainless Steel is the most forgiving material for impact and is the least likely material to damage your best china or glassware whilst remaining unscathed itself.



Dirt-repellent effect



Odour-free



Heat-resistant 180°C



Food-safe



Hygienic Surface



Made to last



Stain-resistant



Impact-resistant

INSET

The Clearwater Stainless Steel Inset collection is defined in four categories as listed below. The design choice is wide and varied and will suit all budgets and kitchen parameters. All products are produced in 304 grade steel and excellent quality has been maintained throughout this diverse range.



Stainless Steel

ICONS EXPLAINED

SilentCote®



SilentCote Treated

Sinks bearing the SilentCote icon are treated with a sound absorbing thermal paint on the underside, reducing noise and increasing durability.

Pre-fitted Seal



Seal Fitted

Sinks bearing this icon come with a seal already applied to the sink so that the installer does not have to do it by hand.

Sink Finish



Brushed, Silk or Satin



Studio Sinks Page 98-111



Designer Sinks Page 112-119



Bar Sinks Page 120-121



Contract Sinks Page 122-123

Finishes



Brushed Finish
distinctive grained finish that is ideal for matching with stainless steel appliances.

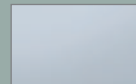

Satin Finish
even soft silk finish.

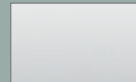

Silk Finish
lightly brushed with a brighter tone.



Verdi VE96 shown with Magus 3 Kettle tap in Chrome - see page 176

VERDI



The **Verdi** is our latest economically priced range of sinks offering modern design and assured quality at a great price. Choose from three models; two single bowls one of which has a capacious washing bowl (see illustration) making it an ideal choice for cleaning big pots and oven trays. Then there is of course the ever versatile 1.5 bowl model which still remains the most popular model in the UK.

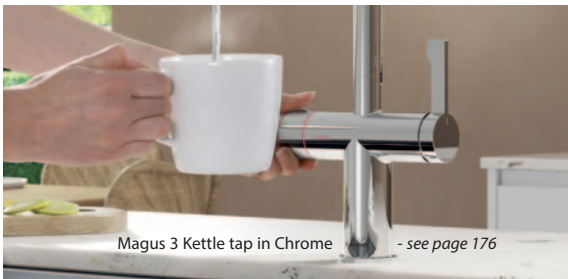

Magus 3 Kettle tap in Chrome - see page 176



Verdi Single bowl and drainer

Ref. VE80 £115

Overall size: 800/500 mm
 Bowl size: 340/400/170 mm
 Cutout size: 780/480 mm
 Minimum cabinet size: 450 mm
 Waste included: 90 mm BSW



Verdi Large bowl and drainer

Ref. VE96 £135

Overall size: 965/500 mm
 Bowl size: 400/400/170 mm
 Cutout size: 945/480 mm
 Minimum cabinet size: 600 mm
 Waste included: 90 mm BSW

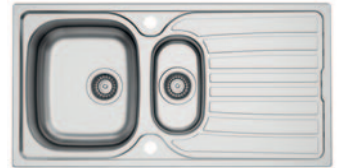

Verdi 1.5 bowl and drainer

Ref. VE150 £145

Overall size: 965/500 mm
 Bowl size: 340/400/170 mm
 Half bowl: 160/300/101 mm
 Cutout size: 945/480 mm
 Minimum cabinet size: 600 mm
 Waste included: 2 x 90 mm BSW & Plumbing Kit

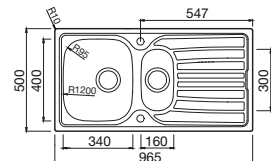
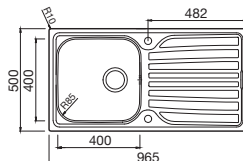
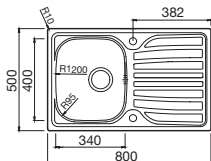



Stainless Steel

STARLINE



The **Starline** has stylish design features reinforcing its designer credentials. There are two bowl options available, offering distinctly different solutions for the kitchen. The ever useful 1.5 bowl offers multi-task capabilities and the particularly capacious single bowl model will tackle the biggest of jobs with ease.

Starline SL150 shown with Titania T125S Stainless Steel tap - see page 258

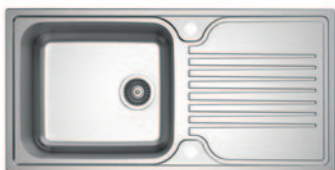

Starline Large bowl and drainer

Ref. SL100 £185

Overall size: 1000/500 mm
 Bowl size: 465/415/215 mm
 Cutout size: 980/480 mm
 Minimum cabinet size: 600 mm
 Waste included: 90 mm BSW

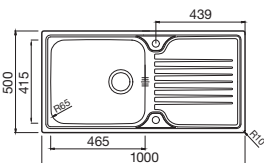

Starline 1.5 bowl and drainer

Ref. SL150 £205

Overall size: 1000/500 mm
 Bowl size: 350/415/190 mm
 Half bowl: 160/285/120 mm
 Cutout size: 980/480 mm
 Minimum cabinet size: 600 mm
 Waste included: 2 x 90 mm BSW & Plumbing Kit

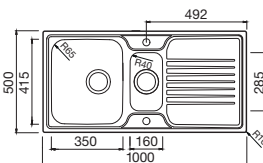



AVA



The **Ava** has a distinctive narrow 8-rib drainer pattern which provides excellent draining qualities that not only look smart but has the added benefit of increasing the Ava's overall tensile strength. All models have been treated to Silencote to add the robust and acoustic qualities.

Ava 150 shown with Morpho Brushed Nickel tap with flex and stay spout - see page 232-233

These economic trio offer versatility and excellent value for money.



Ava Single bowl and drainer
Ref. AV86 £120

Overall size: 860/500/160 mm
Bowl size: 340/400/140 mm
Cutout size: 840/480 mm
Minimum cabinet size: 450 mm
Waste included: 90 mm BSW

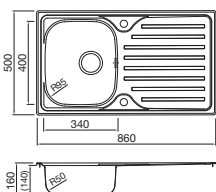

Ava Large bowl and drainer
Ref. AV100 £135

Overall size: 1000/500/160 mm
Bowl size: 400/400/140 mm
Cutout size: 980/480 mm
Minimum cabinet size: 500 mm
Waste included: 90 mm BSW

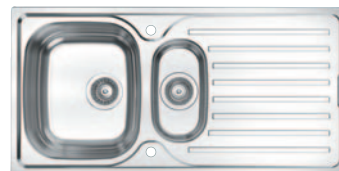
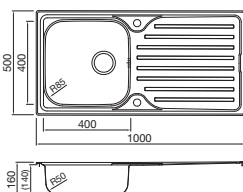

Ava 1.5 bowl and drainer
Ref. AV150 £150

Overall size: 1000/500/160 mm
Bowl size: 340/400/140 mm
Half bowl: 160/300/91 mm
Cutout size: 980/480 mm
Minimum cabinet size: 600 mm
Waste included: 2 x 90 mm BSW & Plumbing Kit

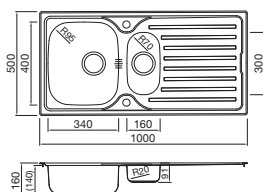

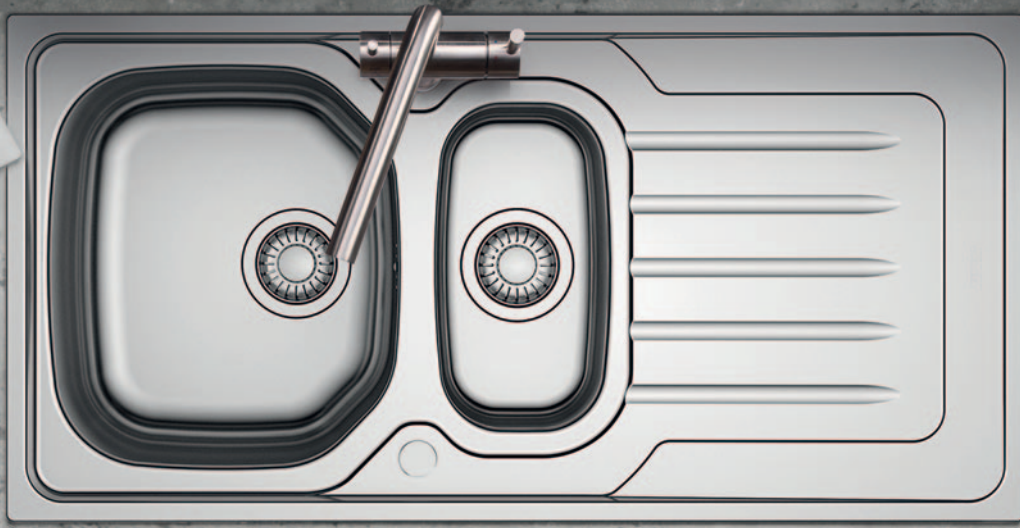

Bolero BO150 shown with Zuben Stainless Steel Filter tap - see page 209



BOLERO



The **Bolero** family of sinks offer super value for money. The three bowl configuration alternatives provide lots of design flexibility and each sink is manufactured in 0.6mm thick steel and finished in a satin finish that will ensure a long lasting smart appearance.



Bolero Single bowl and drainer

Ref. BO90 £139

Overall size: 860/500 mm
 Bowl size: 345/395/160 mm
 Cutout size: 840/480 mm
 Minimum cabinet size: 450 mm
 Waste included: 90 mm BSW

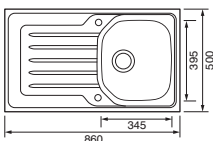

Bolero Large bowl and drainer

Ref. BO100 £147

Overall size: 1000/500 mm
 Bowl size: 450/395/160 mm
 Cutout size: 980/480 mm
 Minimum cabinet size: 500 mm
 Waste included: 90 mm BSW

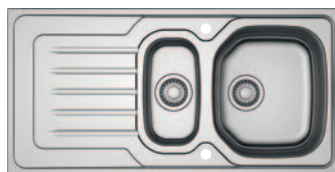
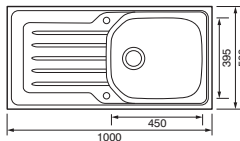

Bolero 1.5 bowl and drainer

Ref. BO150 £202

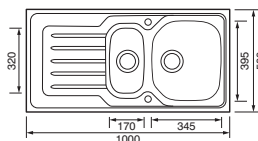

Overall size: 1000/500 mm
 Bowl size: 345/395/160 mm
 Half bowl: 170/320/80 mm
 Cutout size: 980/480 mm
 Minimum cabinet size: 600 mm
 Waste included: 2 x 90 mm BSW & Plumbing Kit



Icons Explained
 see page 96-97.







Indio IN200 shown with Juno Chrome tap - see page 228

INDIO





The **Indio** offers a wide choice of bowl options to cater for every possible kitchen demand. All models share the same distinctive linear styling that will be suitable for both contemporary and retro kitchen settings.

Juno Chrome

Karuma Chrome

Titania SS



Indio IN86 shown with Karuma Pull-out tap in Chrome - see page 246



Indio Double bowl and drainer

Ref. IN200 £230

- Overall size: 1160/500 mm
- Bowl sizes: 350/415/195 mm
- Cutout size: 1140/480 mm
- Minimum cabinet size: 900 mm
- Waste included: 2 x 90 mm BSW & Plumbing Kit

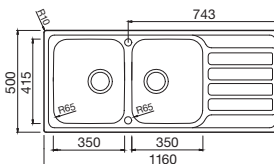



Stainless Steel



Indio IN150 shown with Titania Stainless Steel tap - see page 258



Indio 1.5 bowl and drainer

Ref. IN150 £205

Overall size: 1000/500 mm
 Bowl size: 350/415/195 mm
 Half bowl: 160/285/120 mm
 Cutout size: 980/480 mm
 Minimum cabinet size: 600 mm
 Waste included: 2 x 90 mm BSW & Plumbing Kit

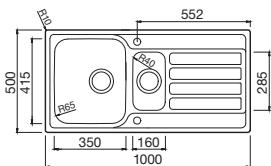

Indio Large bowl and drainer

Ref. IN100 £185

Overall size: 1000/500 mm
 Bowl size: 465/415/220 mm
 Cutout size: 980/480 mm
 Minimum cabinet size: 600 mm
 Waste included: 90 mm BSW

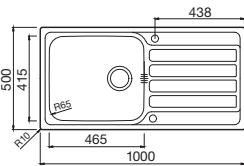

Indio Single bowl and drainer

Ref. IN86 £160

Overall size: 860/500 mm
 Bowl size: 350/415/195 mm
 Cutout size: 840/480 mm
 Minimum cabinet size: 500 mm
 Waste included: 90 mm BSW

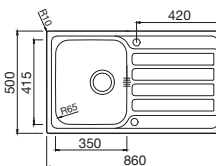

Icons Explained
 see page 96-97.

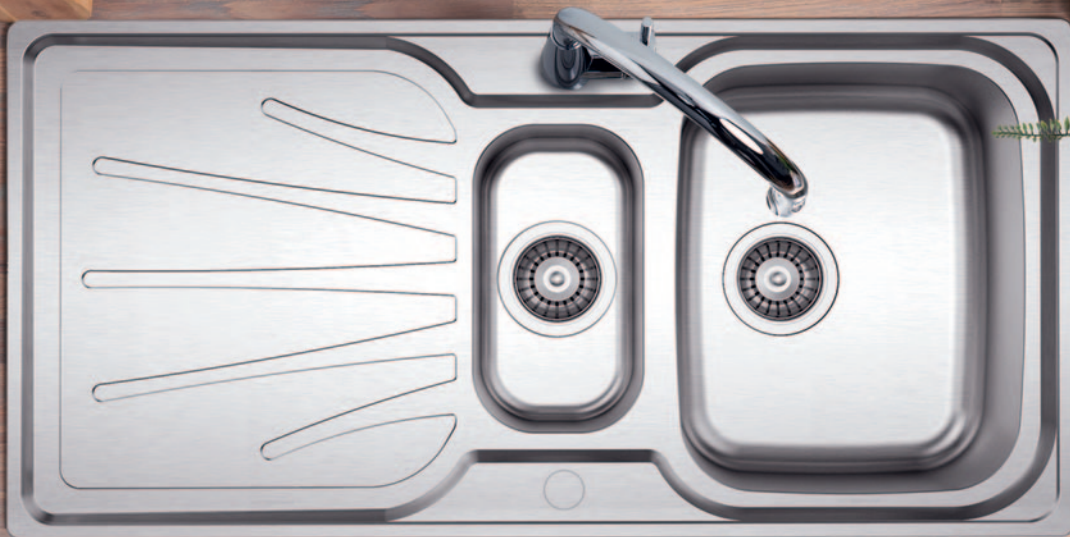

DEEP BLUE



Three solidly constructed sinks with star-burst drainer patterns that offer a cheerful feel to your kitchen. Manufactured from 0.8 gauge 18/10 stainless steel which also benefits from **SilentCote®**, a special sound-proofing under-coat paint which further adds to the Deep Blue's durability.

Optional Accessories



Ref. DSO4 (DB5 & 15)
Stainless Steel Basket
with plate rack £46



Deep Blue DB15B shown with
Porrina Pull-out tap in Chrome - see page 249



Deep Blue Single bowl and drainer
Ref. DB5 £190

Overall size: 800/500/170 mm
Bowl size: 340/400/155 mm
Cutout size: 780/480 mm
Minimum cabinet size: 450 mm
Waste included: 90 mm BSW

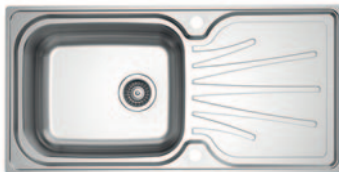

Deep Blue Large bowl and drainer
Ref. DB10 Brushed £235

Overall size: 1000/500 mm
Bowl size: 480/400/220 mm
Cutout size: 980/480 mm
Minimum cabinet size: 600 mm
Waste included: 90 mm BSW

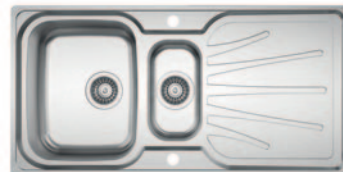

Deep Blue 1.5 bowl and drainer
Ref. DB15 Brushed £239

Overall size: 1000/500 mm
Bowl size: 332/400/190 mm
Half bowl: 162/300/115 mm
Cutout size: 980/480 mm
Minimum cabinet size: 600 mm
Waste included: 2 x 90 mm BSW & Plumbing Kit

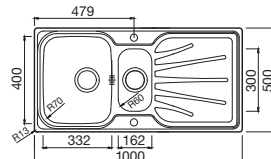
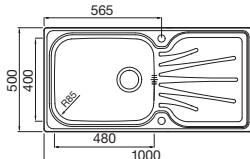
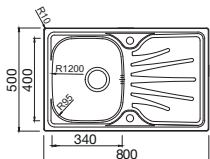



Kudos KU790 shown with Karuma Pull-out tap in Chrome - see page 246

KUDOS



The competitively priced **Kudos** has bold design elements not usually found on eco-priced sinks. Amongst its group of three is a useful double bowl model that is ideal for a multi-tasking.



Kudos Small bowl and drainer

Ref. KU790 £175

Overall size: 790/500 mm
Bowl size: 340/405/170 mm
Cutout size: 770/480 mm
Minimum cabinet size: 450 mm
Waste included: 90 mm BSW

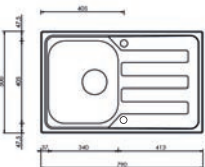

Kudos 1.5 bowl and drainer

Ref. KU150 £210

Overall size: 1000/500 mm
Bowl size: 340/380/160 mm
Half bowl: 170/330/100 mm
Cutout size: 975/490 mm
Minimum cabinet size: 600 mm
Waste included: 90 mm BSW & Plumbing Kit

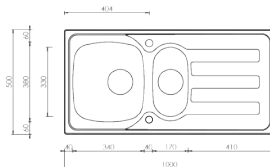

Kudos Double bowl and drainer

Ref. KU200 £220

Overall size: 1160/500 mm
Bowl sizes: 340/405/170 mm
Cutout size: 1135/475 mm
Minimum cabinet size: 800 mm
Waste included: 2 x 90 mm BSW & Plumbing Kit

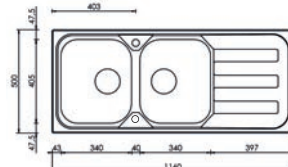



Okio small shown with Creta tap in Chrome - see page 241

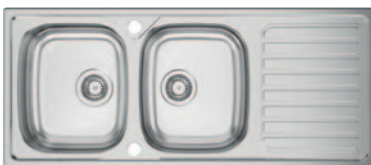

Okio Double bowl and drainer

Ref. 7510823 £303

Overall size: 1200/500 mm
 Bowl sizes : 340/400/160 mm
 Cutout size: 1176/476 mm
 Minimum cabinet size: 800 mm
 Waste included: 2 x 90 mm BSW
 & Plumbing Kit

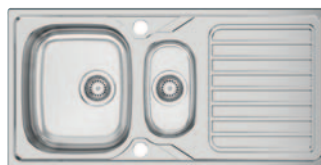
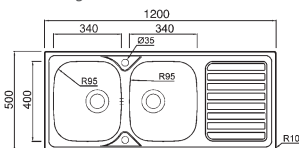

Okio 1.5 bowl and drainer

Ref. 7510423 £280

Overall size: 1000/500 mm
 Bowl size: 340/400/160 mm
 Half bowl: 160/350/90 mm
 Cutout size: 976/476 mm
 Minimum cabinet size: 600 mm
 Waste included: 2 x 90 mm BSW & Plumbing Kit

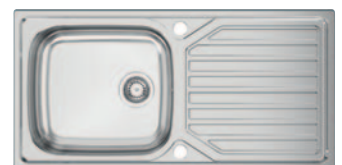
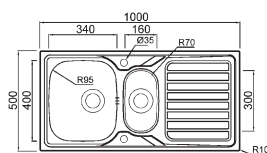

Okio Large bowl and drainer

Ref. 7510723 £228

Overall size: 1000/500 mm
 Bowl size: 450/400/160 mm
 Cutout size: 976/476 mm
 Minimum cabinet size: 500 mm
 Waste included: 90 mm BSW

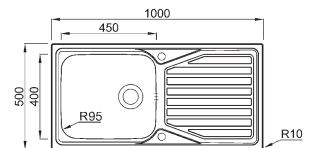



Okio 1.5 bowl shown with Juno tap in Chrome - see page 228

OKIO



The **Okio** range offers great practicality with contemporary styling, there are six options including a really useful double bowl model - ideal for high use kitchens. All models are manufactured from 0.6mm gauge stainless steel and can be fitted as left or right hand drainers.

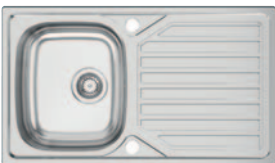

Okio Single bowl and drainer
Ref. 7507123 £180

Overall size: 860/500 mm
Bowl size: 340/400/160 mm
Cutout size: 836/476 mm
Minimum cabinet size: 450 mm
Waste included: 90 mm BSW

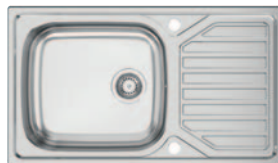
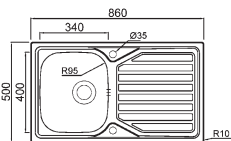

Okio Large bowl and small drainer
Ref. OK86L £180

Overall size: 860/500 mm
Bowl size: 450/400/160 mm
Cutout size: 836/476 mm
Minimum cabinet size: 500 mm
Waste included: 90 mm BSW

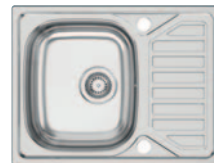
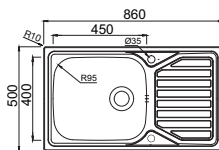

Okio Small bowl & drainer
Ref. 7510223 £195

Overall size: 650/500 mm
Cutout size: 630/480 mm
Bowl depth: 160 mm
Minimum cabinet size: 450 mm
Waste included: 90mm BSW

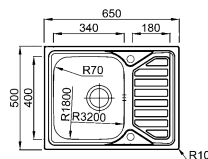

Icons Explained
see page 96-97.

VIVA



The **Viva's** most notable features include three bold drainer panels and a slim-edge profile that creates a near flush setting with the work surface. Three bowl options include a catering-size single bowl and a compact version for the smaller kitchen and not forgetting the indispensable 1.5 bowl also playing its role.



Viva V1151 shown with Juno tap in Chrome - see page 228



Viva Single bowl and drainer

Ref. V1870 £350

Overall size: 870/510 mm
 Bowl size: 342/410/210 mm
 Cutout size: 850/490 mm
 Minimum cabinet size: 450 mm
 Waste included: 90 mm BSW



Viva Large bowl and drainer

Ref. V1101 £395

Overall size: 1010/510 mm
 Bowl size: 500/400/210 mm
 Cutout size: 990/490 mm
 Minimum cabinet size: 600 mm
 Waste included: 90 mm BSW



Viva 1.5 bowl and drainer

Ref. V1151 £405

Overall size: 1010/510 mm
 Bowl size: 342/410/210 mm
 Half bowl: 145/335/130 mm
 Cutout size: 990/490 mm
 Minimum cabinet size: 600 mm
 Waste included: 90 mm BSW & Plumbing Kit

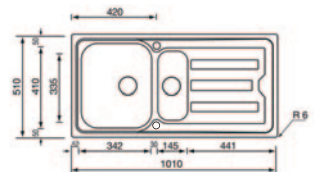
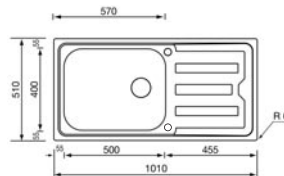
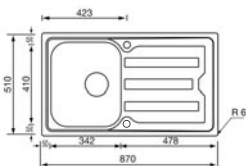









Stainless Steel

Monza MN150 shown with Magus 3 Kettle tap in Chrome - see page 176 - 177



MONZA

316 L STAINLESS STEEL

LIFE TIME

LIFETIME WARRANTY

The **Monza's** sharper radius bowls are complimented by unique drainer channels that provide rather a dynamic aesthetic. The Monza collection offer three bowl options that should fulfil most busy kitchen demands, particularly the 'workhorse' double-bowl option.



Monza Single bowl and drainer

Ref. MN860 £340

Overall size: 860/500 mm
 Bowl size: 340/400/210 mm
 Cutout size: 835/475 mm
 Minimum cabinet size: 450 mm
 Waste included: 90 mm BSW

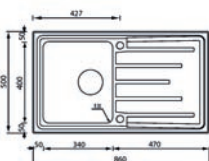

Monza 1.5 bowl and drainer

Ref. MN150 £379

Overall size: 1000/500 mm
 Bowl size: 340/400/210 mm
 Half bowl: 145/335/140 mm
 Cutout size: 975/475 mm
 Minimum cabinet size: 600 mm
 Waste included: 90 mm BSW & Plumbing Kit

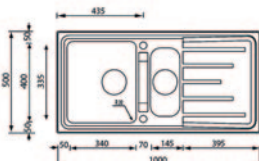

Monza Double bowl and drainer

Ref. MN200 £445

Overall size: 1160/500 mm
 Bowl size: 340/400/210 mm
 Cutout size: 1135/475 mm
 Minimum cabinet size: 800 mm
 Waste included: 90 mm BSW & Plumbing Kit

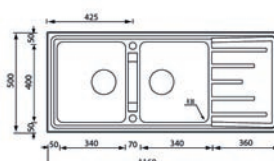



Cresta CR100 shown with Magus 3 Kettle tap in Chrome - see page 176 -177



Cresta Large bowl and drainer

Ref. CR100 £310

Overall size: 1000/500 mm
 Bowl size: 500/400/210 mm
 Cutout size: 975/475 mm
 Minimum cabinet size: 600 mm
 Waste included: 90 mm BSW

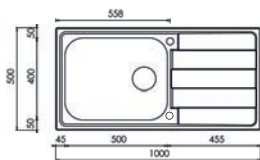

CRESTA



The **Cresta** offers four practical sink choices including a capacious single bowl with catering scale proportions. All models feature stylish drainer architecture and have slightly squarer bowl shapes that reinforce the Cresta's smart modernity.



Cresta Single bowl and drainer

Ref. CR860 £250

Overall size: 860/500 mm
 Bowl size: 342/410/210 mm
 Cutout size: 835/475 mm
 Minimum cabinet size: 450 mm
 Waste included: 90 mm BSW

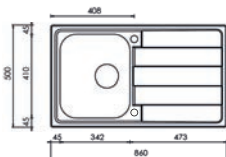

Cresta 1.5 bowl and drainer

Ref. CR150 £320

Overall size: 1000/500 mm
 Bowl size: 342/410/210 mm
 Half bowl: 145/335/130 mm
 Cutout size: 975/475 mm
 Minimum cabinet size: 600 mm
 Waste included: 90 mm BSW & Plumbing Kit

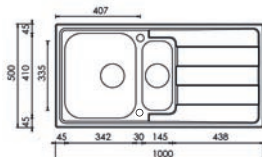

Cresta Double bowl and drainer

Ref. CR200 £330

Overall size: 1160/500 mm
 Bowl sizes: 342/410/210 mm
 Cutout size: 1135/475 mm
 Minimum cabinet size: 800 mm
 Waste included: 2 x 90 mm BSW & Plumbing Kit

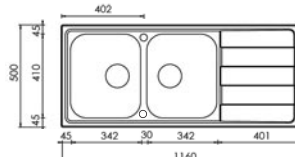



Solar SO150L shown with Juno tap in Chrome - see page 228

SOLAR



This elegant sink range has been designed with smart understated features that ooze class. Sharp corners symmetrical draining flutes and robust engineering ensure enduring good looks.



Juno tap in Chrome - see page 228



Solar Single bowl and drainer
Ref. SO86L LH Drainer £305
Ref. SO86R RH Drainer £305

Overall size: 860/500 mm
 Bowl size: 350/400/215 mm
 Cutout size: 840/480 mm
 Minimum cabinet size: 600 mm
 Waste included: 90 mm BSW

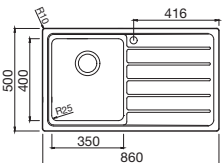

Solar Single bowl and drainer
Ref. SO100L LH Drainer £325
Ref. SO100R RH Drainer £325

Overall size: 1000/500 mm
 Bowl size: 450/400/215 mm
 Cutout size: 980/480 mm
 Minimum cabinet size: 600 mm
 Waste included: 90 mm BSW

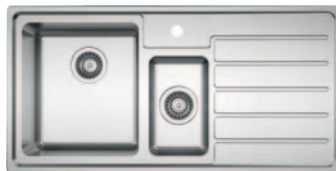
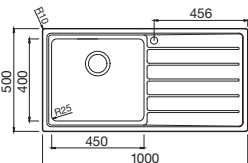

Solar 1.5 bowl and drainer
Ref. SO150L LH Drainer £355
Ref. SO150R RH Drainer £355

Overall size: 1000/500 mm
 Bowl size: 350/400/215 mm
 Half bowl: 180/xxx/135 mm
 Cutout size: 980/480 mm
 Minimum cabinet size: 600 mm
 Waste included: 2 x 90 mm BSW
 & Plumbing Kit

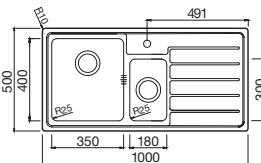

Icons Explained
 see page 96-97.



Xeron 86 Single bowl and drainer

Ref. MH1F143A2 LHD **£633**

Ref. MH1F243A2 RHD **£633**

Overall size: 860/520 mm
 Bowl size: 400/400/200 mm
 Cutout size: 842/502 mm
 Minimum cabinet size: 500 mm
 Waste included: 90 mm BSW

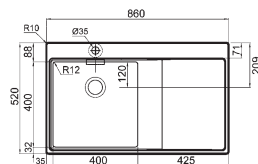

Xeron B50 Single bowl and double drainer

Ref. MO1F443A2 **£800**

Overall size: 1160/520 mm
 Bowl size: 500/400/200 mm
 Cutout size: 1142/502 mm
 Minimum cabinet size: 600 mm
 Waste included: 90 mm BSW

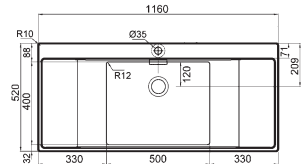



Xeron 100 shown with Mariner Filter tap in Brushed Nickel - see pages 194 -195

Stainless Steel

XERON



Optional Accessories



Ref. 04521
Stainless Steel Colander **£195**

These sophisticated hand finished sinks are our most geometrically shaped models and have been planned with aesthetics and practicality in mind. They are manufactured using only the highest quality 1.2mm stainless steel and have been brush polished resulting in a lustrous grained finish. There are four different configurations including a double drainer model which is ideal for particularly high use kitchens.



Xeron 105 Large bowl and drainer

Ref. ML1F143A2 LHD **£693**
Ref. ML1F243A2 RHD **£693**

Overall size: 1000/520 mm
Bowl size: 500/400/200 mm
Cutout size: 982/502 mm
Minimum cabinet size: 600 mm
Waste included: 90 mm BSW

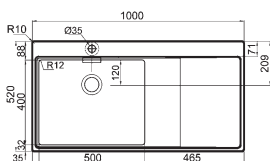

Xeron 100 1.5 bowl and drainer

Ref. ML7F148A2 LHD **£851**
Ref. ML4F128A2 RHD **£851**

Overall size: 1000/520 mm
Bowl size: 340/400/200 mm
Half bowl: 170/400/170 mm
Cutout size: 982/502 mm
Minimum cabinet size: 600 mm
Waste included: 2 x 90 mm BSW & Plumbing Kit

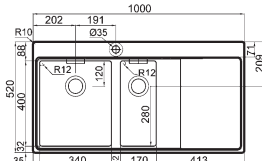



Zenith ZE100R shown with Titania T12SS Stainless Steel tap - see page 258



Zenith Single bowl and drainer
Ref. ZE100L LH Drainer £548
Ref. ZE100R RH Drainer £548

Overall size: 920/510 mm
 Bowl size: 440/415/205 mm
 Cutout size: 902/492 mm
 Minimum cabinet size: 500 mm
 Pop-up waste included: 90 mm BSW

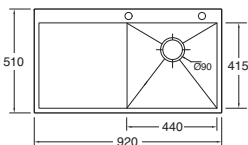

Zenith 1.5 bowl and drainer
Ref. ZE150L LH Drainer £597
Ref. ZE150R RH Drainer £597

Overall size: 1000/510 mm
 Bowl size: 365/415/205 mm
 Half bowl: 180/415/150 mm
 Cutout size: 982/492 mm
 Minimum cabinet size: 700 mm
 Pop-up waste included: 2 x 90 mm BSW & Plumbing Kit

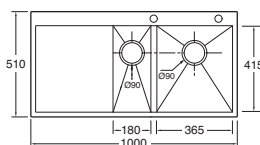

Optional Accessories



Ref. WBD433
 Wooden Chopping Board £37



Ref. COL415
 Stainless Steel Colander £120
Fits all bowls



Ref. TR415
 Stainless Steel Tray £46
Fits all bowls



ZENITH



Zenith ZE150R shown with Titania TI2SS Stainless Steel tap - see page 258

The **Zenith** sinks radiate cool minimalism with strong geometric lines. This family of sinks offer deeply recessed flat drainers that are sloped for easy drain-off.

The omission of draining ribs compliment the sharp radii corners and maximise the useable work surface and offer easy to wipe down surfaces.

The unusually strong construction has been made possible by using the highest quality 1.6mm thick steel which has been brushed to create a beautiful grained sheen. To further add to this sink's credentials all models have been treated with **SilentCote®** a thermal soundproofing paint.

Presto Automatic Waste - Included with the Zenith





Urban UR660 shown with Zuben Stainless Steel Filter tap - see page 209



Urban Single bowl
Ref. UR440 £354

Overall size: 440/510 mm
Bowl size: 400/400/200 mm
Minimum cabinet size: 500 mm
Waste included: 90 mm BSW

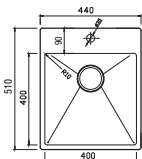

Urban Single bowl
Ref. UR540 £376

Overall size: 540/510 mm
Bowl size: 500/400/200 mm
Minimum cabinet size: 600 mm
Waste included: 90 mm BSW

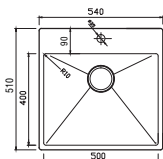

Urban Single bowl
Ref. UR660 £465

Overall size: 660/515 mm
Bowl size: 610/400/200 mm
Minimum cabinet size: 800 mm
Waste included: 90 mm BSW

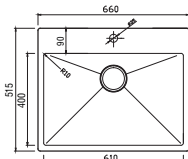

Urban 1.75 bowl
Ref. UR810 £713

Overall size: 810/450 mm
Bowl size: 400/400/200 mm
.75 bowl: 330/350/200 mm
Minimum cabinet size: 900 mm
Waste included: 2 x 90 mm BSW & Plumbing Kit

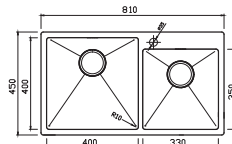

URBAN



The **Urban** are a very slick range of sinks, the bowls feature 10mm radius corners and smart draining lines enhancing their crisp architectural appearance.

The sinks are manufactured in a 1.2mm steel which has been further reinforced with **SilentCote®**, a special sound-proofing thermal paint (see page 85).

Optional Accessories



Ref. WBD426
Wooden Chopping Board £37



Ref. RM2000 Stainless Steel Draining Mat (round bar) £59

Ref. DR3000 Stainless Steel Draining Mat (square bar) £59
see page 141



Urban UR660 shown here with Bellatrix Professional filter tap - *see page 200 -201*

Stainless Steel



10mm corners



Flat edge profile



Urban UR810 shown with Auriga Pull-out tap in Chrome/Nero - *see page 251*



Urban Smart Ref UCS004 shown with Rosetta Filter tap in Brushed Nickel - see page 196



Urban Smart Single bowl
Ref. UCS001 £531

Overall size: 440/520 mm
Bowl size: 380/370/220 mm
Cutout size: 420/500 mm
Minimum cabinet size: 500 mm
Waste included: 90 mm BSW

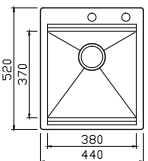

Urban Smart Single bowl
Ref. UCS002 £560

Overall size: 540/520 mm
Bowl size: 480/370/220 mm
Cutout size: 520/500 mm
Minimum cabinet size: 600 mm
Waste included: 90 mm BSW

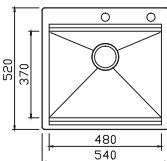

Urban Smart Single bowl
Ref. UCS003 £592

Overall size: 660/520 mm
Bowl size: 600/370/220 mm
Cutout size: 640/500 mm
Minimum cabinet size: 700 mm
Waste included: 90 mm BSW

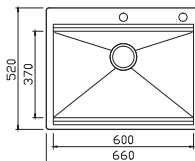

Urban Smart Single bowl
Ref. UCS004 £670

Overall size: 800/520 mm
Bowl size: 740/370/220 mm
Cutout size: 780/500 mm
Minimum cabinet size: 800 mm
Waste included: 90 mm BSW

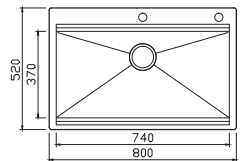



Urban Smart Ref UCS003 shown with Rosetta Filter tap in Brushed Nickel - see page 196

ACCESSORIES Included



Ref. WBD426
Wooden Chopping Board



Ref. DB04
Stainless Steel Tray



Presto Automatic Waste

ACCESSORIES Optional



Ref. COL101
Stainless Steel Colander £120

URBAN SMART



The **Urban Smart** sinks are the perfect cook's assistant – custom-fit accessories including strainer colanders and trays can rest on the double-level bowl ledges freeing up hands for food prep tasks such as rinsing vegetables and straining pasta. The top ledge is used for the sliding wooden chopping board and the lower ledge is for the strainer accessories that can also slide for optimum positioning. These bespoke accessories included with the sink truly maximize the Urban Smart's abilities.

The tap-hole employed by the Presto Automatic Waste control can be made available for a secondary tap such as a Filter/Kettle tap or soap dispenser by requesting a manual waste instead of an automatic.



BELLA



The **Bella** boasts a generous size half bowl and has a sharp flat profile edge which appears almost flush to the worktop.



Bella 1.5 bowl
Ref. **BE625** £332

Overall size: 625/520 mm
Bowl size: 340/400/185 mm
Half bowl: 180/396/120 mm
Cutout size: 610/505 mm
Minimum cab size: 600 mm
Waste included: 2 x 90 mm BSW & Plumbing Kit

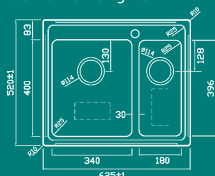

Ref. **COL105**
Stainless Steel Colander £83
Fits main bowl only

Bella shown with Rococo Twist & Spray tap in Chrome - see page 224

BAR 47



The **Bar 47** sink is a great choice as an additional sink for entertaining and is also an ideal solution for mini kitchens.



Bar 47 Single bowl
Ref. **BA470** £204

Overall size: 480/480 mm
Bowl size: 400/340/160 mm
Cutout size: 460/460 mm
Minimum cab size: 600 mm
Waste included: 90 mm BSW

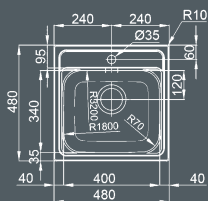

PIO BAR



Sister sink to the Bar 47 the **Pio Bar** is a little more compact, able to squeeze into the smallest installation.



Pio Bar Single bowl
Ref. **PB380** £155

Overall size: 380/380 mm
Bowl size: 305/260/135 mm
Cutout size: 356/356 mm
Minimum cab size: 450 mm
Waste included: 90 mm BSW

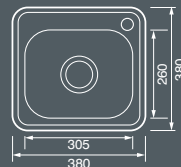

OBOE



A perfect sink if space is tight, whilst retaining a useful size washing bowl.

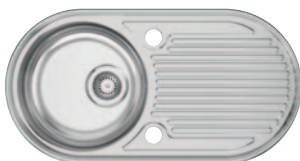

Oboe Single bowl and drainer
Ref. 8135 Satin **£174**

Overall size: 847/444 mm
 Bowl size: 367/367/145 mm
 Cutout size: 823/420 mm R210
 Minimum cabinet size: 450 mm
 Waste included: 90 mm BSW

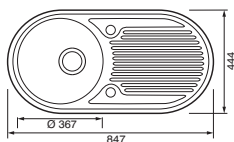

Oboe shown with Creta tap in Chrome - see page 241

Stainless Steel



Arco Single bowl
Ref. RB450B **£128**
 Overall size: Ø440 mm
 Bowl size: Ø390/185 mm
 Cutout size: Ø416 mm
 Minimum cabinet size: 450 mm
 Waste included: 90 mm BSW

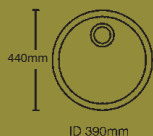

ARCO MINI



Arco Mini Single bowl
Ref. 25201 **£192**
 Overall size: Ø355 mm
 Bowl size: Ø305/170 mm
 Cutout size: Ø335 mm
 Minimum cab size: 350 mm
 Waste included: 60 mm BSW



BASICS INSET



Basic Insets are the contractors' favorite sinks for low cost housing contracts where assured quality and budget prices are key.

0.7 and BS equivalent 0.9 gauge steel options are available.



Shallow Bowl Sink



Basic 935 x 485 Single Bowl Inset Sink

Overall size	935/485 mm
Bowl size	405/345/165 mm
Cutout size	915/465 mm
Min cabinet size	500 mm
Waste included	90 mm BSW
Tap hole	1 Handed

Ref. BAL1TH LH Drainer **£104**
Ref. BAR1TH RH Drainer **£104**
 Steel Gauge: 0.7 mm



Ref. BSL1TH LH Drainer **£154**
Ref. BSR1TH RH Drainer **£154**
 Steel Gauge: 0.9 mm



Basic 935 x 485 Single Bowl Inset Sink

Overall size	935/485 mm
Bowl size	405/345/165 mm
Cutout size	915/465 mm
Min cabinet size	500 mm
Waste included	90 mm BSW
Tap hole	2 Handed

Ref. BAL2TH LH Drainer **£104**
Ref. BAR2TH RH Drainer **£104**
 Steel Gauge: 0.7 mm



Ref. BSL2TH LH Drainer **£154**
Ref. BSR2TH RH Drainer **£154**
 Steel Gauge: 0.9 mm



Basic 950 x 508 Single Bowl Inset Sink Shallow Bowl

Overall size	950/508 mm
Bowl size	420/350/120 mm
Cutout size	930/488 mm
Min cabinet size	500 mm
Steel gauge	0.6 mm
Tap hole	Reversible

Ref. PH940 **£186**
 Suitable for wheelchair users
 Waste & Overflow **Ref. WCWO** **£7**

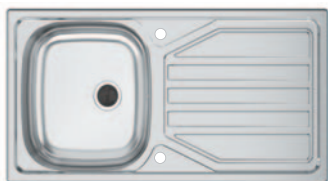

Basic 860 x 435 Single Bowl Inset Sink Spacesaver

Overall size	860/435 mm
Bowl size	340/370/150 mm
Cutout size	836/411 mm
Min cabinet size	600 mm
Waste included	60 mm Ring Plug
Tap hole	Reversible

Ref. SS86RS **£105**



Basic 1310 x 510 Single Bowl Inset Sink Double Drainer

Overall size	1310/510 mm
Bowl size	400/340/160 mm
Cutout size	1290/490 mm
Min cabinet size	500 mm
Steel Gauge	0.7 mm
Tap hole	1 or 2 Handed

Ref. SBDD1 **£361** 1 Tap Hole
Ref. SBDD2 **£361** 2 Tap Holes
 Waste & Overflow **Ref. WCWO** **£7**



BASICS

LAY-ON



SATIN



Basic Lay-On fit directly on to the kitchen cabinet and are not set into a work-top, therefore maximising the wet area.

Each sink is supplied with twin tap-holes for either traditional pillar taps or deck mixer style taps.

Please see page 264-265 for our recommended tap range.



Basic Lay-On Sink shown with Venue pillar taps - see page 264

Stainless Steel



Basic 1000 x 500 Single Bowl Lay-On Sink Square Front 105

Overall size	1000/500 mm
Bowl size	420/350/160 mm
Front profile	30 mm
Ledge	30 mm
Centres	180 mm
Steel gauge	0.6 mm
Tap hole	2 Handed

Ref. **105SFL** LH Drainer **£169**

Ref. **105SFR** RH Drainer **£169**

Waste & Overflow Ref. **WCWO** **£7**



Basic 1000 x 600 Single Bowl Lay-On Sink Square & Roll Front 106

Overall size	1000/600 mm
Bowl size	400/420/160 mm
Front profile	30 mm
Ledge	30 mm
Centres	180 mm
Steel gauge	0.6 mm
Tap hole	2 Handed

Square Front

Ref. **106SFL** LH Drainer **£189**

Ref. **106SFR** RH Drainer **£189**

Roll Front

Ref. **106RFL** LH Drainer **£219**

Ref. **106RFR** RH Drainer **£219**

Waste & Overflow Ref. **WCWO** **£7**



Basic 1600 x 543 Single Bowl Lay-On Sink Double Drainer, Square Front

Overall size	1600/543 mm
Bowl size	400/400/155 mm
Steel gauge	0.7 mm
Tap hole	2 Handed

Ref. **63DDSF** **£299**

Waste & Overflow Ref. **WCWO** **£7**



Icons Explained
see page 96-97.

UNDERMOUNT

We offer a huge choice of stainless steel undermount sinks, from soft form to zero radius bowls and compact to capacious; you can be assured you will find the perfect solution for your needs. Also, amongst the undermount pages you will see our Smart series which offer fitted accessories to broaden versatility.



This installation requires the sink to be fitted to the worktop from the underside. This installation type is only suitable for solid surface worktops such as Granite, Marble or Wood.



Vortex VO850 shown with Juno tap in Chrome - see page 228

Stainless Steel



Vortex VO850 shown with Auriga Pull-out tap in Chrome/Black - see page 251



Vortex Single bowl and drainer

Ref. VO850 £480

Overall size: 850/440 mm
 Bowl size: 405/400/190 mm
 Cutout size: Template Available
 Minimum cabinet size: 1000 mm
 Waste included: 90 mm BSW

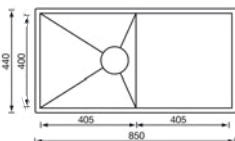

Vortex Large bowl and drainer

Ref. VO990 £505

Overall size: 990/440 mm
 Bowl size: 475/400/190 mm
 Cutout size: Template Available
 Minimum cabinet size: 1200 mm
 Waste included: 90 mm BSW

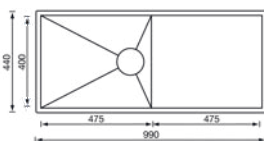

VORTEX UNDERMOUNT



The **Vortex** is the next generation of undermount sinks combining a bowl with a drainer. This is a perfect solution for those who want the modernity and sleek looks that undermounts provide but want to avoid using the worktop as a drying area. This is a single-piece handcrafted sink that sits beautifully beneath a solid surface worktop offering sophistication and practicality.

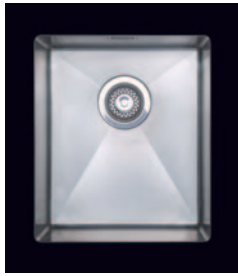

Jazz Single bowl
Ref. JA014 £248
 Overall size: 380/440 mm
 Bowl size: 340/400/190 mm
 Min cabinet size: 400 mm

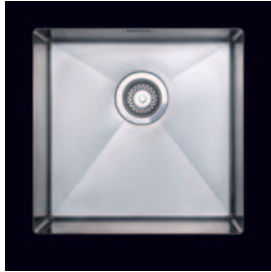
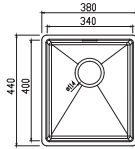

Jazz Single bowl
Ref. JA012 £274
 Overall size: 450/440 mm
 Bowl size: 410/400/190 mm
 Min cabinet size: 450 mm

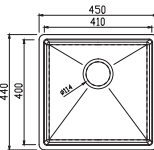

Jazz Single bowl
Ref. JA013 £314
 Overall size: 590/440 mm
 Bowl size: 550/400/190 mm
 Min cabinet size: 600 mm

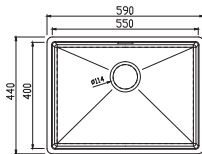

Jazz Double bowl
Ref. JA024 £500
 Overall size: 750/440 mm
 Bowl sizes: 340/400/190 mm
 Minimum cabinet size: 800 mm

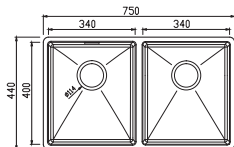

Jazz 1.5 bowl
Ref. JA022LH LH Main Bowl £500
Ref. JA022RH RH Main Bowl £500
 Overall size: 800/440 mm
 Bowl size: 550/400/190 mm
 Half bowl: 180/400/125 mm
 Minimum cabinet size: 800 mm

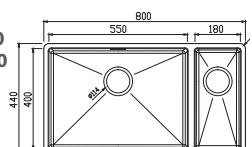

JAZZ UNDERMOUNT/INSET



The **Jazz** offers amazing value for money when you consider its excellent credentials. Constructed from a robust 1.0mm stainless steel and treated with **SilentCote®** for added hushed tones when in use. Fine radius corners for an ultra-contemporary aesthetic, a brushed grained finish with smart draining lines on the bowl floor to aid rapid draining.

The decorative graining extends to the normally unseen rim which means all models can be installed in both undermount and inset formats as well.

Optional Accessories



Ref. COL103
 Stainless Steel Colander **£120**



Ref. COL105
 Stainless Steel Colander **£83**



Ref. RM2000 Stainless Steel Draining Mat (round bar) **£59**
Ref. DR3000 Stainless Steel Draining Mat (square bar) **£59**





Jazz JA021RH shown with Titania TI25S Stainless Steel tap - see page 258



90mm Strainer Waste
included with all sinks



Plumbing Kit
included with multi-bowl sinks



Deluxe Strainer Waste (upgrade)
Chrome **£20**
Brushed **£32**

Undermount Cutouts
DXF drawings are available for download.



Jazz 1.5 bowl
Ref. JA021LH LH Main Bowl **£477**
Ref. JA021RH RH Main Bowl **£477**
Overall size: 660/440 mm
Bowl size: 410/400/190 mm
Half bowl: 180/400/125 mm
Minimum cabinet size: 700 mm

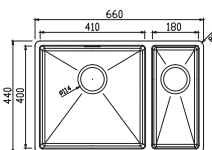

Jazz 1.5 bowl
Ref. JA023LH LH Main Bowl **£465**
Ref. JA023RH RH Main Bowl **£465**
Overall size: 590/440 mm
Bowl size: 340/400/190 mm
Half bowl: 180/400/125 mm
Min cabinet size: 600 mm

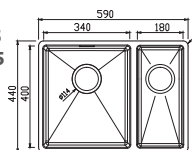

Icons Explained
see page 96-97.

SALSA UNDERMOUNT



The **Salsa** are a mid-priced range of undermounts with smart contemporary styling, with 25mm radius corners and are constructed from 0.8mm steel. All Salsa sinks are coated with **SilentCote®** sound-proofing thermal paint (see page 97).

There are five double bowl and five single bowl models to choose from - all of which can be mixed and matched to create the perfect sink solution.



Optional Accessories



Ref. COL103
Stainless Steel Colander **£120**



Ref. COL105
Stainless Steel Colander **£83**

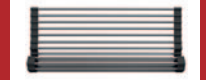

Ref. RM2000 Stainless Steel Draining Mat (round bar) **£59**
Ref. DR3000 Stainless Steel Draining Mat (square bar) **£59**



Salsa 1.5 bowl
Ref. SA60L LH Main Bowl **£496**
Ref. SA60R RH Main Bowl **£496**

Overall size: 600/450 mm
Bowl size: 340/400/180 mm
Half bowl: 180/396/120 mm
Minimum cabinet size: 600 mm

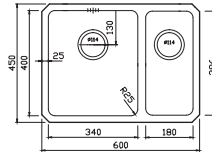

Salsa 1.5 bowl
Ref. SA74L LH Main Bowl **£539**
Ref. SA74R RH Main Bowl **£539**

Overall size: 740/450 mm
Bowl size: 480/400/195 mm
Half bowl: 180/396/120 mm
Minimum cabinet size: 800 mm

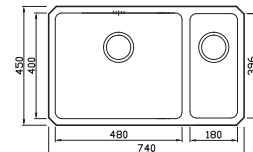

Salsa 1.5 bowl
Ref. SA90L LH Main Bowl **£559**
Ref. SA90R RH Main Bowl **£559**

Overall size: 910/450 mm
Bowl size: 650/400/200 mm
Half bowl: 180/396/120 mm
Minimum cabinet size: 1000 mm

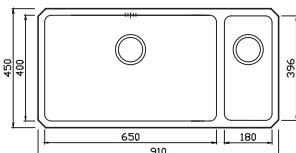

Salsa 1.5 bowl
Ref. SA53L LH Main Bowl **£485**
Ref. SA53R RH Main Bowl **£485**

Overall size: 580/450 mm
Bowl size: 340/400/190 mm
Half bowl: 160/300/120 mm
Minimum cabinet size: 600 mm

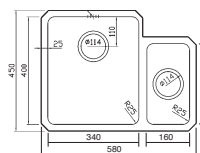

Salsa Double bowl
Ref. SA77 **£539**

Overall size: 760/450 mm
Bowl sizes: 340/400/190 mm
Minimum cabinet size: 800 mm

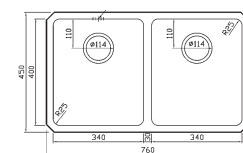

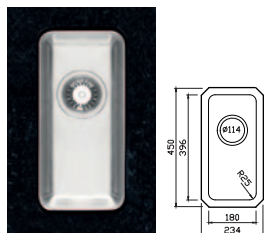

Salsa Single bowl
Ref. SA20 £194

Overall size: 234/450 mm
Bowl size: 180/396/120 mm
Minimum cabinet size: 300 mm

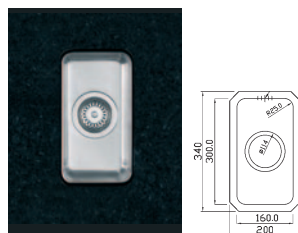

Salsa Half bowl
Ref. SA16 £222

Overall size: 200/340 mm
Bowl size: 160/300/120 mm
Minimum cabinet size: 300 mm



Salsa SA74L shown with Tutti Twist & Spray tap - see page 225



Salsa Single bowl
Ref. SA65 £463

Overall size: 700/450 mm
Bowl size: 650/400/200 mm
Minimum cabinet size: 800 mm

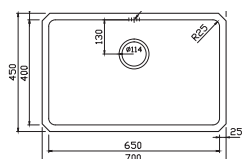

Salsa Single bowl
Ref. SA48 £371

Overall size: 530/450 mm
Bowl size: 480/400/200 mm
Minimum cabinet size: 600 mm

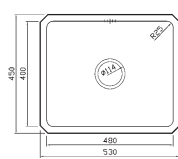

Salsa Single bowl
Ref. SA34 £305

Overall size: 390/450 mm
Bowl size: 340/400/190 mm
Minimum cabinet size: 400 mm

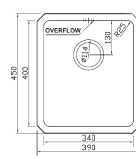

90mm Strainer Waste
included with all sinks



Plumbing Kit
included with multi-bowl sinks



Deluxe Strainer Waste (upgrade)
Chrome £20
Brushed £32

Undermount Cutouts

DXF drawings are available for download.



Tango SP500 shown with Juno tap in Chrome - see page 228



Tango 1.5 bowl (Reversible)
Ref. SP20 £260
 Overall size: 594/460 mm
 Bowl size: 350/410/185 mm
 Half bowl: 164/300 mm
 Minimum cabinet size: 600 mm

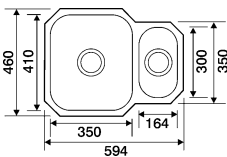

Tango Single bowl
Ref. SP164 £70
 Overall size: 204/340 mm
 Bowl size: 164/300/100 mm
 Min cabinet size: 300 mm

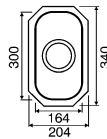

Tango Single bowl
Ref. SP350 £140
 Overall size: 340/400 mm
 Bowl size: 290/350/165 mm
 Minimum cabinet size: 400 mm

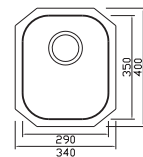

Tango Single bowl
Ref. SP410 £190
 Overall size: 440/385 mm
 Bowl size: 410/355/180 mm
 Minimum cabinet size: 450 mm

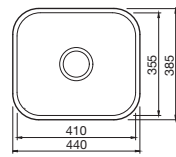



TANGO UNDERMOUNT



The softer corners of the Tango Undermounts offer a more traditional aesthetic. There are an abundance of sizes and bowl configurations to choose from, so you can create the ideal sink solution for your kitchen. All models benefit from **SilentCote®** soundproofing that also add to the sinks' robust character.



Tango Single bowl
Ref. SP400 £180
 Overall size: 446/440 mm
 Bowl size: 406/406/180 mm
 Minimum cabinet size: 450 mm

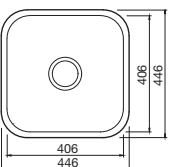

Tango Single bowl
Ref. SP480 £240
 Overall size: 530/450 mm
 Bowl size: 480/400/195 mm
 Minimum cabinet size: 600 mm

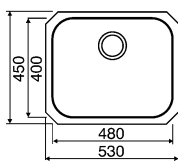

Tango Single bowl
Ref. SP500 £260
 Overall size: 533/433 mm
 Bowl size: 500/400/200 mm
 Minimum cabinet size: 600 mm

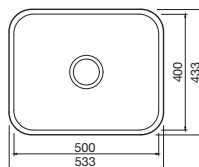

90mm Strainer Wastes
 included with all sinks



Plumbing Kit
 included with multi-bowl sinks



Deluxe Strainer Waste (upgrade)
 Chrome £20
 Brushed £32

Undermount Cutouts
 DXF drawings are available for download.



Optional Accessories

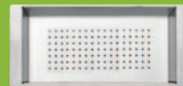

Ref. COL103
Stainless Steel Colander £120



Ref. COL105
Stainless Steel Colander £83



Ref. RM2000 Stainless Steel Draining Mat (round bar) £59
Ref. DR3000 Stainless Steel Draining Mat (square bar) £59



STEREO UNDERMOUNT/INSET



The **Stereo** sinks are state of the art, modern and very slick with 15mm radius corners and distinctive draining lines. These high quality sinks can be fitted in undermount and inset installations.

Manufactured from 1.0mm gauge stainless steel and coated with **SilentCote**® sound-proofing thermal paint on the underside (see page 97).



Stereo Single bowl
Ref. STE34 £315

Overall size: 370/430 mm
Bowl size: 340/400/200 mm
Minimum cabinet size: 400 mm

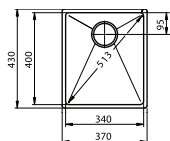

Stereo Single bowl
Ref. STE40 £360

Overall size: 430/430 mm
Bowl size: 400/400/200 mm
Minimum cabinet size: 500 mm

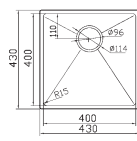

Stereo Single bowl
Ref. STE50 £400

Overall size: 530/430 mm
Bowl size: 500/400/200 mm
Minimum cabinet size: 600 mm

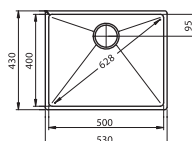



Stainless Steel



Stereo Single bowl

Ref. **STE65** £480

Overall size: 680/430 mm
 Bowl size: 650/400/230 mm
 Minimum cabinet size: 700 mm

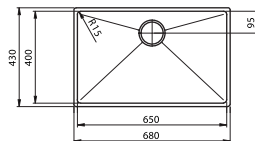

90mm Deco Strainer Wastes included with all Stereo sinks



Plumbing Kit included with multi-bowl sinks



Stereo Double bowl

Ref. **STE4034** £600

Overall size: 800/430 mm
 Left bowl: 340/400/200 mm
 Right bowl: 400/400/200 mm
 Minimum cabinet size: 850 mm

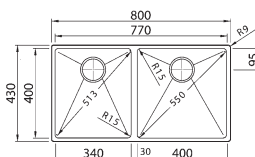

Deluxe Strainer Waste (upgrade)
 Chrome £20
 Brushed £32

Undermount Cutouts
 DXF drawings are available for download.



Ref. **RM2000** Stainless Steel Draining Mat (round bar) **£59**
 Ref. **DR3000** Stainless Steel Draining Mat (square bar) **£59**



Optional Accessories



Ref. **COL103**
 Stainless Steel Colander **£120**



Ref. **COL105**
 Stainless Steel Colander **£83**



STARK UNDERMOUNT



The **Stark** are a range of luxury sinks that have taken minimalism to new heights with their pure rectilinear lines. Durability is assured with 1.0mm gauge stainless steel coated with **SilentCote®** sound-proofing thermal paint on the underside (see page 97).

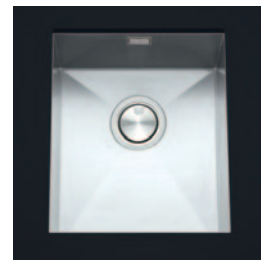

Stark Single bowl
Ref. SK34 £315

Overall size: 380/440 mm
 Bowl size: 340/400/200 mm
 Minimum cabinet size: 400 mm

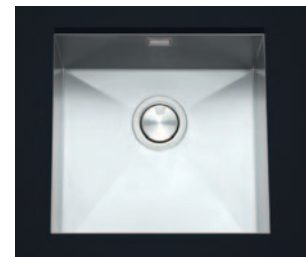
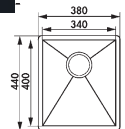

Stark Single bowl
Ref. SK40 £360

Overall size: 430/430 mm
 Bowl size: 400/400/200 mm
 Minimum cabinet size: 450 mm

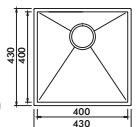



Stark 1.5 bowl shown with Zuben Stainless Steel Filter tap - see page 209

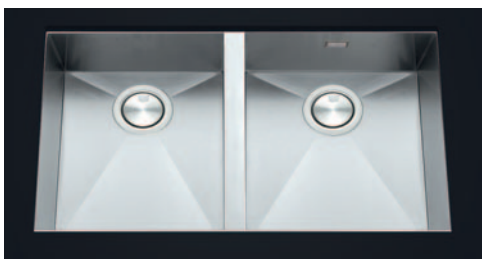

Stark Double bowl
Ref. SK77 £776

Overall size: 430/800 mm
Left bowl: 340/400/200 mm
Right bowl: 400/400/200 mm
Minimum cabinet size: 1000 mm

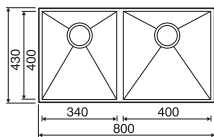

Stark 1.5 bowl
Ref. SK55 £500

Overall size: 580/430 mm
Main bowl: 340/400/200 mm
Half bowl: 180/400/140 mm
Min cabinet size: 600 mm

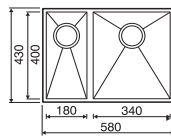

Stark Single bowl
Ref. SK50 £400

Overall size: 540/440 mm
Bowl size: 500/400/200 mm
Minimum cabinet size: 600 mm

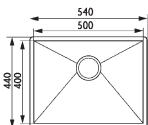

90mm Deco Strainer Wastes included with all Stereo sinks



Plumbing Kit included with multi-bowl sinks



Deluxe Strainer Waste (upgrade)
Chrome £20
Brushed £32

Undermount Cutouts
DXF drawings are available for download.



Icons Explained see page 96-97.



Stark Smart SKS006 shown as inset with Juno tap in Chrome - see page 228



Stark Smart Single bowl
Ref. SKS001 £419

Overall size: 440/490 mm
Bowl size: 380/400/220 mm
Cutout size: 420/470 mm (Inset)
Minimum cabinet size: 500 mm
Waste included: 90 mm BSW

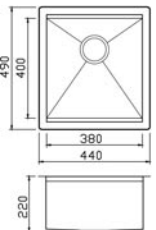

Stark Smart Single bowl
Ref. SKS002 £449

Overall size: 540/490 mm
Bowl size: 480/400/220 mm
Cutout size: 520/470 mm (Inset)
Minimum cabinet size: 600 mm
Waste included: 90 mm BSW

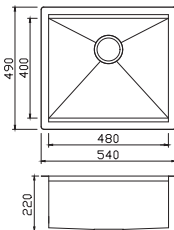

Stark Smart Single bowl
Ref. SKS003 £509

Overall size: 660/490 mm
Bowl size: 600/400/220 mm
Cutout size: 640/470 mm (Inset)
Minimum cabinet size: 700 mm
Waste included: 90 mm BSW

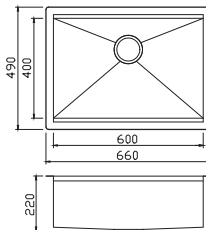

Stark Smart Single bowl
Ref. SKS004 £639

Overall size: 800/490 mm
Bowl size: 740/400/220 mm
Cutout size: 780/470 mm (Inset)
Minimum cabinet size: 1000 mm
Waste included: 90 mm BSW

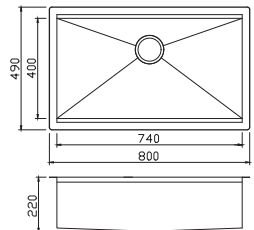



Stark Smart SKS005 shown as undermount with Jovian tap in Matt White - see page 235

ACCESSORIES Included



Ref. WBD426
Wooden Chopping Board

ACCESSORIES Optional



Ref. DB05
Stainless Steel Tray £46



Ref. COL105
Stainless Steel Colander £83



90mm Deco
Strainer Wastes
included with
all Stark sinks



Deluxe Strainer
Waste (upgrade)
Chrome £20
Brushed £32

**Undermount
Cutouts**
DXF drawings
are available
for download.



Stark Smart 1.5 bowl

Ref. SKS005 £519

Overall size: 600/490 mm
Bowl size: 360/400/220 mm
Half Bowl: 150/400/220 mm
Cutout size: 580/470 mm (Inset)
Minimum cabinet size: 700 mm
Wastes included: 2 x 90 mm BSW
& Plumbing Kit

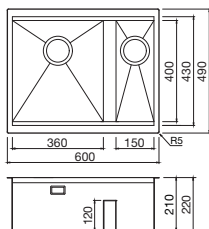

Stark Smart 1.5 bowl

Ref. SKS006 £649

Overall size: 740/490 mm
Bowl size: 500/400/220 mm
Half Bowl: 150/400/220 mm
Cutout size: 720/470 mm (Inset)
Minimum cabinet size: 800 mm
Wastes included: 2 x 90 mm BSW
& Plumbing Kit

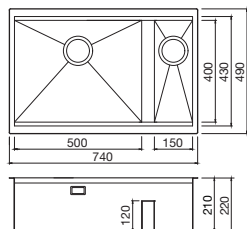

**STARK SMART
UNDERMOUNT/INSET**



The **Stark Smart** sinks have an ultra-contemporary style with zero radius bowls. They have been designed with the cook in mind with built-in accessory ledges which house custom-fit accessories. These include a wooden chopping board which is supplied with each sink and an optional strainer colander and strainer tray. These sit snugly on their ledges freeing up both hands for tasks such as rinsing vegetables and straining pasta.

The Smart accessories have transformed the Stark from a humble sink into a clever workstation.



Volta VL650S shown as undermount with Pioneer Pull-up tap in Brushed Nickel - see page 248



Volta Single bowl
Ref. VL185 £235

Overall size: 220/440 mm
Bowl size: 180/400/190 mm
Cutout size: 200/420 mm (Inset)
Minimum cabinet size: 300 mm
Waste included: 90 mm BSW

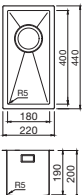

Volta Single bowl
Ref. VL400S £300

Overall size: 440/440 mm
Bowl size: 400/400/190 mm
Cutout size: 420/420 mm (Inset)
Minimum cabinet size: 500 mm
Waste included: 90 mm BSW

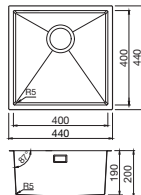

Volta Single bowl
Ref. VL500S £335

Overall size: 540/440 mm
Bowl size: 500/400/190 mm
Cutout size: 520/420 mm (Inset)
Minimum cabinet size: 600 mm
Waste included: 90 mm BSW

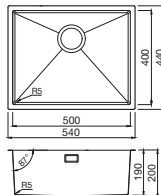

Volta Single bowl
Ref. VL650S £390

Overall size: 690/440 mm
Bowl size: 650/400/190 mm
Cutout size: 670/420 mm (Inset)
Minimum cabinet size: 800 mm
Waste included: 90 mm BSW

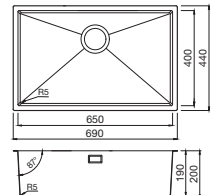



Volta VL53LS shown as undermount with Karuma Pull-out tap in Brushed Nickel - see page 246



Volta 1.5 bowl

Ref. VL53LS LH Main Bowl **£535**

Ref. VL53RS RH Main Bowl **£535**

Overall size: 575/450 mm
Bowl size: 340/400/190 mm
Half bowl: 180/400/190 mm
Cutout size: 555/430 mm (Inset)
Minimum cabinet size: 600 mm
Wastes included: 2 x 90 mm BSW
& Plumbing Kit

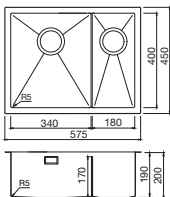

Volta 1.5 bowl

Ref. VL68LS LH Main Bowl **£605**

Ref. VL68RS RH Main Bowl **£605**

Overall size: 735/450 mm
Bowl size: 500/400/190 mm
Half bowl: 180/400/190 mm
Cutout size: 715/430 mm (Inset)
Minimum cabinet size: 800 mm
Wastes included: 2 x 90 mm BSW
& Plumbing Kit

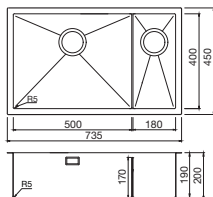

VOLTA UNDERMOUNT/INSET



The **Volta** has fine radius corners and smart draining lines creating a very modern statement. There are six options to choose from, including two versatile 1.5 bowl models which feature a unique slim bowl divider reinforcing the Volta's sophisticated design.

The Volta is manufactured in 1.0 thick steel which has been treated with **SilentCote**® to enhance its robust qualities and provide hushed tones when in use.

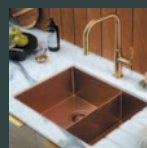

See the PVD Voltas
on pages 140-141



Deluxe Strainer Waste (upgrade)
Chrome **£20**
Brushed **£32**



90mm Deco Strainer Waste
included with
all sinks



Plumbing Kit
included with
multi-bowl sinks

Undermount Cutouts

DXF drawings are
available for
download



Volta VL650DBB shown as undermount with Rococo Twist & Spray tap in Artisan Brass - see page 224

Dura Finish

A unique random brushed effect providing a rich patina that disguises scratches.

This prolongs its original looks beyond other finishes.

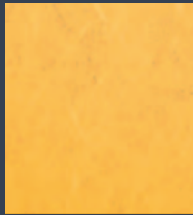

Brass



Copper

Volta PVD Properties

- Higher resistance to scratches and abrasions.
- Higher corrosion resistance.
- High resistance to domestic chemicals and cleaners.
- Hygienic surface – suitable for food contact.
- Enhanced decorative finish.



Volta Single bowl
Ref. VL400DBB £435

Overall size: 440/440 mm
Bowl size: 400/400/190 mm
Cutout size: 420/420 mm (Inset)
Minimum cabinet size: 500 mm
Waste included: 90 mm BSW

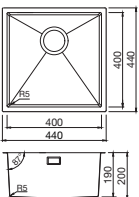

Volta Single bowl
Ref. VL500DBB £485

Overall size: 540/440 mm
Bowl size: 500/400/190 mm
Cutout size: 520/420 mm (Inset)
Minimum cabinet size: 600 mm
Waste included: 90 mm BSW

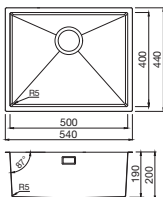

Volta Single bowl
Ref. VL650DBB £540

Overall size: 690/440 mm
Bowl size: 650/400/190 mm
Cutout size: 670/420 mm (Inset)
Minimum cabinet size: 800 mm
Waste included: 90 mm BSW

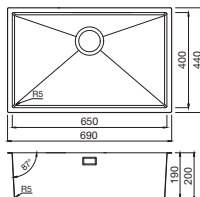

Volta 1.5 bowl
Ref. VL53LDBB LH Main Bowl £655
Ref. VL53RDBB RH Main Bowl £655

Overall size: 575/450 mm
Bowl size: 340/400/190 mm
Half bowl: 180/400/190 mm
Cutout size: 555/430 mm (Inset)
Minimum cabinet size: 600 mm
Wastes included: 2 x 90 mm BSW & Plumbing Kit

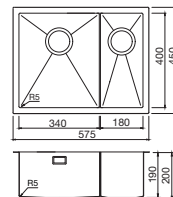



Volta VL53LDBC shown as undermount with Pioneer Pull-out tap in Brushed Brass - see page 248



Stainless Steel

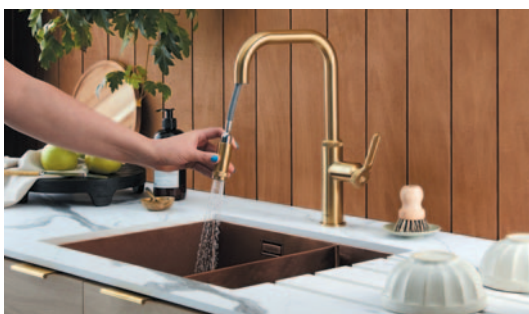

VOLTA PVD UNDERMOUNT/INSET



The **Volta PVD** range is our latest elegant range of bowls that can be fitted in both under-mount and inset applications. The bowls have crisp 5mm radius corners and stylish pressed draining-lines. They are all available in Brass, Bronze and a very chic Black finish (see over page). These special finishes are created using a PVD process that provides an extremely resilient surface. The Dura-Brushed finish is a unique random brushed effect, providing a rich patina that disguises scratches and prolongs its original looks.

The Volta 1.5 model features a slick, ultra-slim bowl divider that maximises the bowls capacity whilst retaining an overall compact dimension, ensuring that it fits into 60cm wide cabinetry.

All models have been constructed in 1.0 mm stainless steel and coated with **SilentCote®** on the underside for increased sound-proofing.



Plumbing Kit included with multi-bowl sinks

Undermount Cutouts DXF drawings are available for download



Icons Explained see page 96-97.



Volta Single bowl
Ref. **VL500DBC** £485

Overall size: 540/440 mm
Bowl size: 500/400/190 mm
Cutout size: 520/420 mm (Inset)
Minimum cabinet size: 600 mm
Waste included: 90 mm BSW

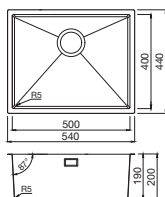

Volta 1.5 bowl
Ref. **VL53LDBC** £655
Ref. **VL53RDBC** £655

Overall size: 575/450 mm
Bowl size: 340/400/190 mm
Half bowl: 180/400/190 mm
Cutout size: 555/430 mm (Inset)
Minimum cabinet size: 600 mm
Wastes included: 2 x 90 mm BSW & Plumbing Kit

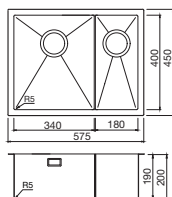



Volta VL53LBL shown as undermount with Morpho Matt Black tap with flex and stay spout - see page 232-233



Volta 1.5 bowl
Ref. VL53LBL £700

Overall size: 575/450 mm
Bowl size: 340/400/190 mm
Half bowl: 180/400/190 mm
Cutout size: 555/430 mm (Inset)
Minimum cabinet size: 600 mm
Wastes included: 2 x 90 mm BSW & Plumbing Kit

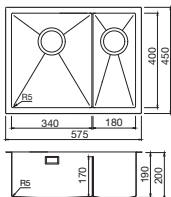

Volta 1.5 bowl
Ref. VL53RBL £700

Overall size: 575/450 mm
Bowl size: 340/400/190 mm
Half bowl: 180/400/190 mm
Cutout size: 555/430 mm (Inset)
Minimum cabinet size: 600 mm
Wastes included: 2 x 90 mm BSW & Plumbing Kit

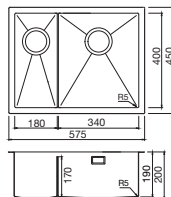

NANO COATING

Nano Coating is the process of applying an ultra-thin surface layer which gives the product a mechanically flat surface. Which repels dry particles, water, oil, and dirt. Resulting in a product that is dirt repellent and more hygienic, easier to clean and more resistant to scratches and chemicals. Other benefits include a reduction in grease and finger marks.



Properties

- Dirt Repellent and Hygienic
- Hydrophobic
- Chemical Resistance
- Ultraviolet Resistance
- Reduces Grease and Finger Marks



Stainless Steel

Volta VL650BL shown as undermount with Tutti Twist & Spray tap in Matt Black - see page 225

VOLTA PVD UNDERMOUNT/INSET



The **Volta PVD Black** is black - not compromised tones of dark grey that is usually on offer. This pure colour creates a very sophisticated presence in the kitchen and is certainly statement making. The PVD properties add a very resistant surface and the Volta Black has also been treated with Nano technology. This has created a uniquely smooth surface which is not only dirt repellent but is extremely hygienic.

These sleek sinks are fabricated in 1.0 steel and have been treated with **SilentCote®** to increase the robustness and add hushed tones when in use.

The 1.5 bowl model has a very slim bowl divider adding a very contemporary aesthetic whilst maximising the bowl dimensions.



Volta Single bowl
Ref. **VL400BL** £450

Overall size: 440/440 mm
Bowl size: 400/400/190 mm
Cutout size: 420/420 mm (Inset)
Minimum cabinet size: 500 mm
Waste included: 90 mm BSW

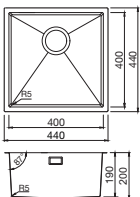

Volta Single bowl
Ref. **VL500BL** £490

Overall size: 540/440 mm
Bowl size: 500/400/190 mm
Cutout size: 520/420 mm (Inset)
Minimum cabinet size: 600 mm
Waste included: 90 mm BSW

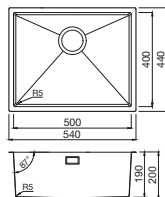

Volta Single bowl
Ref. **VL650BL** £550

Overall size: 690/440 mm
Bowl size: 650/400/190 mm
Cutout size: 670/420 mm (Inset)
Minimum cabinet size: 800 mm
Waste included: 90 mm BSW

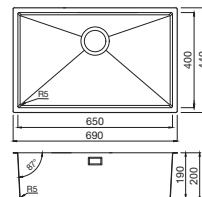

Plumbing Kit included with multi-bowl sinks

Undermount Cutouts
DXF drawings are available for download.



Icons Explained see page 96-97



Salsa SA45BB shown as undermount with Loreto tap in Brushed Brass - see page 234

Satin Finish

A very fine brushed swirled effect.

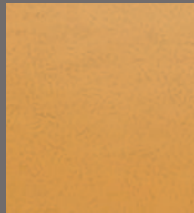

Brass

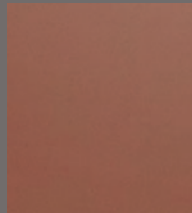

Copper

Salsa PVD Properties

- Higher resistance to scratches and abrasions.
- Higher corrosion resistance.
- High resistance to domestic chemicals and cleaners.
- Hygienic surface – suitable for food contact.
- Enhanced decorative finish.

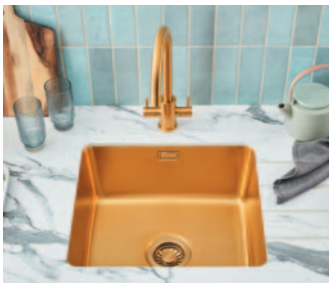

Salsa Single bowl
Ref. SA35BB £335

Overall size: 390/440 mm
Bowl size: 350/400/195 mm
Minimum cabinet size: 400 mm
Wastes included: 90 mm BSW



Salsa Single bowl
Ref. SA45BB £400

Overall size: 490/440 mm
Bowl size: 450/400/195 mm
Minimum cabinet size: 500 mm
Wastes included: 90 mm BSW



Salsa 1.5 bowl (Undermount only)
Ref. SA55LBB £520

Overall size: 600/440 mm
Bowl size: 350/400/195 mm
Half bowl: 180/300/98 mm
Minimum cabinet size: 600 mm
Wastes included: 2 x 90 mm BSW & Plumbing Kit

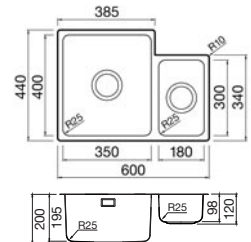
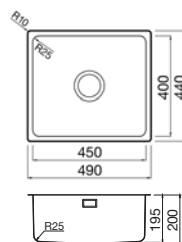
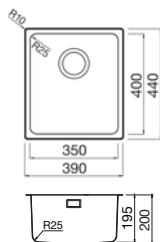



Salsa SA55LRC shown as undermount with Rococo Twist & Spray tap in Regency Copper - see page 224

Stainless Steel

SALSA PVD UNDERMOUNT/INSET



The **PVD Salsa** undermount/inset bowl collection are our most economical range of PVD sinks. Choose from two single bowl size options or a versatile 1.5 model. The Brass or Copper colour choices add a warm glamorous effect and the durable PVD qualities provide a higher level of scratch and abrasion resistance. The **SilentCote®** sound proofing compound has also been applied to the underside for added hushed tones.



Plumbing Kit included with multi-bowl sinks

Undermount Cutouts DXF drawings are available for download



Salsa 1.5 bowl (Undermount only)
Ref. SA55LRC £520

Overall size: 600/440 mm
Bowl size: 350/400/195 mm
Half bowl: 180/300/98 mm
Minimum cabinet size: 600 mm
Wastes included: 2 x 90 mm BSW & Plumbing Kit

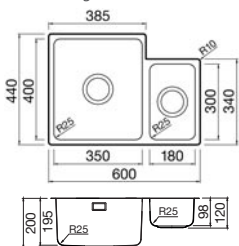

Salsa Single bowl
Ref. SA45RC £400

Overall size: 490/440 mm
Bowl size: 450/400/195 mm
Minimum cabinet size: 500 mm
Wastes included: 90 mm BSW

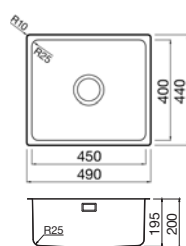

Salsa Single bowl
Ref. SA35RC £335

Overall size: 390/440 mm
Bowl size: 350/400/195 mm
Minimum cabinet size: 400 mm
Wastes included: 90 mm BSW

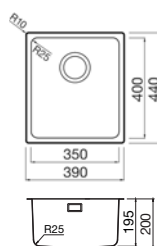

APRON FRONTED

Our stainless steel Apron Fronted range consists of the ever popular **Belfast** shown on this page and the fabulous double bowl **Infinity Smart** which uses an integrated ledge to incorporate a range of useful accessories.



In this installation the sink is fitted directly onto a cabinet with its front fascia exposed.

This type of installation is only suitable for solid surface worktops such as Granite, Marble or Wood.



Belfast shown with Titania TI2SS Stainless Steel tap - see page 258



Stainless Steel

Belfast shown with Rosetta Filter tap in Brushed Nickel - see page 196



Belfast Single bowl
Ref. INR001 £563

Overall size: 600/465 mm
 Bowl size: 530/395/229 mm
 Waste included: 90 mm BSW

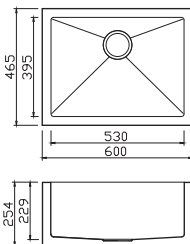

BELFAST



This fabulous incarnation of the traditional ceramic Butler sink transports an old classic to the 21st century with great style.

The **Belfast** has lost none of the capacious dimensions of its ceramic cousin and is an ideal choice for the cook's kitchen as it can take on the largest pans and trays with ease.





**ACCESSORIES
Included**



Ref. WBD426
Wooden Chopping Board



Ref. DB05
Stainless Steel Tray

**ACCESSORIES
Optional**



Ref. DB03
Stainless Steel Plate Rack £40
(fits within the DB05 Tray)



Ref. COL105
Stainless Steel Colander £83

Infinity Smart INS002 shown with sliding chopping board



Infinity Smart Single bowl

Ref. INS001 £668

Overall size: 600/510 mm
Bowl size: 530/400/229 mm
Waste included: 90 mm BSW

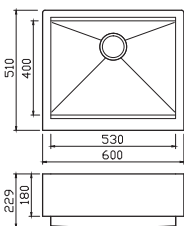

Infinity Smart Single bowl

Ref. INS002 £750

Overall size: 800/510 mm
Bowl size: 730/400/229 mm
Waste included: 90 mm BSW

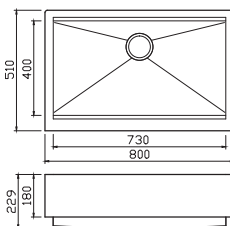

Infinity Smart 1.5 bowl

Ref. INS003 £863

Overall size: 800/510 mm
Bowl size: 426/400/229 mm
Half bowl: 264/400/229 mm
Waste included: 2 x 90 mm BSW
& Plumbing Kit

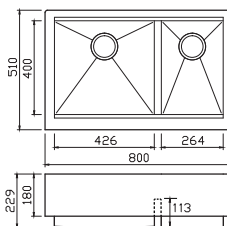







Stainless Steel

Infinity Smart INS002 shown with Magus 3 Kettle tap in Brushed Nickel - see page 176 -177



Infinity INS003 showing the low partition flood wall

INFINITY SMART







The **Infinity Smart** Butler sinks create a lustrous focal point in the kitchen, the architectural aesthetics are enhanced by the slender front apron which disguises the true depth of these sinks adding to their sophisticated appearance.

All models have a unique integrated ledge to accommodate an essential range of accessories that maximize the Infinity Smart's abilities.

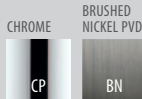
Please note the 1.5 bowl model has low partition wall which allows both bowls to be flooded to create a larger washing area.

GRANITE SINK + TAP PACKS SAVE 10%



VITRO PAGE 240



TUTTI PAGE 225



ZODIAC PAGE 221

POLAR	ONYX	MOONSTONE	NERO	CROMA	CONCRETE	POPPY	BASALT	MOCHA
PO	ON	MS	NE	CR	CN	PP	BA	MC

Tivoli Single Bowl Ref. TIV D 100L



** Insert colour code to pack reference

Page 22

VITRO PACK

CP TIV**1VIT CP **£388**

BN TIV**1VIT BN **£397**

TUTTI PACK

TIV**1TUT CP **£486**

TIV**1TUT BN **£502**

ZODIAC PACK

TIV**1ZO2 CP **£422**

TIV**1ZO2 BN **£437**

Tivoli 1.5 Bowl Ref. TIV D 150



** Insert colour code to pack reference

Page 22

VITRO PACK

CP TIV**15VIT CP **£388**

BN TIV**15VIT BN **£397**

TUTTI PACK

TIV**15TUT CP **£486**

TIV**15TUT BN **£502**

ZODIAC PACK

TIV**15ZO2 CP **£422**

TIV**15ZO2 BN **£437**

Rio Single Bowl Ref. RIO D 100L



** Insert colour code to pack reference

Page 24

VITRO PACK

CP RIO**1VIT CP **£388**

BN RIO**1VIT BN **£397**

TUTTI PACK

RIO**1TUT CP **£486**

RIO**1TUT BN **£502**

ZODIAC PACK

RIO**1ZO2 CP **£422**

RIO**1ZO2 BN **£437**

Rio 1.5 Bowl Ref. RIO D 150

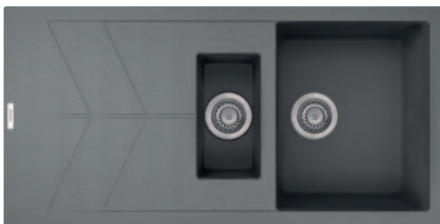

** Insert colour code to pack reference

Page 24

VITRO PACK

CP RIO**15VIT CP **£388**

BN RIO**15VIT BN **£397**

TUTTI PACK

RIO**15TUT CP **£486**

RIO**15TUT BN **£502**

ZODIAC PACK

RIO**15ZO2 CP **£422**

RIO**15ZO2 BN **£437**

STAINLESS STEEL SINK + TAP PACKS SAVE 10%



VITRO PAGE 240



TUTTI PAGE 225



ZODIAC PAGE 221

Bolero Single Bowl Ref. BO100

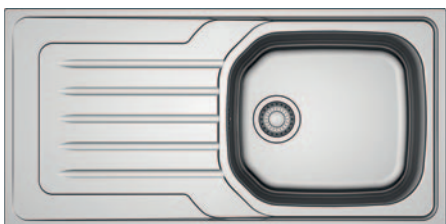

Page 101

	VITRO PACK	TUTTI PACK	ZODIAC PACK
CP	BO10VIT CP £251	BO10TUT CP £349	BO10ZO2 CP £285
BN	BO10VIT BN £260	BO10TUT BN £365	BO10ZO2 BN £300

Bolero 1.5 Bowl Ref. BO150

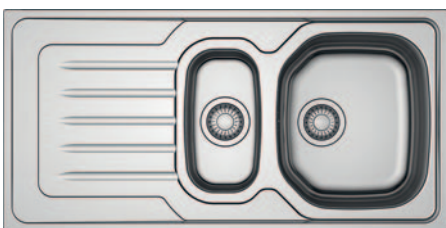

Page 101

	VITRO PACK	TUTTI PACK	ZODIAC PACK
CP	BO15VIT CP £301	BO15TUT CP £399	BO15ZO2 CP £335
BN	BO15VIT BN £310	BO15TUT BN £415	BO15ZO2 BN £349

Starline Single Bowl Ref. SL100

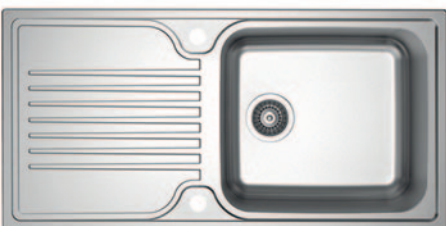

Page 99

	VITRO PACK	TUTTI PACK	ZODIAC PACK
CP	SL10VIT CP £285	SL10TUT CP £383	SL10ZO2 CP £320
BN	SL10VIT BN £294	SL10TUT BN £400	SL10ZO2 BN £334

Starline 1.5 Bowl Ref. SL150



Page 99

	VITRO PACK	TUTTI PACK	ZODIAC PACK
CP	SL15VIT CP £303	SL15TUT CP £401	SL15ZO2 CP £338
BN	SL15VIT BN £312	SL15TUT BN £418	SL15ZO2 BN £352

Waste Disposers

Cleaner, more convenient and environmentally responsible

Fast becoming the must-have sink appliance for today's modern kitchen. At the touch of a button, food waste is dealt with hygienically and instantly - rather than leaving it in the bin to encourage smells, bacteria and insects.

Waste disposers don't just offer practical convenience, they provide an environmentally sound answer to the growing problem of food waste.

www.insinkerator.co.uk

STANDARD & PREMIUM

Lift & Latch Technology makes it easy to install into new or existing kitchens and can be fitted to most sinks.

- Continuous feed operation
- Air switch included
- Grind chamber capacity 980ml



Standard Model 460
Ref. S460 SR-1 A/S £249

- Space-Saving compact design
- Single stage grind
- Up to 3 year limited warranty
- 0.55hp

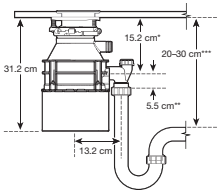

Premium Model 550 SR
Ref. P550 SR-1 A/S £347

- 2-Stage MultiGrind Technology
- Up to 5 year limited warranty
- 0.55hp

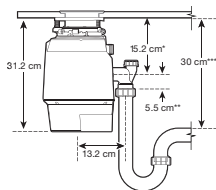

Premium Model 700 SR
Ref. P700 SR-1 A/S £551

- 2-Stage MultiGrind Technology
- Up to 6 year limited warranty
- 0.75hp

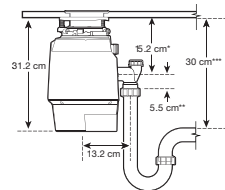

ACCESSORIES



Batch Feed Kit
Batch feed conversion for Premium 700 and Evolution 750 & 1000.
Ref. 77549 £127

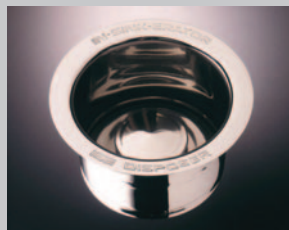

Extended Flange
Continuous feed models only. For use with sinks with a greater than 20mm thickness, Stainless Steel finish **Ref. 10082 £41**



Plumbing Kits
Universal Plumbing Kit **Ref. 71498 £28**
Dishwasher Connection Kit **Ref. 08301 £30**



ADVANCED SERIES

- Lift & Latch Technology makes it easy to install into new or existing kitchens and can be fitted to most sinks.
- Continuous feed operation
- Air switch included
- Grind chamber capacity 980ml



Evolution Plus Model 750 SR
Ref. E750 SR-1 A/S £671

- Quiet SoundSeal Technology
- Removable Antimicrobial Baffle
- 3-Stage MultiGrind Technology
- Advanced Grind
- Up to 7 year limited warranty
- 0.75hp

Evolution Plus Model 1000 SR
Ref. E1000 SR-1 A/S £805

- Quietest SoundSeal Technology our quietest disposal on the market
- Removable Antimicrobial Baffle
- 4-Stage MultiGrind Technology
- Advanced Grind
- Up to 8 year limited warranty
- 1hp

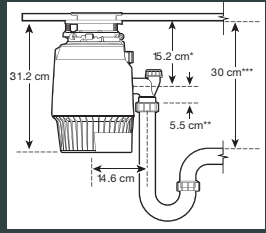
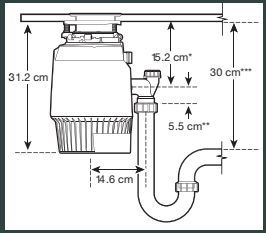

Accessories

ISE Kettle and Filter Taps



see page 184-187

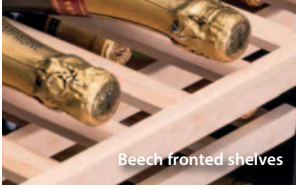

Beech fronted shelves



Square handles



White LED Touch controls



WINE CABINETS UNDER COUNTER

Caple's wine cabinets create the optimum storage conditions for your wine; the correct temperature, humidity and air circulation. They even use low vibration technology to minimise disturbance.

This new range of wine cabinets feature the new square handle, white LED Touch controls and beech fronted shelves.

WIDTH 145 - 1 ZONE 5°C - 18°C - G ENERGY



Ref. Wi158BG £420
Black Glass



Ref. Wi159 £380
Stainless Steel

WIDTH 295 - 1 ZONE 5°C - 18°C - F ENERGY



Ref. Wi3126 £740
Black Glass



Ref. Wi3125 £622
Stainless Steel



Ref. Wi3125GM £694
Gun Metal

WIDTH 595 - 1 ZONE 5°C - 18°C - G ENERGY



Ref. Wi6143BG £1065
Black Glass



Ref. Wi6142 £980
Stainless Steel

WIDTH 595 - 2 SIDE-BY-SIDE ZONES 5°C - 10°C & 10°C - 18°C - G ENERGY



Ref. Wi6235BG £1514
Black Glass



Ref. Wi6234 £1370
Stainless Steel

WIDTH 595 - 2 ZONE 5°C - 10°C & 10°C - 18°C - G ENERGY



Ref. Wi6136 £1228
Black Glass



Ref. Wi6135 £1169
Stainless Steel



Ref. Wi6135 GM £1254
Gun Metal

SPECIFICATIONS

Telescopic Shelves

The beech and stainless steel fronted telescopic wire shelves are gentle on the bottles, reducing any accidental scratches on the label and allowing you to easily view your collection.

Perfect for Burgundy, Bordeaux and Champagne bottles.

Air Purifying Technology

Charcoal filters eliminate odours and impurities in the air, preventing them from penetrating the cork, to ensure your collection is at its best when it comes to serving.

Premium Functionality

Four light settings and four functions means you can find the right storage environment to suit your wine.



PREMIUM WINE CABINETS UNDER COUNTER



WIDTH 295 - 1 ZONE 5°C - 18°C - F ENERGY



Ref. Wi3150
£807
Stainless Steel



Ref. Wi3155BG
£840
Black Glass

WIDTH 595 - 2 ZONE 5°C - 10°C & 10°C - 18°C - F ENERGY



Ref. Wi6150 £1351
Stainless Steel



Ref. Wi6155BG £1401
Black Glass



Ref. Wi6161 £1530
The wood surround versions are integrated and a bespoke kitchen door can be facia fitted to match surrounding units.

WINE CABINETS IN-COLUMN



Ref. WC6521BG £1438
Sense in-column wine cabinet

Height 886mm
G energy
Black glass door
2 zones 5°C -10°C and 10°C -18°C
Square handle
Touch control
White LED lighting



Ref. WC6511 £1438
Classic in-column wine cabinet

Height 886mm
G energy
1 piece stainless steel door
2 zones 5°C -10°C and 10°C -18°C
Square handle
Touch control
White LED lighting



Ref. WC6411BG £1047
Sense in-column wine cabinet

Height 455mm
F energy
Black glass door
Single zone 5°C -18°C
Square handles
Touch control
White LED lighting



Ref. WC6401 £967
Classic in-column wine cabinet

Height 455mm
F energy
1 piece stainless steel door
Single zone 5°C -18°C
Square handles
Touch control
White LED lighting

90 mm Strainer Wastes

WASTE ONLY

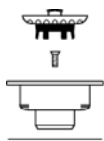

Stainless Steel
Ref. W90C £24



Brushed Steel
with hinged cover
Ref. W90SC £24

PVD & NANO COATED



Matt Black
Ref. W90MB £53

PVD COATED



Gold
Ref. W90G £53



Artisan Brass
Ref. W90AB £53

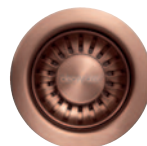

Regency Copper
Ref. W90RC £53

WASTE WITH OVERFLOW



Stainless Steel
Ref. W90OC £30



Brushed Steel
with hinged cover
Ref. W90OSC £30

PVD & NANO COATED



Matt Black
Ref. W90OMB £69

PVD COATED



Gold
Ref. W90OG £69



Artisan Brass
Ref. W90OAB £69



Regency Copper
Ref. W90ORC £69

PVD coated wastes can only be supplied with B or C overflows.

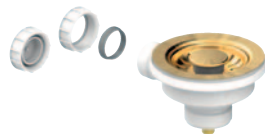

60 mm Strainer Wastes

70mm FLANGE



Stainless Steel
Ref. W60C £27



Brushed Steel
Ref. W60BS £37



Matt Black
Ref. W60MB £37



Artisan Brass
Ref. W60AB £43



Regency Copper
Ref. W60RC £43

PVD COATED

85mm FLANGE



Stainless Steel
Ref. WRPC £30

PVD COATED



Gold
Ref. WRPG £47



Artisan Brass
Ref. WRPAB £47



Regency Copper
Ref. WRPRC £47

90 mm Deluxe Strainer Wastes



Chrome
Ref. **DWC** £37
Brushed Steel
Ref. **DWB** £40

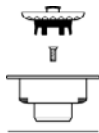

Chrome
Ref. **DWOC** £39
Brushed Steel
Ref. **DWOB** £42



Thomas Denby Waste Kits

Prices apply to wastes with or without overflows

Please state type required



Single Bowl Kit
TD1WC
Chrome £61
Double Bowl Kit
TD2WC
Chrome £113



Single Bowl Kit
TD1WBS
Brushed Steel £68
Double Bowl Kit
TD2WBS
Brushed Steel £129



Single Bowl Kit
TD1WBB
Brushed Brass PVD £106
Double Bowl Kit
TD2WBB
Brushed Brass PVD £190



Single Bowl Kit
TD1WRC
Regency Copper PVD £106
Double Bowl Kit
TD2WRC
Regency Copper PVD £190



Single Bowl Kit
TD1WBR
Bronze PVD £106
Double Bowl Kit
TD2WBR
Bronze PVD £190



Single Bowl Kit
TD1WNI
Polished Nickel PVD £106
Double Bowl Kit
TD2WNI
Polished Nickel PVD £190

OVERFLOWS

Add A, B, C, D or E
as suffix to waste code

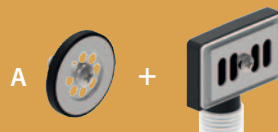

Type A includes both round and rectangular plate

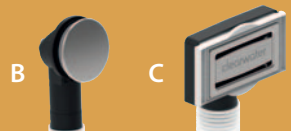

Round Plate



Rectangular Plate

Thomas Denby



Round Plate



Rectangular Plate

Wastes



PRESTO Automatic Wastes

The **Presto** uses the latest technology for waste control; it only takes a light press of the control button to open and close the waste - no more struggling to twist a control switch with wet hands.

Presto Pop-Up Waste Ref. **WP10**

Chrome £44
Brushed Steel £44
Artisan Brass £114
Regency Copper £114
Matt Black £75



Contract Wastes

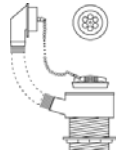

1.5" Waste & Overflow
Ref. **WCWO** Chrome: £7



1.5" Belfast Slotted Waste (weir overflow)
Ref. **WBESC** Chrome: £33

Plumbing Kits

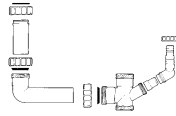

Plumbing Kit for 1.5 bowl
Ref. **WPK15** £17

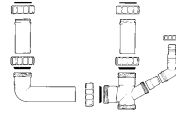

Plumbing Kit for 2 bowl
Ref. **DMPK2** £17

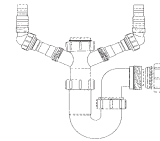

Sink Waste Trap
Ref. **WST** £22

Space Saver Plumbing Kits

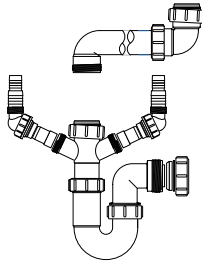

Space Saver Plumbing Kit for single bowl
Ref. **SSK1** £27

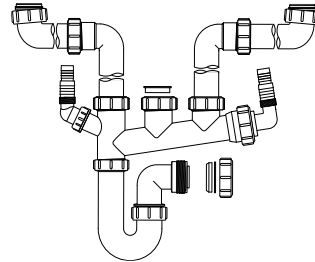

Space Saver Plumbing Kit for 1.5 and double bowl
Ref. **SSK2** £47

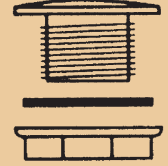

Top Hole Covers

Ref. **THP**
Polished: £3

Ref. **THL**
Linen: £3

Ref. **THB**
Brushed: £3

Ref. **ASP2058**
Ceramic: £7

Replacement Filter Cartridges



Pure Filter Tap Filter
Ref. **P6C1** £55

Each filter delivers 3800 litres of filtered water at a fraction of the price of bottled water.

Filtered water untainted by the taste of heavy metals, limescale and chlorine results in fresh, great tasting water straight from the tap.

WRAS Approved



Magus, Hotshot & Longdon Kettle Filter (6 month)
Ref. **F6C1** £72

This filter has a 6 month life span and a capacity of 3800 litres.

Filtered water is untainted by the taste of heavy metals, limescale and chlorine.

NSF REG4 Approved



Magus, Hotshot & Longdon Kettle Filter (12 month)
Ref. **F12C1** £112

This filter has a 12 month life span and a capacity of 7600 litres.

Filtered water is untainted by the taste of heavy metals, limescale and chlorine.

WRAS Approved

Plate Racks & Drainers

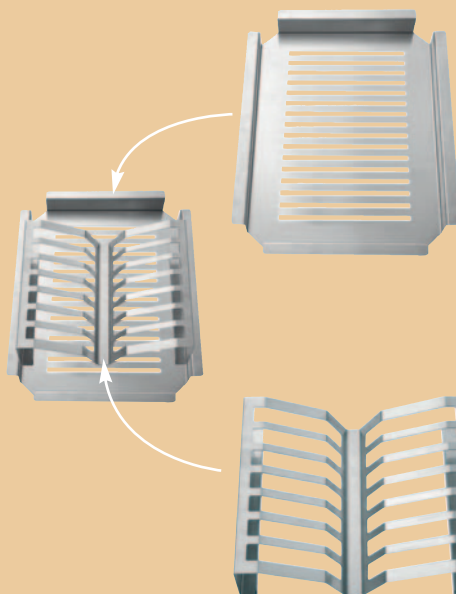

Stainless Steel Bowl Drainer
Ref. DB05 £46

Fits any sink with a 400mm bowl dimension.

Stainless Steel Plate Rack
Ref. DB03 £40

Free standing on the sink, worktop or drainer.

Stainless Steel Draining Mats

Fits over the sink creating extra drainable preparation area.

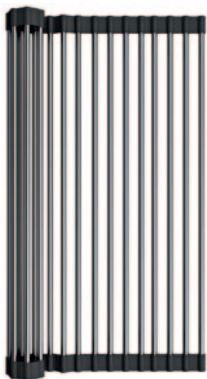

Ref. RM2000 (round bar) £59

Ref. DR3000 (square bar) £59

Size 300mm x 430mm

Ref. DR3400 (square bar) £59

Size 360mm x 340mm



Round Bar



Square Bar



Colanders, Trays & Chopping Boards

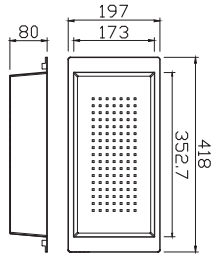

Stainless Steel Colander
Ref. COL103 £120

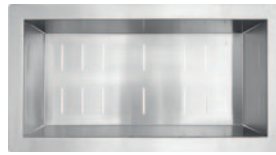

Stainless Steel Colander
Ref. COL108 £80

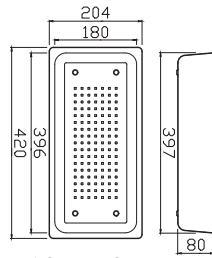
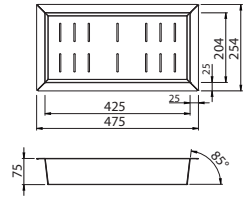

Stainless Steel Colander
Ref. COL105 £83

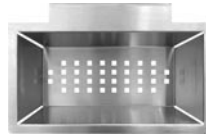

Stainless Steel Colander
Ref. COL106 £70



Stainless Steel Colander
Ref. COL107 £70

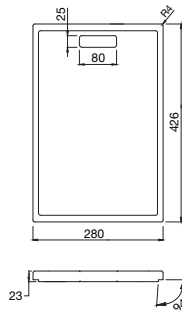
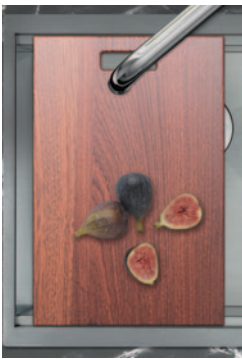
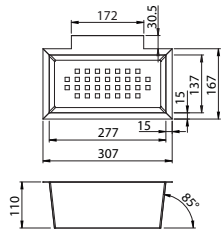
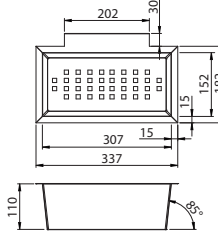

Wooden Chopping Board
Ref. WBD426 £37



Stainless Steel Colander
Ref. COL415 £120



Stainless Steel Colander
Ref. COL101 £120

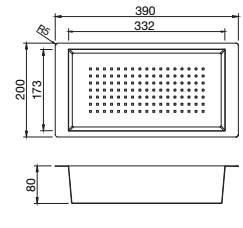
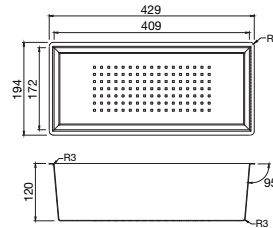

Wooden Chopping Board
Ref. WBD433 £37

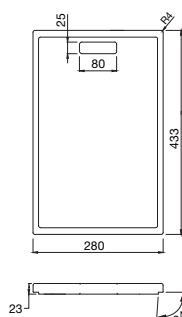

Stainless Steel Tray
Ref. TR415 £46



Stainless Steel Tray
Ref. DB04 £46

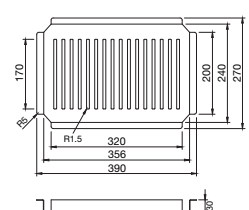
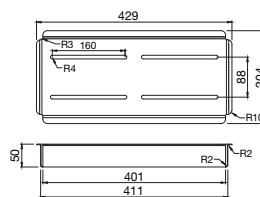

LINEA

Waste Sorter Bins

Now waste recycling has become mandatory a waste bin system that offers versatility whilst fitting neatly in to standard kitchen units is here in the shape of the Linea. There are 4 models to choose from with single and multi material bins in various sizes so there should be the right one for most peoples lifestyles.

Ref. 2A1100 Linea 130 £116

Material: Casing ABS - Bins polypropylene
 Minimum cabinet size: 300mm
 Minimal Installation dimension: H 433mm W 253mm D 467mm
 Bin size: 1 x 30 litre
 Operation: Manual - front pull-out
 With runners & ball bearings
 Fixed lid
 Warranty: 2 years
 Conforms to the code for sustainable homes - 4 credits

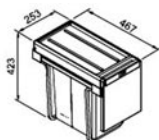

Ref. 2A1101 Linea 330 £116

Material: Casing ABS - Bins polypropylene
 Minimum cabinet size: 300mm
 Minimal Installation dimension: H 433mm W 253mm D 467mm
 Bin size: 3 x 10 litre
 Operation: Manual - front pull-out
 With runners & ball bearings
 Fixed lid
 Warranty: 2 years
 Conforms to the code for sustainable homes - 4 credits

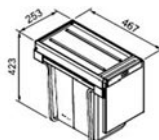

Ref. 2A1103 Linea 332 £155

Suitable to fit under a sink bowl
 Material: Casing ABS - Bins polypropylene
 Minimum cabinet size: 500mm
 Minimal Installation dimension: H 340mm W 438mm D 330mm
 Bin size: 1 x 16 litre, 2 x 8 litre
 Operation: Manual - front pull-out
 With runners & ball bearings
 Fixed lid
 Warranty: 2 years
 Conforms to the code for sustainable homes - 4 credits

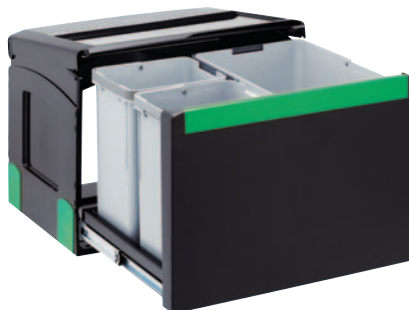
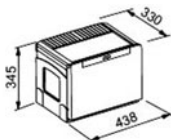

Ref. 2A1102 Linea 360 £241

Material: Casing ABS - Bins polypropylene
 Minimum cabinet size: 600mm
 Minimal Installation dimension: H 433mm W 510mm D 467mm
 Bin size: 1 x 30 litre, 2 x 15 litre
 Operation: Manual - front pull-out
 With runners & ball bearings
 Fixed lid
 Warranty: 2 years
 Conforms to the code for sustainable homes - 2 credits

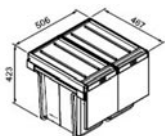

BOXED QUANTITIES

- Shell 6055 Shell drawer handle (5 boxed)
- Rounded 6060 Large rounded drawer handle (5 boxed)
- Contour 6070 Large contour drawer handle (5 boxed)
- Button 6080 Large button drawer handle (5 boxed)
- Concave 6090 Large concave drawer handle (5 boxed)

FURNITURE HANDLES

A selection of handles and pulls available in standard and special finishes, designed to give a consistent and luxurious look across your kitchen brassware and overall design.

All handles are colour coordinated with the Perrin & Rowe tap collection see pages 188 -189, 210 - 213, 280 - 283 & 312 - 319.



Contour 6070BR



Shell 6055BR



Shell **6055**

The **Shell** handle adds retro authenticity that is perfectly suited to Shaker style kitchens. The ergonomic shape is also ideal for pulling out heavy cutlery drawers.

(Boxed 5)

Chrome Ref. 6055CP **£189**

Nickel Ref. 6055NI **£208**

Pewter Ref. 6055PF **£227**

Special finishes allow 10-12 weeks delivery

English Bronze Ref. 6055BZ **£237**

Gold Ref. 6055IG **£256**

Polished Brass Ref. 6055BR **£256**

Satin Brass Ref. 6055SB **£256**

Aged Brass 6055AB **£256**

Standard Finishes



Chrome CP



Polished Nickel NI



Pewter PF



Rounded **6060**

The **Rounded** handle has a classic style that adds a timeless elegance to the kitchen space.

(Boxed 5)

Chrome Ref. 6060CP **£288**

Nickel Ref. 6060NI **£318**

Pewter Ref. 6060PF **£346**

Special finishes allow 10-12 weeks delivery

English Bronze Ref. 6060BZ **£361**

Gold Ref. 6060IG **£389**

Polished Brass Ref. 6060BR **£389**

Satin Brass Ref. 6060SB **£389**

Aged Brass Ref. 6060AB **£389**

Special Finishes

Allow 10 to 12 weeks delivery



Contour **6070**

The **Contour's** classical scroll detailing adds a real extravagance to the kitchen.

(Boxed 5)

Chrome Ref. 6070CP **£288**

Nickel Ref. 6070NI **£318**

Pewter Ref. 6070PF **£346**

Special finishes allow 10-12 weeks delivery

English Bronze Ref. 6070BZ **£361**

Gold Ref. 6070IG **£389**

Polished Brass Ref. 6070BR **£389**

Satin Brass Ref. 6070SB **£389**

Aged Brass Ref. 6070AB **£389**



Gold IG



Aged Brass AB



English Bronze BZ



Button **6080**

The **Button** has a flatter profile that provides a slightly more contemporary appearance than its Rounded cousin.

(Boxed 5)

Chrome Ref. 6080CP **£288**

Nickel Ref. 6080NI **£318**

Pewter Ref. 6080PF **£346**

Special finishes allow 10-12 weeks delivery

English Bronze Ref. 6080BZ **£361**

Gold Ref. 6080IG **£389**

Polished Brass Ref. 6080BR **£389**

Satin Brass Ref. 6080SB **£389**

Aged Brass Ref. 6080AB **£389**



Polished Brass BR



Satin Brass SB



Concave **6090**

The **Concave's** distinctive shape has a retro aesthetic that would suit both modern and traditional settings.

(Boxed 5)

Chrome Ref. 6090CP **£288**

Nickel Ref. 6090NI **£318**

Pewter Ref. 6090PF **£346**

Special finishes allow 10-12 weeks delivery

English Bronze Ref. 6090BZ **£361**

Gold Ref. 6090IG **£389**

Polished Brass Ref. 6090BR **£389**

Satin Brass Ref. 6090SB **£389**

Aged Brass Ref. 6090AB **£389**



Sensio Series 1 Lighting

This new range of lighting from Sensio offers a range of simple, high quality LED lights. The products come in one colour, in one finish, in one pack size complete with a driver.

Series 1 is simplicity without the compromise.

PLAZA Square LED Light

UNDER CABINET



- Stylish, slimline design
- Removable magnetic stainless steel bezel conceals fixings for a sleek finish
- Innovative etched design completely diffuses light - no visible dots. Ideal for under cabinet lighting
- Simple to install
- Compatible with Sensio switches, single-colour receiver and dimmable driver



Dimensions
100 x 100 x 6.5 mm

Weight
85 grams

IP Rating
20

PRODUCT CODE	LED COLOUR	QTY OF LIGHTS	WATTAGE	DRIVER INCLUDED?	PRICE
SE11090N0	Natural White	1	3.6	N/A	£14
SE11090N3	Natural White	3	10.8	Yes 15W	£67

VELOS Rectangular LED Light

UNDER CABINET



- Super slimline design
- Brushed aluminium finish
- Magnetic mounting plate conceals fixings for a clean finish
- Ideal for under cabinet lighting
- Elongated design allows for vast spread of light across worktop
- Suberb light output
- Wide, 120° beam angle eliminates dark areas
- Simple to install
- Natural white lighting, suitable for a range of kitchen styles



Dimensions 190 x 70 x 4 mm

Weight 55 grams

IP Rating 20

PRODUCT CODE	LED COLOUR	QTY OF LIGHTS	WATTAGE	DRIVER INCLUDED?	PRICE
SE11092N0	Natural White	1	5	N/A	£22
SE11092N3	Natural White	3	15	Yes 15W	£86

TREOS Slim Triangular LED Light

UNDER CABINET

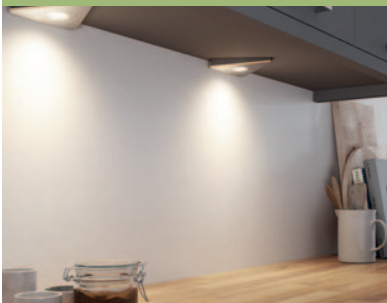

- Stylish, stainless steel triangular design
- Perfect under cabinet task lighting
- Fully diffused - no visible dots
- Easy to install plug and play technology
- Compatible with Sensio switches, single-colour receiver and dimmable driver
- Available in natural white making it ideal for a range of kitchen styles

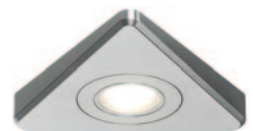

Dimensions
148 x 129 x 20.6 mm

Weight
124 grams

IP Rating
20

PRODUCT CODE	LED COLOUR	QTY OF LIGHTS	WATTAGE	DRIVER INCLUDED?	PRICE
SE11290N0	Natural White	1	1.9	N/A	£16
SE11290N3	Natural White	3	5.7	Yes 15W	£69

UNDER CABINET

AXIS Strip LED Light



- Ideal for under cabinet task lighting
- Diffused casing – no visible dots
- Available in 4 lengths ranging between 222mm and 904mm
- Can be interlinked with the integrated connector to achieve the optimum run of light
- Supplied with 1.5m of bare ended mains cable for simple installation
- Can be wired into mains wall switch for easy control or operated individually by a simple rocker switch

Dimensions	Weight
904 x 22 x 30 mm	219 grams
524 x 22 x 30 mm	167 grams
343 x 22 x 30 mm	142 grams
222 x 22 x 30 mm	125 grams

IP Rating 20

PRODUCT CODE	LED COLOUR	LENGTH IN MM	WATTAGE	DRIVER INCLUDED?	PRICE
SE10099N0	Natural White	904	16	N/A	£18
SE10079N0	Natural White	524	8	N/A	£14
SE10029N0	Natural White	343	5	N/A	£12
SE10019N0	Natural White	222	3	N/A	£10



UNDER CABINET

ZETA Round LED Light



Mounted

Dimensions
Ø65 x 11 mm

Weight
74 grams

IP Rating
20



Recessed

- Compact, stylish appearance
- Supplied with removable collar to allow for either a surface mounted or recessed finish
- Diffused light - no visible dots
- Stainless steel finish
- Ideal for under cabinet or in cabinet feature lighting
- Easy to install

PRODUCT CODE	LED COLOUR	QTY OF LIGHTS	WATTAGE	DRIVER INCLUDED?	PRICE
SE11190N0	Natural White	1	1.9	N/A	£12
SE11190N3	Natural White	3	5.7	Yes 6W	£57



PLINTH

IRIS Round Plinth LED Light



Dimensions
15 x 15 x 39.5 mm

Weight
21 grams

IP Rating
44

- A stylish, discreet fitting ideal for plinth boards
- Easy Plug & Play technology
- Fittings can be daisy chained for simple installation
- 2 x 75cm cable per fitting for daisy chain connection
- IP44 rated - protected against solid objects over 12mm (e.g. fingers) and protected against water drops at a 15 degree angle from the vertical
- Available in natural white, ideal for a range of kitchen styles

PRODUCT CODE	LED COLOUR	QTY OF LIGHTS	WATTAGE	DRIVER INCLUDED?	PRICE
SE15990N0	Natural White	1	0.32	N/A	£7
SE15990N4	Natural White	4	1.2	Yes 6W	£47



UNDER CABINET & PLINTH

DART Flexible Strip LED Light



Dimensions
500 x 8 x 1.75 mm

Weight
50 grams

IP Rating
20

- A simple, highly efficient flexible strip light with superb light output
- Available in natural white ideal for a range of kitchen styles
- Cut marks are indicated every 100mm to enable the strip to be cut closer to the desired length
- Supplied with a high-quality 3M VHB adhesive backing tape that sticks to any dry flat surface
- Supplied in a 5m reel

PRODUCT CODE	LED COLOUR	QTY OF LIGHTS	WATTAGE	DRIVER INCLUDED?	PRICE
SE10355N0	Natural White	N/A	18	N/A	£25
SE10355N1	Natural White	N/A	18	Yes 30W	£75



NEO TRIO TONE® - LED Light

UNDER CABINET



WATTAGE	BEAM ANGLE	FINISH	LIFESPAN	CABLE LENGTH
4.8W	120 degrees	Silver	35,000 hours	2.5 metres

PRODUCT CODE	LED COLOUR	QTY OF LIGHTS	LUMENS	DRIVER INCLUDED?	PRICE
SE11590T0	WW/NW/CW	1	308	No	£35
SE11590T3	WW/NW/CW	3	308	Yes 15W	£125

- An elongated light panel to create a wide spread of light across the worktop
- Featuring Prismatic LED technology
- Contains an innovative diffuser with an etched design to completely diffuse the light
- No visible diodes reflect off the worktop
- Superb, bright light output – CRI:90
- Dimmable (requires a suitable dimmable driver or receiver)
- Removable, magnetic front bezel simplifies installation and hides fixings
- Plug & Play connection
- Slim depth of just 10mm

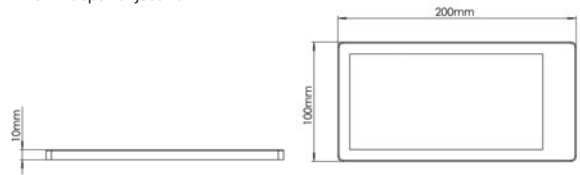

HORIZON TRIO TONE® - LED Light

UNDER CABINET



WATTAGE	BEAM ANGLE	FINISH	LIFESPAN	CABLE LENGTH
3.6W	110 degrees	Silver	35,000 hours	2.5 metres

PRODUCT CODE	LED COLOUR	QTY OF LIGHTS	LUMENS	DRIVER INCLUDED?	PRICE
SE11095T0	WW/NW/CW	1	220	No	£20
SE911980					£5

- SE11095T0 comes with Stainless Steel as standard Black SE911980 optional extra.
- A contemporary, slimline, under cabinet spot light
- TrioTone® technology allows you to select cool white, natural white or warm white with a flick of the switch , concealed under the front bezel
- Simple to install
- Removable, magnetic bezel conceals fixings for a sleek finish
- Innovative etched design completely diffuses light – no visible LED dots
- Superb lumen output for a flood of light
- Compatible with Sensio switches, single-colour receiver and Titan Smart Kinetic driver

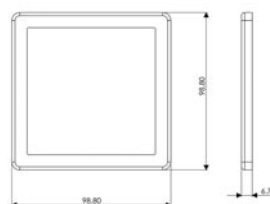

SE9009 2.5m Extension Cable **£4**

UNDER CABINET

ASTRO TRIO TONE® - LED Light

- Super slimline design
- Brushed aluminium, black, brass or copper finish
- Magnetic mounting plate installation conceals fixings for a clean finish
- Ideal for under cabinet lighting
- TrioTone® technology allows you to select cool white, natural white or warm white with a flick of the switch on the back fitting
- Elongated design allows for vast spread of light across the worktop
- Suberb light output – CRI : 90
- Wide, 120° beam angle eliminates dark areas
- Simple to install
- Compatible with Sensio switches, single-colour receiver and dimmable driver

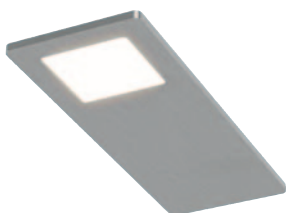
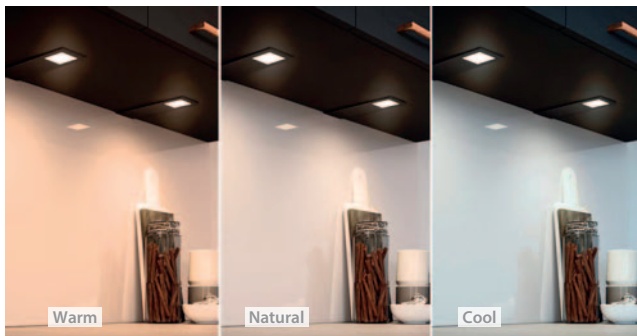
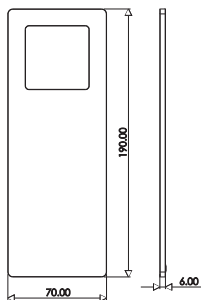

Titan+ **Brushed Aluminium**
Black, Brass and Copper finishes available by special order, allow 4 weeks delivery.

PRODUCT CODE	FINISH	WATTAGE	VOLTAGE	QTY OF LIGHTS	LUMENS	DRIVER	PRICE
SE11190T0	Brushed Aluminium	4.8W	24V	1	280-300 lm	Required	£32
SE11190T3	Brushed Aluminium	14.4 W	24V	3	280-300 lm	15W Included	£116
SE11198T0	Black	4.8 W	24V	1	280-300 lm	Required	£34
SE11198T3	Black	14.4 W	24V	3	280-300 lm	15W Included	£121
SE11196T0	Brass	4.8 W	24V	1	280-300 lm	Required	£35
SE11196T3	Brass	14.4 W	24V	3	280-300 lm	15W Included	£123
SE11197T0	Copper	4.8 W	24V	1	280-300 lm	Required	£35
SE11197T3	Copper	14.4 W	24V	3	280-300 lm	15W Included	£123

SE9009 2.5m Extension Cable £4

UNDER CABINET HYPE TRIO TONE® - LED Surface/Recessed Light

PRODUCT CODE	LED COLOURS	QTY OF LIGHTS	LUMENS	DRIVER INCLUDED?	PRICE
SE21100	WW/NW/CW	1	130 -150	No	£22
SE21100K3	WW/NW/CW	3	130 -150	Yes 6W	£84



- One light, three colour temperatures
- Choose between Cool White, Natural White and Warm White by flicking a switch on the back of the fitting
- Simple to use and easy to install, choose the colour temperature that suits your kitchen
- Fitting supplied with collar for surface mounting
- Sleek appearance
- Diffused light - no visible dots
- Luminous efficacy of 85-95 lm/W

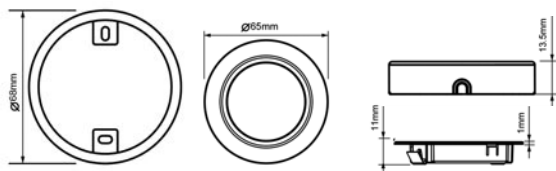

SE9009 2.5m Extension Cable £4

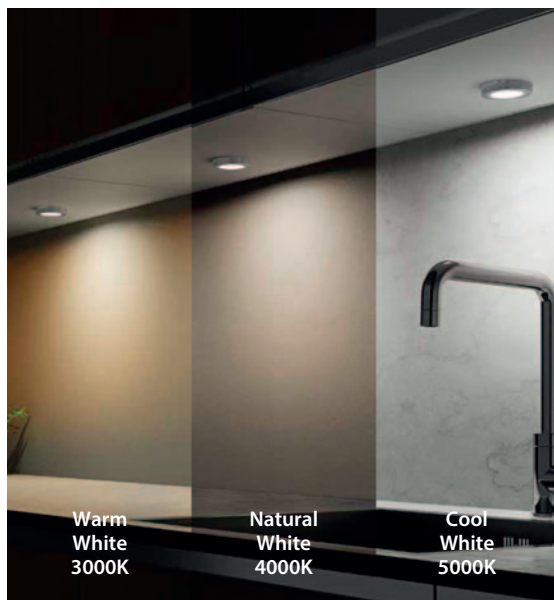

WATTAGE	BEAM ANGLE	FINISH	LIFESPAN	CABLE LENGTH
2W	110 degrees	Stainless Steel	35,000 hours	1.5 metres

SIGMA 2 - Bendable LED Flexible Strip UNDER CABINET & PLINTH



PRODUCT CODE	LED COLOUR	LENGTH	WATTAGE	LUMENS	DRIVER INCLUDED?	PRICE
SE10855C1	Cool White	5m	24W	1990	Yes 30W	£86
SE10855W1	Warm White	5m	24W	250	Yes 30W	£86

PRODUCT CODE	DESCRIPTION	PRICE
SE970850*	Driver Connection Lead (Included in kits) * Required to run the Sigma LED Flexible Strip	£6
SE970950	Joining Clip	£2
SE101050	Corner Connection Lead (50mm)	£3
SE970750	Interconnecting Lead (1.5m)	£5
SE9009	2.5m Extension Cable	£4

- An innovative bendable flexible strip that handles corners with ease
- A unique PCB board cut in a 'zig-zag' shape provides superb flexibility allowing you to bend the light around a corner
- Can be bent around 90 degree corners without the need for corner cables or starting a new run of strip
- The entire reel can be used with cut marks indicated every 50mm avoiding wastage
- Cut sections are re-utilised with the joining clips and leads (sold separately)
- Compatible with Sensio single-colour receiver to enable dimming functionality
- Supplied with 3M VHB (Very High Bond) adhesive tape backing for secure installation
- IP20 rated - protected against solid objects over 12mm (e.g. fingers)
- Supplied in a 5m reel

WATTAGE	BEAM ANGLE	FINISH	LIFESPAN
24W	120 degrees	White	35,000 hours

SE101050 **SE970950**

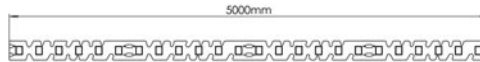

Cool White 5000K



Warm White 3000K

POLAR - COB LED Flexible Strip

PLINTH



Polar COB LED Flexible Strip - Cool White (6000K), 512 LED/m

PRODUCT CODE	WATTAGE	VOLTAGE	LENGTH	LUMENS	DRIVER	PRICE
SE20055C0	6 W/m	24V	5000mm	600lm/m	Required	£114
SE20055C1	6 W/m	24V	5000mm	600lm/m	30W Included	£143

Polar COB LED Flexible Strip - Natural White (4000K), 512 LED/m

PRODUCT CODE	WATTAGE	VOLTAGE	LENGTH	LUMENS	DRIVER	PRICE
SE20125N0	6 W/m	24V	2000mm	600lm/m	Required	£47
SE20125N1	6 W/m	24V	2000mm	600lm/m	15W Included	£78
SE20055N0	6 W/m	24V	5000mm	600lm/m	Required	£114
SE20055N1	6 W/m	24V	5000mm	600lm/m	30W Included	£143

Polar COB LED Flexible Strip - Warm White (3000K), 512 LED/m

PRODUCT CODE	WATTAGE	VOLTAGE	LENGTH	LUMENS	DRIVER	PRICE
SE20055W0	6 W/m	24V	5000mm	600lm/m	Required	£114
SE20055W1	6 W/m	24V	5000mm	600lm/m	30W Included	£143

- Provides a completely diffused line of light with no visible LED dots eliminating the need for a profile or cover
- Chip on Board technology provides superior light output
- Excellent thermal conduction resulting in a cool running strip
- Superb light output with high lumen per watts
- 24V allows long runs of light without any light fade
- Compatible with Sensio single-colour receiver to enable dimming functionality
- Supplied with pre-soldered, 1.5m driver connection cables with a 2-pin connector at each end of the strip (2m reels one lead and connector only)
- Can be cut to length (every 31mm) and the whole reel can be utilised with the Polar Joining Clips (sold separately)
- Supplied in a 5m reel (and 2m in natural white only)
- Very High Bond adhesive tape backing for secure installation
- Compatible with the Universal Profile range

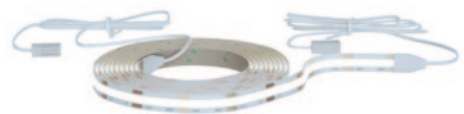

Polar Cables, Connectors & Accessories

CODE	DESCRIPTION	PRICE
SE112940	Polar Transparent Joining Clip	£3
SE112990	Polar Joining Clip	£3
SE105790	1.5m Polar Interconnecting Lead	£3
SE105990	50mm Polar Corner Connector	£2
SE103990	2.5m Polar Driver Connection Lead	£4
SE9009	2.5m Extension Cable	£4

UNDER CABINET & PLINTH

VIVA 3 - Multi LED Flexible Strip

PRODUCT CODE	LED COLOUR	LENGTH	WATTAGE	LUMENS	DRIVER INCLUDED?	PRICE
SE10715C0	Cool White	1000mm	4W	149	No	£15
SE10715C1	Cool White	1000mm	4W	298	Yes 6W	£42
SE10725C1	Cool White	2000mm	8W	596	Yes 15W	£58
SE10715W0	Warm White	1000mm	4W	139	No	£15
SE10715W1	Warm White	1000mm	4W	278	Yes 15W	£42
SE10725W1	Warm White	2000mm	8W	556	Yes 15W	£58

PRODUCT CODE	DESCRIPTION	PRICE
SE10314*	Driver Connection Lead (Included in kits) * Required to run the Viva 3 LED Flexible Strip	£4
SE10317	Interconnecting Lead (1.5m)	£3
SE10316	Corner Connection Lead (50mm)	£3
SE10318MCC	Cut Joining Connector	£4

- A versatile flexible strip light which can be used in multiple areas of the kitchen or bedroom including under cabinet, plinths or inside wardrobes
- Strip can be cut once and the cut off section used with a cut joining connector
- Can be cut to length every 50mm
- Male and female ends for simple installation
- Supplied with 3M VHB (Very High Bond) adhesive tape backing for secure installation
- IP54 rated - limited ingress of dust and protected against sprays from any angle
- Supplied in 1m and 2m reels



BEAM ANGLE	FINISH	LIFESPAN
20 degrees	White	35,000 hours



PLINTH

HALO TRIO TONE® - Round Plinth LED Light

PRODUCT CODE	LED COLOUR	QTY OF LIGHTS	LUMENS	DRIVER INCLUDED?	PRICE
SE150004	WW/NW/CW	4	10	No	£60
SE150084	WW/NW/CW	4	10	No	£62
SE150000	Stainless Steel - Single Light				£10
SE150080	Black - Single Light				£10

SE150004 - Aluminium SE150084 - Black

- 2 x 1m cables per fitting
- Available individually or as a pack of 4 or 8
- 15mm fittings - very discreet
- Fittings can be daisy chained together
- Can be used with range of Sensio switches and dimmers

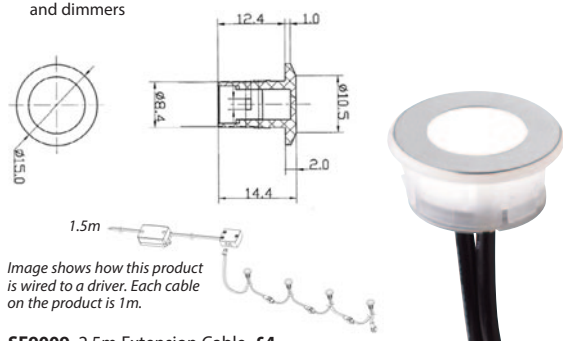

Image shows how this product is wired to a driver. Each cable on the product is 1m.

SE9009 2.5m Extension Cable £4



WATTAGE	BEAM ANGLE	FINISH	LIFESPAN	CABLE LENGTH
0.24W	90 degrees	Transparent PC	20,000 hours	2 metres

TITAN Dimmable Driver

- Depth of 16mm
- Integrated 2-pin connector, distributor ports
- 2m mains cable included
- Short circuit & overload protection
- Surge and thermal protection
- Wide dimming range: 5% - 100%
- Wall dimmable
- Easy to use - Just plug and play
- Minimum 25% load



Multiple Lighting Lines on all Titan Drivers
Simultaneously run multiple light lines.
Just remember to total the wattage.

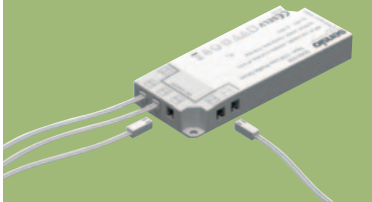

Titan Dimmable Driver

PRODUCT CODE	VOLTAGE	WATTAGE	NO. OF PORTS	PRICE
SE40899	24V	30W	4	£43
SE40699	24V	60W	10	£50

Titan Cables, Connectors & Accessories

PRODUCT CODE	DESCRIPTION	PRICE
SE990990	*Driver Port Expander	£3

*Increase the capacity of the driver with an additional 10 ports.

TITAN+ Sensor Driver

- Slim 16mm depth
- Easy to use and install
- Available as 6W/15W/30W
- Integrated 2-pin connector, distribution ports
- Compatible lighting control accessories - PIR, IR, Switch & Door sensors. Simply plug in the chosen sensor to the designated port in the driver.
- Mains cable included
- Dimmable when paired with the Titan+ IR sensor

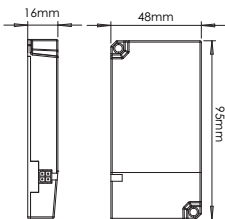

Titan+ 6W Driver

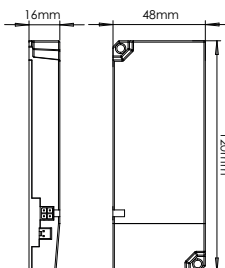

Titan+ 15W Driver

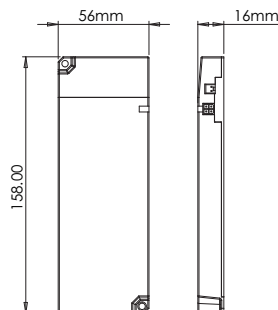

Titan+ 30W Driver

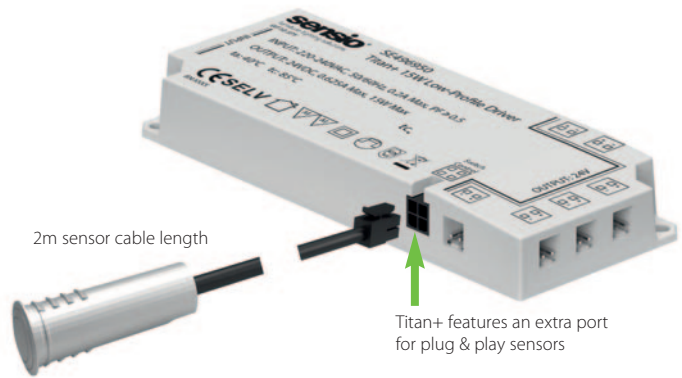

Titan+ Sensor Driver

PRODUCT CODE	WATTAGE	NO. OF PORTS	PRICE
SE495950	6W	4	£24
SE496950	15W	6	£29
SE497950	30W	6	£47

Titan+ Cables, Connectors & Accessories

PRODUCT CODE	DESCRIPTION	PRICE
SE490250	IR Sensor	£15
SE491250	PIR Sensor	£17
SE492250	Push Switch	£8
SE493250	Door Sensor	£14
SE990990	*Driver Port Expander	£3

*Increase the capacity of the driver with an additional 10 ports.

ALUMINIUM PROFILES

BEAM - Angled

- All Sensio flexible strips will fit inside the profile (10mm inner channel)
- Supplied with one cut out end cap and one with no cut-out for a neat finish
- Mounting brackets and end caps supplied with each profile
- Angled to spread evenly diffused light
- Available in 2.2m and 1m lengths
- 16mm x 16mm
- Opal PC cover to diffuse the LED points

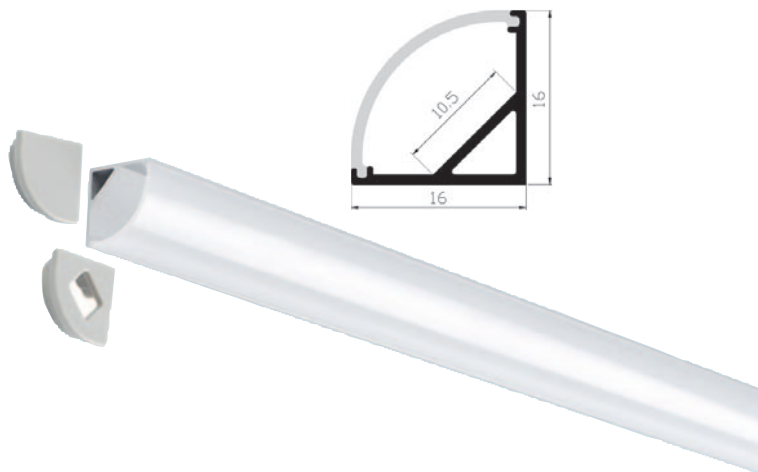

PRODUCT CODE	LENGTH	PRICE
SE982120	1000mm	£11
SE982220	2200mm	£22
PRODUCT CODE	DESCRIPTION	PRICE
SE983050	2 x End Caps	£2
SE984050	2 x Mounting Brackets	£2

ALUMINIUM PROFILES

LINIA - Recessed

- End caps protrude (10mm) to fill the gap in furniture when cut with a router for neat finish
- End caps supplied with each profile (2 with the 1m, 4 with the 2.2m)
- Perfect for use under cabinets, inside larders or wardrobes
- Flush fit for a minimalist look
- Aluminium finish
- Houses all Sensio flexible strips
- Streamlined finish

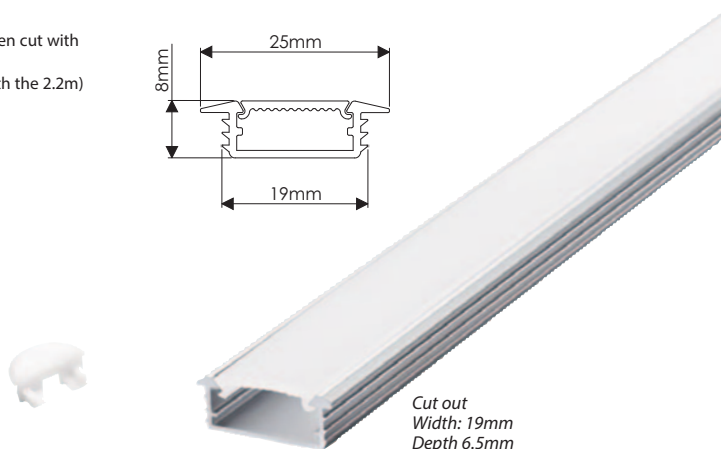
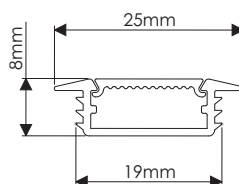

*Cut out
Width: 19mm
Depth 6.5mm*

PRODUCT CODE	LENGTH	PRICE
SE980120	1000mm	£10
SE980220	2200mm	£22
PRODUCT CODE	DESCRIPTION	PRICE
SE980920	2 x End Caps	£2

ALUMINIUM PROFILES

FINO - Surface Mounted

- Perfect for use inside cabinets, larders or wardrobes
- End caps (2mm) and mounting brackets supplied with each profile (2 with the 1m, 4 with the 2m)
- Aluminium finish
- Streamlined finish
- Houses all Sensio flexible strips

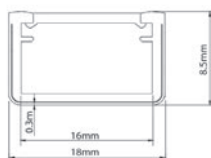

PRODUCT CODE	LENGTH	PRICE
SE981120	1000mm	£10
SE981220	2000mm	£22
PRODUCT CODE	DESCRIPTION	PRICE
SE982050	2 x End Caps	£2
SE981050	2 x Mounting Brackets	£2

KETTLE TAPS



FILTERED KETTLE HOT WATER ON TAP

Once you have one,
you'll wonder how you
ever lived without it.



OPTIONS

SINGLE FUNCTION

Filtered 98°C water

DUAL FUNCTION

Filtered 98°C water

Filtered cold water

TRIPLE FUNCTION

Domestic hot water

Domestic cold water

Filtered 98°C water

QUADRUPLE FUNCTION

Domestic hot water

Domestic cold water

Filtered 98°C water

Filtered cold water



KETTLE TAP BENEFITS

SPEED

No more waiting for the kettle to boil - 98°C hot filtered water is always instantly available. It takes up to 5 minutes to boil a litre of water using an electric kettle, it takes zero minutes using a Kettle tap.

TASTE

The water before entering the boiler is filtered to remove impurities, resulting in fresh odour-less 98°C hot water for superior tasting drinks.

WATER SAVING

You only dispense the precise amount of hot water you need, so you save on water and energy consumption.

SAFETY

All the Kettle taps come with insulated spout technology and child-safe controls.

CLEAR THE DECKS

Declutter your work surfaces by ditching your kettle, all your boiling water requirements are fulfilled with a Kettle tap.



Kettle Taps

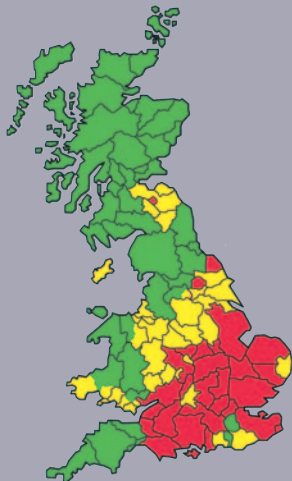

UK SCALE MAP

-  Hard to Very Hard
-  Medium Hardness
-  Soft

As well as filtering out chlorine and dissolved metals all our filter taps reduce calcium substantially improving the taste and also prolonging the lives of kettles and steam irons.

MAGUS 3

The Clearwater **Magus 3** IN 1 Kettle tap combines great aesthetics with outstanding functionality making it an indispensable time-saving appliance in the kitchen. Its versatility means it dispenses domestic hot and cold water as well as 98°C steaming hot, filtered water.

This brilliant kitchen assistant means no more waiting for the kettle to boil and instead you have immediate kettle hot perfectly tasting water for beverages and cooking.

CHROME BRUSHED NICKEL PVD REGENCY COPPER PVD BRUSHED BRASS PVD MATT BLACK

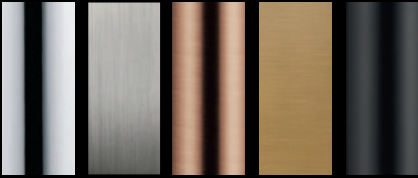

Chrome



Brushed Brass PVD

MAGUS 3 J SPOUT

- Ref. MAE2KCP Chrome £714
- Ref. MAE2KBN Brushed Nickel PVD £749
- Ref. MAE2KBC Regency Copper PVD £771
- Ref. MAE2KBB Brushed Brass PVD £771
- Ref. MAE2KMB Matt Black PVD £771

Included: Thermostatic Boiler, Filter Cartridge and Connectors
WRAS Approved



Matt Black

MAGUS 3 U SPOUT

- Ref. MAE3KCP Chrome £714
- Ref. MAE3KBN Brushed Nickel PVD £749
- Ref. MAE3KBC Regency Copper PVD £771
- Ref. MAE3KBB Brushed Brass PVD £771
- Ref. MAE3KMB Matt Black PVD £771

Included: Thermostatic Boiler, Filter Cartridge and Connectors
WRAS Approved





Brushed Nickel PVD

FUNCTIONS

- **3 Functions** - domestic hot, domestic cold, 98°C filtered water.
- **Child safe operation** - spring loaded lever dispenses 98°C filtered water.
- **Cool touch spout** - centrally insulated 98°C channel ensuring spout remains safe to touch.
- **Advanced filtration** - protects the boiler from lime-scale formation, removes contaminants and improves taste and odour of the water to achieve the perfect hot & cold drinks.

FILTER CARTRIDGE

The filter cartridge included has a 6 month life span and a capacity of 3800 litres.

Replacement Cartridges
Ref. F6C1 - £72 - WRAS Approved

An optional filter with a 12 month life span is also available with a capacity of 7600 litres.

Ref. F12C1 - £112 - WRAS Approved



DIGITAL THERMOSTATIC BOILER

- **2.4 Litre capacity** - instant kettle hot water, capable of providing 60 cups per hour.
- **Simple installation** - non-specialist fitting uses standard 13 amp plug.
- **Anti-scale filter provided** - reduces lime-scale and improves water quality.
- **State-of-the-art Digital controls** - accurate to 0.5 degrees variable.
- **10 temperature settings** - from 45° to 98°.
- Operates from 1.5 bar.
- Ultra compact design.
- Automated Filter Reminder System.
- 2 year warranty.

Boiler Dimensions

Width 188 mm
Depth 188 mm
Height 270 mm



MAGUS 4 ELECTRONIC ^{kettle}



Magus 4 with Modern Pull-Out Spray in Matt Black - see page 262

For chilled filtered water see our **Chiller** on page 209.

THERMOSTATIC BOILER

For specification and dimensions see Magus 3 Kettle tap on page 175.



FILTER CARTRIDGE

The filter cartridge included has a 6 month life span and a capacity of 3800 litres.

Replacement Cartridges

Ref. F6C1 £72 - WRAS Approved

An optional filter with a 12 month life span is also available with a capacity of 7600 litres.

Ref. F12C1 £112 - WRAS Approved



- **4 Functions** - domestic hot, domestic cold, 98°C filtered water and cold filtered water.
- **Press & Hold or Hands-Free Kettle operation** - the Magus 4 is programmed to dispense water by pressing and holding control or simply press twice for hands-free mode.
- **Child safe operation** - advanced electronic control with LED illumination denoting hot function.
- **Cool touch spout** - centrally insulated 98°C channel ensuring spout remains safe to touch.
- **Advanced filtration** - protects the boiler from limescale formation, removes contaminants and improves taste and odour of the water to achieve the perfect hot and cold drinks.

KETTLE CONTROL

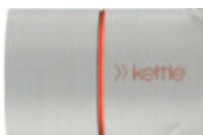

- 1 LED glows Blue - indicates the child lock is on.
- 2 Press control for 3 seconds to unlock - LED glows red and flickers.
- 3 Press control again and hold to dispense 98°C water - LED glows constant red.
- 4 Release pressure on control to cease flow - LED glows blue after 10 seconds, child lock on.
- 5 Hands-free control - Press control twice to dispense 98° filtered water - auto switch off after 60 seconds (approx 2 litres). To stop continuous flow press control again.



The **Magus 4 Electronic** really is the complete package; it combines elegant design with intuitive controls that deliver four water options. The left-hand LED electronic control dispenses 98°C filtered water at the touch of a button while the right-hand lever delivers domestic hot and cold water as well as fresh tasting cold filtered water. When you own a Magus 4 you will never need to use your kettle or buy bottled water again!



Matt Black

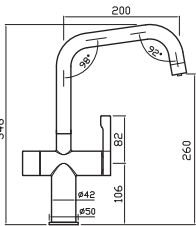

Magus 4 in 1

- Ref. MAE4CP Chrome **£850**
- Ref. MAE4BN Brushed Nickel PVD **£883**
- Ref. MAE4BC Regency Copper PVD **£907**
- Ref. MAE4BB Brushed Brass PVD **£907**
- Ref. MAE4MB Matt Black **£907**

Included: Thermostatic Boiler, Filter Cartridge and Connectors

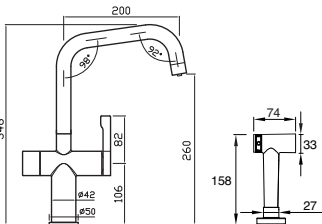

Magus 4 in 1 with Dual Pull-Out Spray

- Ref. MAER4CP Chrome **£950**
- Ref. MAER4BN Brushed Nickel PVD **£997**
- Ref. MAER4BB Brushed Brass PVD **£1031**
- Ref. MAER4MB Matt Black **£1026**

Included: Thermostatic Boiler, Filter Cartridge and Connectors



Brushed Nickel : Filtered Water

HOTSHOT kettle



The **Hotshot 1** is a compact filtered hot water tap which can be set alongside your main tap or installed with a secondary sink creating a fantastic entertaining area.

The Hotshot 1 can also be fitted with a font extending its application away from the kitchen, for example try fitting in the home office for that instant coffee fix.

The **Hotshot 2** brings even more to the party by not only dispensing 98°C super-hot water but also great tasting, cold filtered water, making this little tap the perfect choice for entertaining.

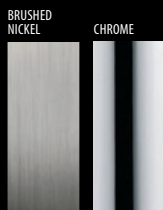

THERMOSTATIC BOILER



For specification and dimensions see **Magus 3 Kettle tap** on page 175.

HOTSHOT 1

FILTERED KETTLE
HOT WATER

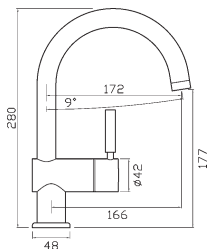

Hotshot 1 Filtered Kettle Hot

Ref. HOT1CP Chrome **£399**

Ref. HOT1BN

Brushed Nickel PVD **£449**

Included: Thermostatic Boiler, Filter Cartridge and Connectors
WRAS Approved





Chrome

HOTSHOT 2

FILTERED KETTLE
HOT & COLD PURE
DRINKING WATER



Insulated anti-scald spout



Child-safe anti-scald lock control with push-down mechanism and springback valve

Brushed Nickel PVD

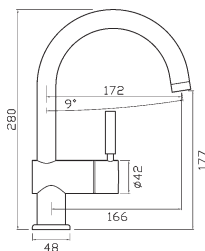

Hotshot 2 Filtered Kettle
Hot and Filtered Cold

Ref. HOT2BN

Brushed Nickel PVD **£489**

Included: Thermostatic Boiler, Filter Cartridge and Connectors
WRAS Approved



FILTER CARTRIDGE

The filter cartridge included has a 6 month life span and a capacity of 3800 litres.

Replacement Cartridges

Ref. F6C1 - £72
WRAS Approved

An optional filter with a 12 month life span is also available with a capacity of 7600 litres.

Ref. F12C1 - £112
WRAS Approved

LONGDON 4



Brushed Brass PVD



Chrome

Brushed Nickel PVD

Brushed Brass PVD

Brushed Bronze PVD

The **Longdon** hides some very smart tech behind its softly sculptured exterior - its 4 in 1 technology is controlled by two elegant ceramic levers, these dispense 98 degree hot and cold filtered water for drinks and cooking as well as a standard domestic hot/cold supply. The curvy aesthetic of the Longdon allows this versatile tap to be at home in both modern and traditional settings and with its ceramic levers make a perfect alliance with fireclay sinks. It is available with an incredibly useful matching handspray, see page 263 for more info.

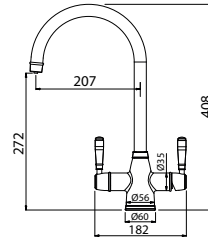

Longdon 4 in 1 Traditional

Ref. LON4CP Chrome £799

Ref. LON4BN Brushed Nickel PVD £835

Ref. LON4BB Brushed Brass PVD £835

Ref. LON4BZ Brushed Bronze PVD £859

Included: Thermostatic Boiler, Filter Cartridge and Connectors

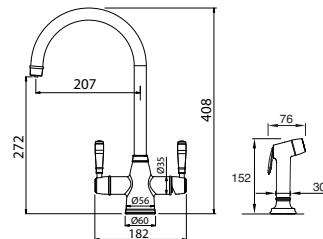

Longdon 4 in 1 Traditional with Dual Pull-Out Spray

Ref. LONR4CP Chrome £908

Ref. LONR4BN Brushed Nickel PVD £959

Ref. LONR4BB Brushed Brass PVD £968

Ref. LONR4BZ Brushed Bronze PVD £997

Included: Thermostatic Boiler, Filter Cartridge and Connectors





Brushed Nickel PVD

Traditional Pull-Out Spray in Brushed Nickel - see page 263

FUNCTIONS

- **4 Functions** - domestic hot, domestic cold, 98°C filtered water and cold filtered water.
- **2 Stage Child Safe operation** - press down unlock and spring loaded lever dispenses 98°C filtered water.
- **Cool touch spout** - centrally insulated 98°C channel ensuring spout remains safe to touch.
- **Advanced filtration** - protects the boiler from lime-scale formation, removes contaminants and improves taste and odour of the water to achieve the perfect hot & cold drinks.

FILTER CARTRIDGE

The filter cartridge included has a 6 month life span and a capacity of 3800 litres.

Replacement Cartridges
Ref. F6C1 - £72 - WRAS Approved

An optional filter with a 12 month life span is also available with a capacity of 7600 litres.

Ref. F12C1 - £112 - WRAS Approved



DIGITAL THERMOSTATIC BOILER

- **2.4 Litre capacity** - instant kettle hot water, capable of providing 60 cups per hour.
- **Simple installation** - non-specialist fitting uses standard 13 amp plug.
- **Anti-scale filter provided** - reduces lime-scale and improves water quality.
- **State-of-the-art Digital controls** - accurate to 0.5 degrees variable.
- **10 temperature settings** - from 45° to 98°.
- Operates from 1.5 bar.
- Ultra compact design.
- Automated Filter Reminder System.
- 2 year warranty.

Boiler Dimensions

Width 188 mm
Depth 188 mm
Height 270 mm





Black Velvet

3N1 HOT TAP

Hot, cold and filtered steaming hot water. Luxury and convenience at your fingertips.

At the pull of a lever, the 3N1 steaming hot water tap can dispense steaming hot filtered water, regular hot or regular cold water, replacing your main tap.

Ideal for making hot drinks, cleaning, preparing pasta and more.

- Premium contemporary Italian design.
- Safe, multi-step hot water handle.
- Easy to install.
- 5 year tap guarantee and 2 year tank guarantee.
- Tap comes complete with space-saving tank and filter.



Rose Gold

3N1 'J' Spout Hot Filtered water tap

Ref. 45097 Polished Chrome **£1166**

Ref. 45097B Brushed Steel **£1382**

Ref. 45097AT Rose Gold **£1420**

Ref. 45097AW Black Velvet **£1498**

43961 filter included

Capacity: 2.5 litre stainless steel tank dispenses approximately 100 cups of 98°C water per hour

Required hole diameter: 35-38mm

Required supply pressure: 1.7 to 8.6 bar

WRAS Approved



Brushed Gold

3N1 'L' Spout Hot Filtered water tap

Ref. H3N1C Polished Chrome **£1200**

Ref. H3N1B Brushed Steel **£1422**

Ref. H3N1BK Black/Chrome **£1382**

Ref. H3N1BG Brushed Gold **£1420**

Ref. H3N1A Anthracite **£1422**

Ref. H3N1AW Black Velvet **£1498**

43961 filter included

Capacity: 2.5 litre stainless steel tank dispenses approximately 100 cups of 98°C water per hour

Required hole diameter: 35-38mm

Required supply pressure: 1.7 to 8.6 bar

WRAS Approved

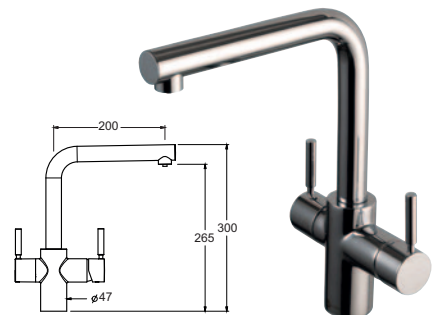

insinkerator
4=1
TOUCH

The new **4N1** taps offer the ultimate in kitchen convenience. As well as dispensing regular hot and cold water they also offer filtered cold and steaming hot water.

Produced to the highest manufacturing standards it streamlines your sleek worktop with a single appliance.

- Glowing filter touch button technology.
- Safety multi-step hot water handle.
- Smooth laminar flow.
- 5 year tap parts and labour limited warranty.
- Tap comes complete with space-saving tank and filter.



Glowing filter touch-button technology

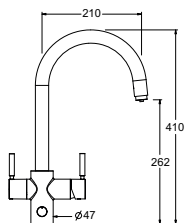

4N1 'J' Spout Filtered Cold & Steaming Hot water and Regular Hot and Cold water

Ref. 45357 Polished Chrome **£1433**

Ref. 45357B Brushed Steel **£1600**

Ref. 45357AW Black Velvet **£1600**

43961 filter included

Required hole diameter: 35-38mm

Required supply pressure: 1.7 to 8.6 bar

WRAS Approved

NeoTank and Filter

- The tanks and filters have been designed specifically for InSinkEerator taps to maximise their efficiency and longevity.
- They are just as easily retro-fitted as they are integrated into a brand new kitchen design.
- The innovative 2.5 litre NeoTank features a precise and adjustable digital touch-screen thermostat control, enabling users to set the desired temperature of the water between 88° and 98°C - the perfect temperature for hot drinks.
- Energy efficient, uses less energy than a 40-watt light bulb.
- 2 year tank parts and labour limited warranty.



Kettle Taps

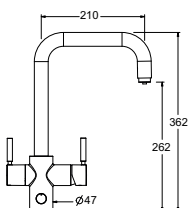

4N1 'U' Spout Filtered Cold & Steaming Hot water and Regular Hot and Cold water

Ref. 45358 Polished Chrome **£1433**

Ref. 45358B Brushed Steel **£1600**

Ref. 45358AW Black Velvet **£1600**

43961 filter included

Required hole diameter: 35-38mm

Required supply pressure: 1.7 to 8.6 bar

WRAS Approved

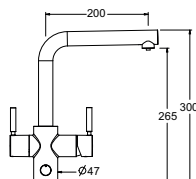

Polished Chrome



Brushed Steel

4N1 'L' Spout Filtered Cold & Steaming Hot water and Regular Hot and Cold water

Ref. 45356 Polished Chrome **£1433**

Ref. 45356B Brushed Steel **£1600**

Ref. 45356AW Black Velvet **£1600**

43961 filter included

Required hole diameter: 35-38mm

Required supply pressure: 1.7 to 8.6 bar

WRAS Approved





KETTLE HOT TAPS

Once you have one, you'll wonder how you ever did without it. No kettles, no leads, no clutter, no fuss... Just 98° C of steaming hot water or cold filtered water at the flick of a lever. With their elegantly sleek lines, Insinkerator models don't just bring style to the kitchen; they bring a level of convenience that fits today's busy lifestyles.

The GN1100, GN2215, H330 & 3N1 models produces hot filtered water, while the HC1100, HC2215 & HC300 offers both hot and cold filtered water from the same tap. Both feature an unobtrusive filter system under the sink that reduces chlorine, lead, turbidity and other unpleasant tastes and odours.

They only heat the water you use, making the household more energy efficient. The HC1100 tap with the added cold filtered water feature provides a cost effective alternative to buying bottled water. All taps have a 5 year warranty.



The hot water boiler and initial filter are included with the tap. The boiler has a 2 year warranty.

1100 SERIES

The **1100 series** have a café chic design and will sit discreetly in the kitchen providing an invaluable service. Includes Hot Water and Filter System and safety control on levers. **WRAS Approved**

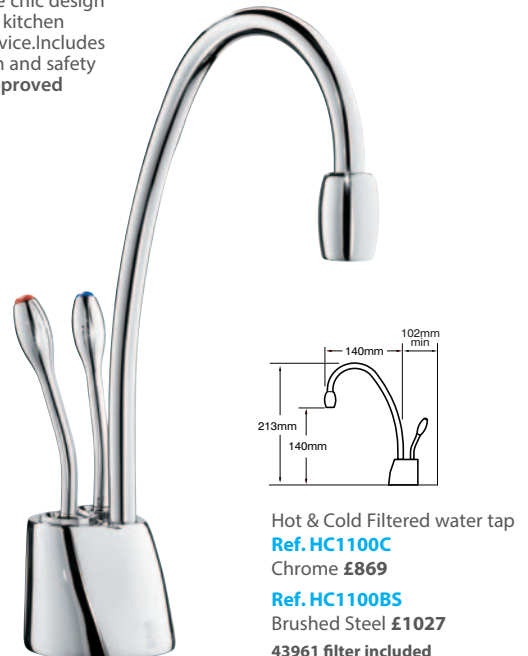



3300 SERIES

A great choice for the contemporary kitchen the mini swan neck design will match many of today's tap designs.

Includes Hot Water and Filter System and safety control on levers.

WRAS Approved

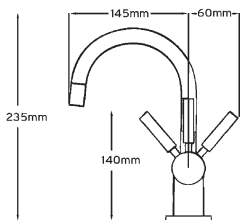

Hot Filtered water tap
Ref. H3300C
 Chrome **£881**
Ref. H3300B
 Brushed Steel **£987**
 43961 filter included



Hot & Cold Filtered water tap
Ref. HC3300C Chrome **£996**
Ref. HC3300B Brushed Steel **£1125**
 43961 filter included

RefNo. 43961
 Replacement filter packs containing 2 filters **£119**

The first 43961 filter will come standard with GN and HC systems. It is a chlorine, taste and odour filter with additional lead protection and a scale reduction capability. It filters sediment at a 5 micron level.



Brushed Steel



Water Pressure Explained - page 219

HOT TAPS

Innovative 3 in 1 instant hot mixers, perfect for hot drinks, cooking, food prep and cleaning. Available in 'U' or 'C' spout design.

All the taps have a 5 year warranty.

Prices include Digital Tank and Filter.



PHOENIX 3-IN-1 INSTANT HOT SINK MIXER

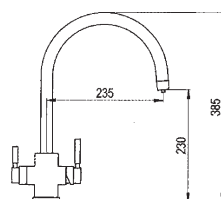

Phoenix 3 in1 Instant Hot sink mixer with C spout

Ref. 1912CP Chrome **£1339**

Ref. 1912NI Polished Nickel **£1401**

Ref. 1912PF Pewter **£1463**

Capacity: 2.4 litre tank

Required hole diameter: 35mm

Required supply pressure:  1.5 min



POLARIS

THE ONLY REALLY TRADITIONAL
3-IN-1 INSTANT HOT TAP

Perrin & Rowe quality build traditional 3-in-1 instant hot sink mixer with anti scald locking mechanism. The tap has a 5 year warranty. Prices include Digital Tank and Filter.

Polaris 3 in1 Instant Hot sink mixer

Ref. 1937CP
Chrome **£1339**

Ref. 1937NI
Polished Nickel **£1401**

Ref. 1937PF
Pewter **£1463**

Ref. 1937IG
Gold **£1555**

Capacity: 2.4 litre tank
Required hole diameter: 35mm
Required supply pressure:
HP 1.5 min

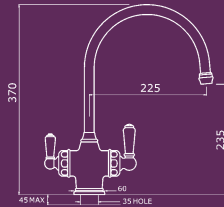

Unique Tank Features

- Unique anti-scald locking mechanism on all instant hot models
- Operates from as low as 1.5 bar
- Multiple pre-set temperatures ranging from 75°C to 98°C
- State of the art digital touch screen display
- Digital temperature control accurate to 0.5 degrees celsius
- Rapid reheat with zero run off and spit free
- Water saving, time saving and energy efficient
- Hi-flow
- Easy to install and use
- UK manufacturer
- 2 year warranty

MINI INSTANT HOT WATER TAPS

ALL MINI INSTANT HOT WATER TAPS
COME WITH ANTI-SCALD LOCK

Mimas Mini Instant Hot water tap
Ref. 1347CP Chrome **£1170**
Ref. 1347NI Polished Nickel **£1215**
Ref. 1347PF Pewter **£1260**

Capacity: 2.4 litre tank
Required hole diameter: 35mm
Required supply pressure: 1.5 min

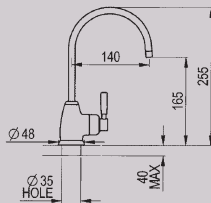

Parthian Mini Instant Hot water tap
Ref. 1307CP Chrome **£1178**
Ref. 1307NI Polished Nickel **£1224**
Ref. 1307PF Pewter **£1269**
Ref. 1307IG Gold **£1338**

Capacity: 2.4 litre tank
Required hole diameter: 35mm
Required supply pressure: **HP** 1.5 min

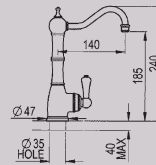
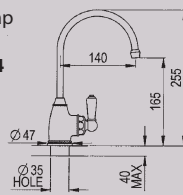

Aquitaine Mini Instant Hot water tap
Ref. 1323CP Chrome **£1234**
Ref. 1323NI Polished Nickel **£1285**
Ref. 1323PF Pewter **£1337**
Ref. 1323IG Gold **£1414**

Capacity: 2.4 litre tank
Required hole diameter: 35mm
Required supply pressure: **HP** 1.5 min



Chrome



ARMSTRONG HOT TAPS

The **Armstrong** Industrial range includes a 3 in 1 mixer to be used as the principal mixer tap and a smart dedicated Hot & Filtered mixer which can be used as a secondary tap.
Prices include Digital Tanks and Filter.

Armstrong 3 in 1 Instant Hot sink mixer with C spout and textured lever handles

Ref. 1985HT CP Chrome **£1412**

Ref. 1985HT NI Polished Nickel **£1481**

Ref. 1985HT PF Pewter **£1549**

Special Finishes **£1652**

English Bronze **£1583**

Capacity: 2.4 litre tank

Required hole diameter: 35mm

Required supply pressure:

HP Min 1.5 bar Max 3 bar

The hole centre for this product should be a minimum distance of 80mm from wall

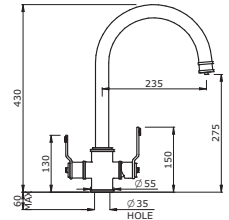

Chrome

Armstrong Mini Instant Hot water and Cold Filtration tap with textured lever handle

Ref. 1833HT CP Chrome **£1455**

Ref. 1833HT NI Polished Nickel **£1528**

Ref. 1833HT PF Pewter **£1602**

Special Finishes **£1712**

English Bronze **£1638**

Capacity: 2.4 litre tank

Required hole diameter: 35mm

Required supply pressure:

HP Min 1 bar Max 5 bar

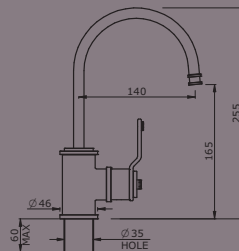

ARMSTRONG FILTER TAPS

The **Armstrong** Filter collection includes a 3 in 1 Filtration model which can be used as the principal tap and simple Filter only tap which is an ideal choice as a secondary tap in the kitchen.

Prices include Filter.

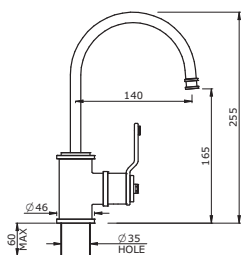

Armstrong Mini Filtration tap with textured lever handle

Ref. 1633HT CP Chrome **£511**

Ref. 1633HT NI Polished Nickel **£528**

Ref. 1633HT PF Pewter **£545**

Special Finishes **£570**

English Bronze **£554**

Required hole diameter: 35mm

Required supply pressure:

HP Min 1 bar Max 5 bar



Chrome

Standard Finishes



Chrome CP



Polished Nickel NI



Pewter PF

Special Finishes

Allow 10 to 12 weeks delivery



Gold IG



Aged Brass AB



English Bronze BZ



Polished Brass BR



Satin Brass SB



Gold

Armstrong sink mixer with Filtration, C spout and textured lever handles

Ref. 1485HT CP

Chrome **£1022**

Ref. 1485HT NI

Polished Nickel **£1090**

Ref. 1485HT PF

Pewter **£1159**

Special Finishes **£1260**

English Bronze **£1192**

Required hole diameter: 35mm

Required supply pressure:

HP Min 1.5 bar Max 3 bar

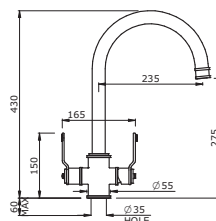

Water Pressure Explained - page 219

FILTER TAPS pure

TAP INTO HEALTHIER GREAT TASTING FILTERED WATER



The filtered water tap is fast becoming a common feature in today's modern kitchen.

The high performance filters transform standard tap water into fresh clean tasting drinking water so efficiently that the filtered water cannot be distinguished from bottled mineral water.

The cost saving is considerable compared to purchasing bottled water and also saves time and energy carrying heavy bottles from the supermarket. Using a filtered tap is also environmentally friendly thus avoiding the disposal of endless plastic bottles.

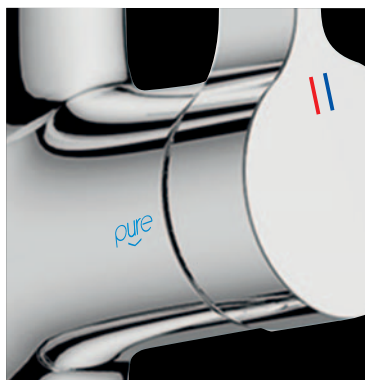

FILTER TAP BENEFITS

TASTE

The Filter removes impurities to give the water a great taste to rival bottled mineral water. The filtration transforms tap water giving a pure untainted taste.

HEALTH

Drinking filtered water with all impurities removed and the healthy minerals left adds to the health-giving properties compared to standard tap water.

CHILLED

Chiller units can further add to the pleasure of filtered refreshing water, simple to fit under the sink giving constant chilled/filtered water.



ENVIRONMENT

Aside from the inconvenience of carrying heavy bottles home from the supermarket, there is the added benefit of not adding to the growing plastic waste epidemic that is choking our planet.

ECONOMY

Why spend a fortune on bottled water when equally good tasting water is simply on tap and virtually free to use.

APPLIANCES

Prolong the life of your steam iron and kettle by filling with filtered water to avoid limescale build-up.

FILTER REPLACEMENT

To maintain a supply of great tasting water it is important to replace the filter after 4000 litres have been used. Filters are easy to replace by a simple twist off and twist on process, no plumbing skill required!

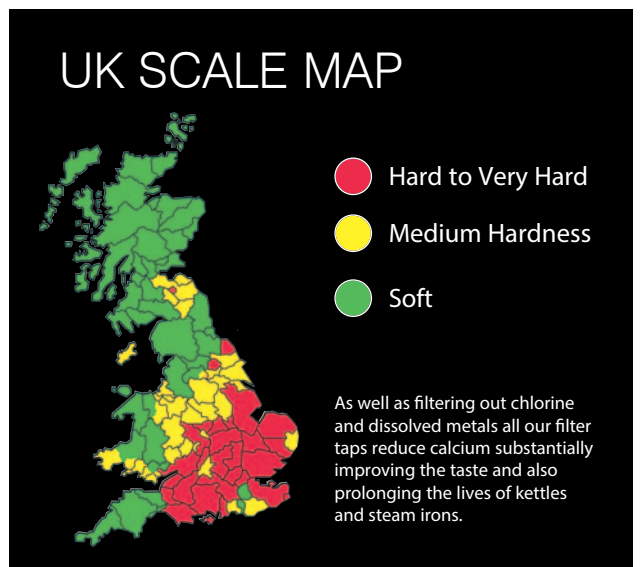

clearwater

FILTER



The **Pure FlowPro** is a digital Filter replacement reminder system with live flow rate.

Included with all Filter Taps.



For chilled filtered water see our **Chiller** on page 209



The Filter

Each Clearwater filter delivers 3800 litres of filtered water at a fraction of the price of bottled water. Untainted by the taste of heavy metals, limescale and chlorine results in fresh, great tasting water straight from the tap.

NSF REG4 Approved

Replacement Cartridges
Ref. P6C1 - £55



MARINER

The synergy of form and function has resulted in a tap with understated elegance and great functionality. The **Mariner's** quiet good looks conceal the latest valve technology - Hot/Cold water is controlled by the stylish lever on the right and cold filtered water is operated by the subtly hidden press-control on the left.

Ref. **MAL10CP** Chrome £336

Ref. **MAL10BN** Brushed Nickel PVD £358

Ref. **MAL10MB** Matt Black £369

Ref. **MAL10BB** Brushed Brass PVD £380

Included: Filter Cartridge, Connectors and Pure FlowPro
WRAS Approved

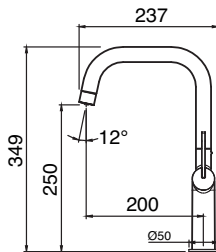

- **PVD COATING**
Helps to withstand surface damage and provides a more hygienic surface
- **CONCEALED FILTER CONTROL**
provides seamless aesthetic minimalism





Filter Taps



Chrome



Brushed Nickel PVD



Matt Black



Brushed Brass PVD



Water Pressure Explained - page 219

FILTER PULL-OUT pure



The **Pure FlowPro** is a digital Filter replacement reminder system with live flow rate. **Included with all Filter Taps.**



For chilled filtered water see our **Chiller** on page 209



ROSETTA

The **Rosetta's** flowing lines provide a truly 21st century aesthetic. This ultra-modern tap is packed with clever tech that allows for great task flexibility.

- Ref. ROL10CP**
Chrome **£336**
- Ref. ROL10BN**
Brushed Nickel PVD **£358**
- Ref. ROL10MB**
Matt Black **£369**
- Ref. ROL10BB**
Brushed Brass PVD **£380**

Included: Filter Cartridge, Connectors and Pure FlowPro WRAS Approved

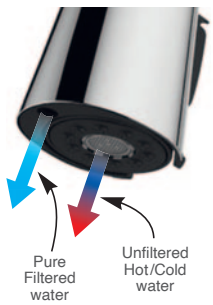
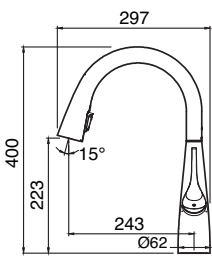

Chrome



Brushed Nickel PVD



Matt Black



Brushed Brass PVD

- **CONCEALED PULL-OUT SPRAYHEAD**
Easy pull-out spray-head is invisibly concealed within the spout
- **TWO-FUNCTION SPRAYHEAD**
Button control allows you to switch from aerated to spray
- **SEPARATE FILTERED WATER OUTLET**
Avoids cross-contamination with mixed water
- **PVD COATING**
Helps to withstand surface damage and provides a more hygienic surface



Black sprayhead is hidden under the concealed pulldown

TOLEDO

The **Toledo** Mixer/Filter tap boasts an understated aesthetic with a pull-out spout discreetly engineered to enhance its minimalist credentials.

Ref. TO2CP

Chrome **£369**

Ref. TO2BN

Brushed Nickel PVD **£425**

Ref. TO2MB

Matt Black **£437**

Ref. TO2BB

Brushed Brass PVD **£437**

Included: Filter Cartridge, Connectors and Pure FlowPro

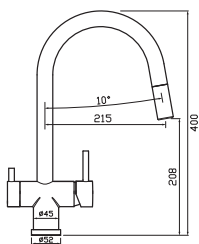

TAP ICONS EXPLAINED



Pull-out Aerated Spray
Increases operating range of the tap supplying a single aerated flow.



Pull-out Dual Flow Spray
Increases operating range of the tap and provides easy switching from aerated flow to needle spray.



Pull-out spray extends to 30cm

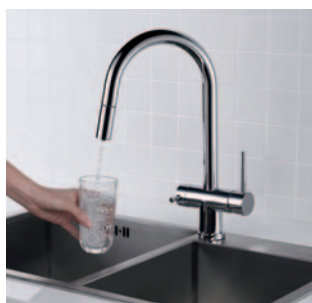

Separate filtered water outlet

Brushed Brass PVD

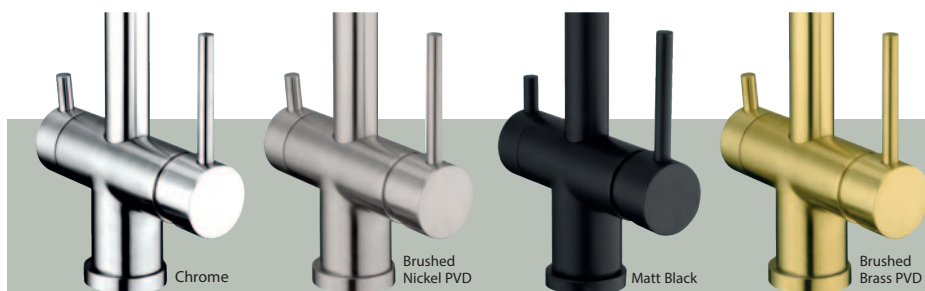

Chrome

Brushed Nickel PVD

Matt Black

Brushed Brass PVD



Water Pressure Explained - page 219

PVD COATING
Helps to withstand surface damage and provides a more hygienic surface

FILTER PRO



The **Pure FlowPro** is a digital Filter replacement reminder system with live flow rate. **Included with all Filter Taps.**



For chilled filtered water see our **Chiller** on page 209

Galex Motion
For the Sensor version of the Galex tap see page 214-215.

CHROME

MATT BLACK



Matt Black

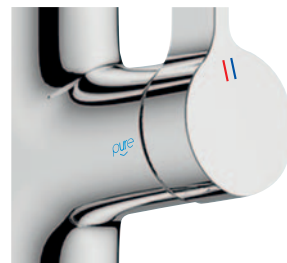

3-Way Lever

The universal 3-way lever operates pure filtered and domestic hot and cold water

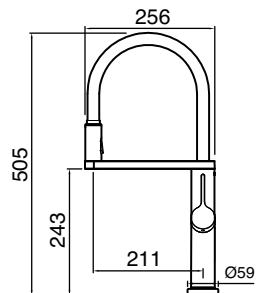

GALEX

The **Galex** is the next generation of Professional taps combining a minimalist design with multiple task possibilities. The single control dispenses standard hot/cold water and great tasting filtered cold water. The detachable showerhead offers 360° flexibility for food prep and rinsing down.

Ref. GAL20CP

Chrome **£369**

Ref. GAL20MB

Matt Black **£403**

Included: Filter Cartridge, Connectors and Pure FlowPro
WRAS Approved



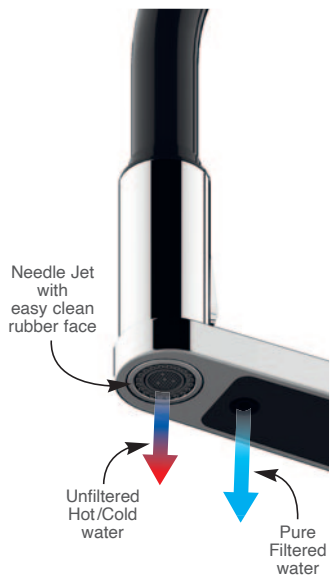

- **EASY-DOCK SPRAYHEAD**
Magnetic docking sprayhead simply lift off to direct flow 360 degrees

- **TWO-FUNCTION SPRAYHEAD**
Button control allows you to switch from aerated to spray

- **SEPARATE WATER OUTLETS**
Avoids cross-contamination mixed water

- **PVD COATING**
Helps to withstand surface damage and provides a more hygienic surface

- **SILICON FLEXIBLE HOSE**
Totally flexible silicon heat resistant easy clean hose



clearwater

FILTER PRO ^{pure}



BRUSHED
NICKEL PVD

CHROME

BRUSHED GUN
METAL PVD



White & Brushed Nickel



Red & Chrome



Grey & Gun Metal

BELLATRIX

The **Bellatrix** is a professional style filter tap offering the ever useful detachable and directional silicon spout which offers two spray modes for rinsing and filling. The swivel retaining arm also contains its own water conduit for filtered water with its outlet neatly positioned behind the main spout. The Bellatrix is supplied as standard with a black silicon hose and there is a choice of white, grey and red hoses that can be purchased separately to colour tone with your kitchen.



Black & Brushed Nickel

HOSE COLOURS

Black (included with tap)

BEWT White £29

BEGT Grey £29

BERT Red £29



The **Pure FlowPro** is a digital Filter replacement reminder system with live flow rate.

Included with all Filter Taps.



For chilled filtered water see our **Chiller** on page 209

Black & Gun Metal

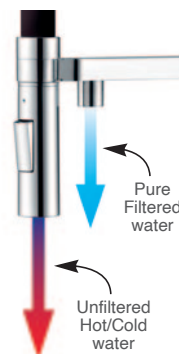
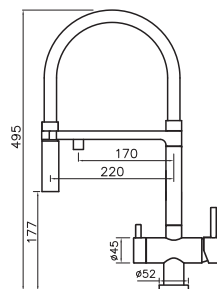

TAP ICONS EXPLAINED



Minimum Operating Water Pressure

See full water pressure guide on page 219.



Professional Dual Flow Spray
360° flexible spout with easy switching from aerated flow to needle spray.

Bellatrix Professional mixer with detachable silicon spout, twin spray head and cold filter.

Ref. BE4CP Chrome/Black £449

Ref. BE5BN Brushed Nickel PVD/Black £489

Ref. BE7GM Gun Metal PVD/Black £489

Included: Filter Cartridge, Connectors and Pure FlowPro



FILTER TRI-SPA



The **Tri-Spa** range of taps are based on the original three lever control design, each lever operates its own waterway and is delightfully simple to operate. The domestic hot and cold are in the usual side positions and the filtered water is controlled by the central lever. All models have separated filtered water conduits to avoid any mixing with unfiltered water.

There are three design choices; the **Stella** for crisp minimalism on these pages, the **Eclipse** for soft flowing lines and the **Krypton** for a more nostalgic style on the following pages.

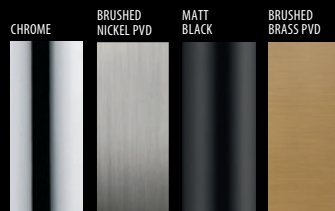

The **Pure FlowPro** is a digital Filter replacement reminder system with live flow rate.

Included with all Filter Taps.

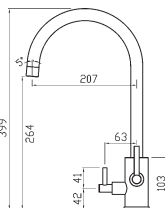
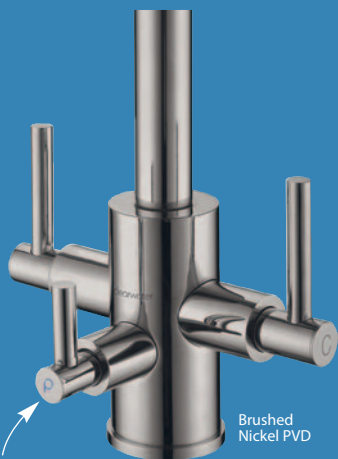
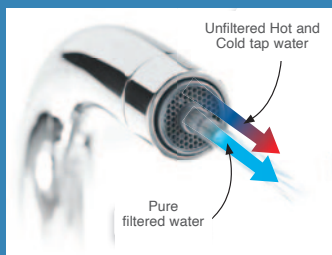

Stella Tri-Spa mixer and cold Filter with 'C' swivel spout.

- Ref. ST2CP** Chrome **£337**
- Ref. ST2BN** Brushed Nickel PVD **£388**
- Ref. ST2MB** Matt Black **£409**
- Ref. ST2BB** Brushed Brass PVD **£409**

Included: Filter Cartridge, Connectors and Pure FlowPro

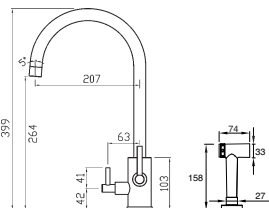

Stella Tri-Spa & Pull-Out Spray Mixer & cold Filter with 'C' swivel spout.

- Ref. STR2CP** Chrome **£437**
- Ref. STR2BN** Brushed Nickel PVD **£502**
- Ref. STR2MB** Matt Black **£528**
- Ref. STR2BB** Brushed Brass PVD **£533**

Included: Filter Cartridge, Connectors and Pure FlowPro





Stella Filter Tap with Modern Pull-Out Spray in Brushed Nickel - see page 262



For chilled filtered water see our **Chiller** on page 209

TAP ICONS EXPLAINED



Minimum Operating Water Pressure
See full water pressure guide on page 219.



Maximum Spout Swivel

Matching Wastes available
see page 158



Water Pressure Explained - page 219

Filter Taps

STELLA FINISHES

PVD COATING
Helps to withstand surface damage and provides a more hygienic surface

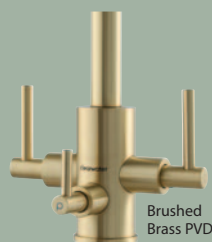
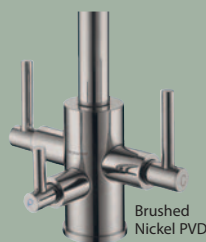

clearwater

FILTER TRI-SPA

pure®

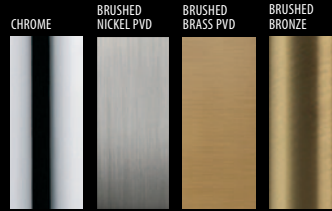

For chilled filtered water see our **Chiller** on page 209

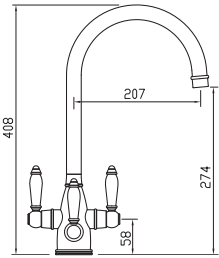

KRYPTON TRI-SPA

Brushed Nickel PVD



Brushed Brass

Krypton Tri-Spa mixer and cold Filter with 'C' swivel spout.

Ref. KR2CP Chrome **£337**

Ref. KR2BN Brushed Nickel PVD **£388**

Ref. KR2BZ Brushed Bronze **£409**

Ref. KR2BB Brushed Brass PVD **£409**

Included: Filter Cartridge, Connectors and Pure FlowPro



KRYPTON FINISHES

PVD COATING Helps to withstand surface damage and provides a more hygienic surface



Chrome



Brushed Nickel PVD



Brushed Bronze



Brushed Brass PVD



The **Pure FlowPro** is a digital Filter replacement reminder system with live flow rate.
Included with all Filter Taps.

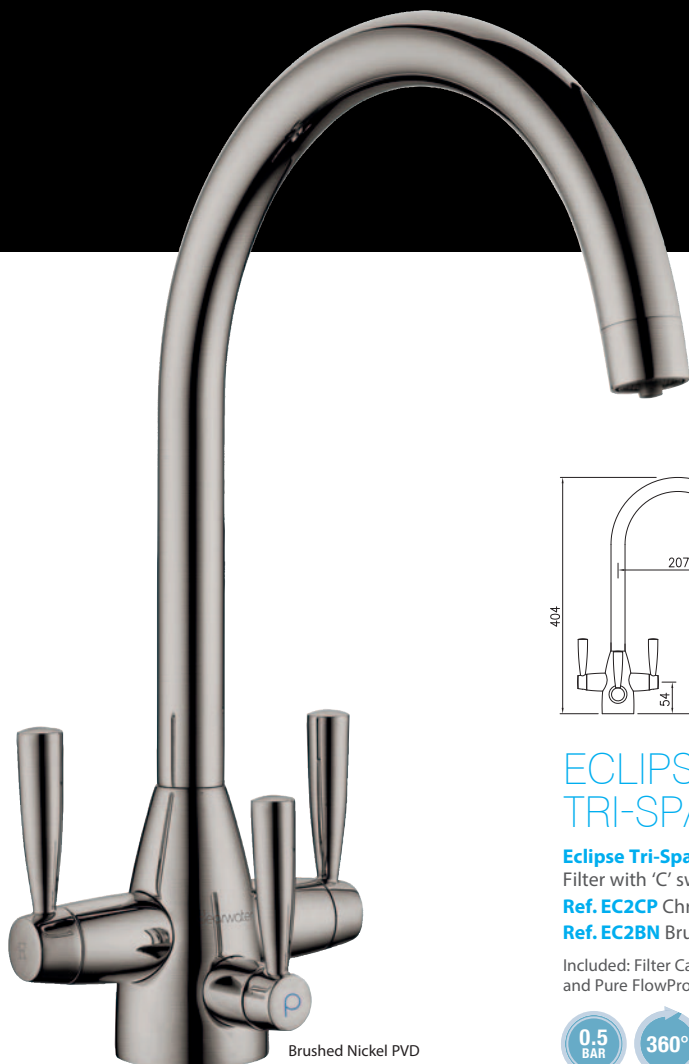

Brushed Nickel PVD

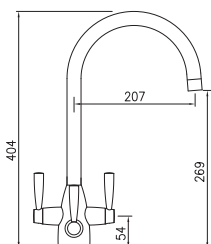

ECLIPSE TRI-SPA

Eclipse Tri-Spa mixer and cold Filter with 'C' swivel spout.

Ref. EC2CP Chrome **£337**

Ref. EC2BN Brushed Nickel PVD **£388**

Included: Filter Cartridge, Connectors and Pure FlowPro



TAP ICONS EXPLAINED



Minimum Operating Water Pressure
 See full water pressure guide on page 219.



Maximum Spout Swivel



Matching Wastes available
 see page 158



Chrome

ECLIPSE FINISHES

PVD COATING
 Helps to withstand surface damage and provides a more hygienic surface

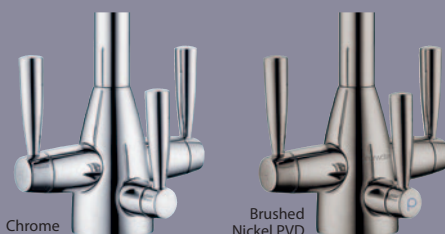

Chrome

Brushed Nickel PVD

FILTER



The **Pure FlowPro** is a digital Filter replacement reminder system with live flow rate.

Included with all Filter Taps.



For chilled filtered water see our **Chiller** on page 209

NESO

An elegant swan neck spout mixer that will suit both contemporary and traditional settings.

Neso mixer and cold Filter with 'C' swivel spout.

Ref. NE2CP Chrome **£298**

Included: Filter Cartridge, Connectors and Pure FlowPro

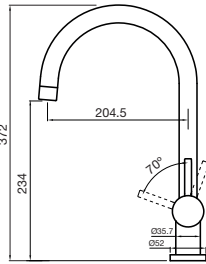

Chrome

ALPHA

The Alpha top lever modern design is a minimalist classic with the bonus of filtered water operated by the side control.

Alpha top lever mixer and cold Filter with swivel spout.

Ref. ALP2BN

Brushed Nickel **£196**

Included: Filter Cartridge, Connectors and Pure FlowPro

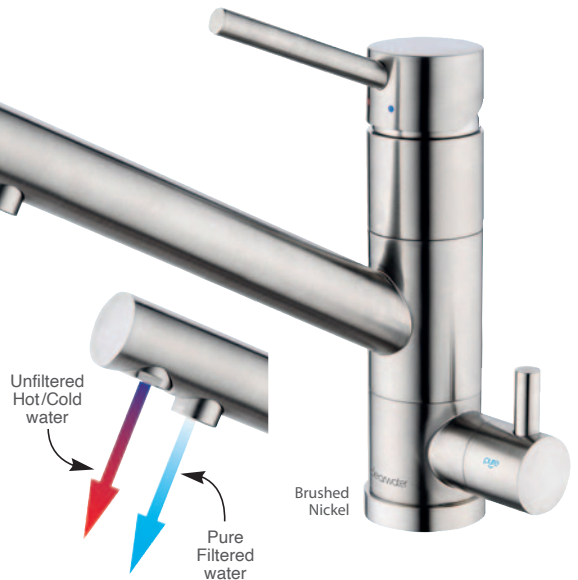
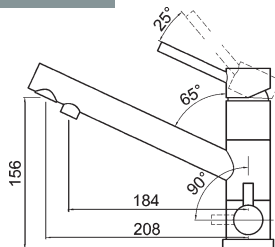

Brushed Nickel

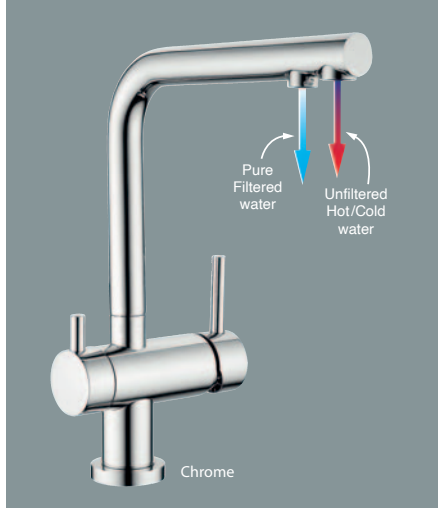

HYDRA

The **Hydra** is very chic 'L' spout mixer available in the usual chrome but also a sophisticated Nero finish to synchronise with matching granite sinks and black appliances.

Hydra mixer and cold Filter with 'L' swivel spout.

Ref. HY2CP
Chrome **£324**

Ref. HY2NE
Chrome/Nero **£380**

Included: Filter Cartridge, Connectors and Pure FlowPro

REG4 Approved

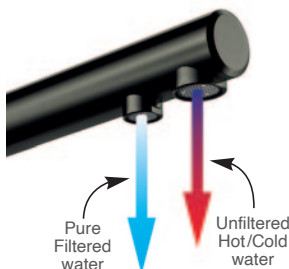
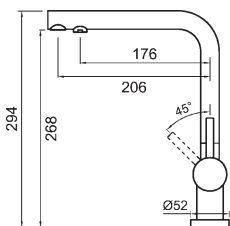

MALIN

Malin mixer and cold Filter with 'L' swivel spout.

Ref. MA2GM
Brushed Gun Metal PVD **£513**

Included: Filter Cartridge, Connectors and Pure FlowPro

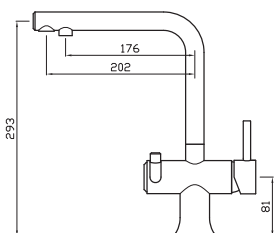

TAP ICONS EXPLAINED



Minimum Operating Water Pressure
See full water pressure guide on page 219.



Maximum Spout Swivel



Water Pressure Explained - page 219

Filter Taps

FILTER pure[®] STAINLESS STEEL



BRUSHED
STAINLESS STEEL

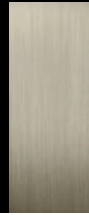

For chilled
filtered water
see our **Chiller**
on page 209



The **Pure FlowPro** is a digital
Filter replacement reminder
system with live flow rate.

Included with all Filter Taps.

AQUARIUS

Aquarius mixer and cold
Filter with 'C' swivel spout.

Ref. AQ2SS Stainless Steel **£427**

Included: Filter Cartridge, Connectors
and Pure FlowPro

REG4 Approved

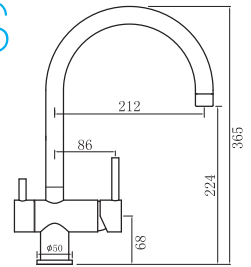

FILTERED WATER SIPHON

This compact siphon delivers cold filtered water **only** and is perfect to work in conjunction with a regular mixer tap.

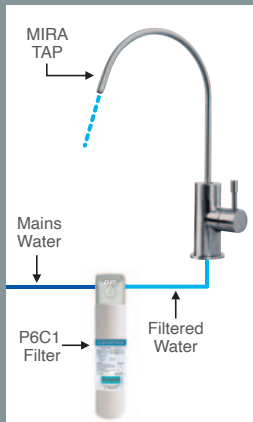

MIRA

Mira single flow cold Filter tap
with 'C' spout.

Ref. MI2SS Stainless Steel **£197**

Included: Filter Cartridge,
Connectors and Pure FlowPro



ZUBEN

A sleek cruciform style filter tap in solid stainless steel providing a wonderful enduring lustre.

Zuben mixer and cold Filter with 'L' swivel spout.

Ref. ZU2SS Stainless Steel **£459**

Included: Filter Cartridge, Connectors and Pure FlowPro

REG4 Approved

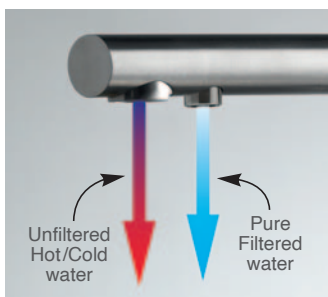
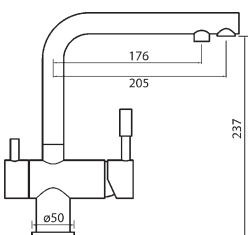

PURE CHILLER 100 pure



For superior tasting water, the **Pure Chiller 100** is an additional feature that can be combined with the Magus 4 or any of our Filter Taps. It has a patented silver turbo clean system which generates a water vortex on the internal walls whenever water is dispensed, so preventing biofilm formation. In addition, the sealed stainless steel cooling chamber is welded together using silver, a material well known for its antibacterial properties.

Thus providing pure crisp chilled water on demand directly from your tap.

- Icebank system for superior chilling
- Simple & quick installation
- Compact design
- Up to 15 litres per hour of chilled water - between 3° and 10° C
- 1.5 bar minimum
- Width 26cm
Depth 23.5cm
Height 40.7cm
- 2 year warranty

Ref. Pure100 **£799**



FILTER TAPS

Although the **Perrin & Rowe** filtration collection may be a new arrival in the filtration market, the technology behind the product derives from the world's first three-way tap, delivering not only hot and cold water but also filtered water through a dedicated waterway – a system that ensures the filtered water is not cross-contaminated by the standard mains hot and cold water.



PHOENICIAN

Phoenician monobloc with cold Filter and porcelain lever handles

Ref. 1460 CP Chrome **£926**

Ref. 1460 NI Polished Nickel **£984**

Ref. 1460 PF Pewter **£1042**

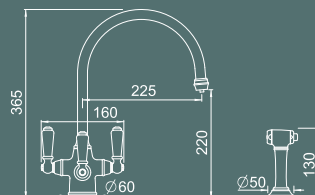

Phoenician monobloc with cold Filter, porcelain lever handles and rinse

Ref. 1560 CP Chrome **£1229**

Ref. 1560 NI Polished Nickel **£1318**

Ref. 1560 PF Pewter **£1406**

Recommended working pressure

RP Min 1.0 bar Max 5.0 bar

Quarter turn ceramic disc

flow control

360° swivel spout

Mounting hole sizes \varnothing 35mm



PARTHIAN

Parthian monobloc with cold
Filter and porcelain lever handles

Ref. 1437 CP Chrome **£906**

Ref. 1437 NI Polished Nickel **£962**

Ref. 1437 PF Pewter **£1020**

Recommended working pressure

HP Min 1.0 bar Max 5.0 bar

Quarter turn ceramic disc flow control

360° swivel spout

Mounting hole sizes \varnothing 35mm

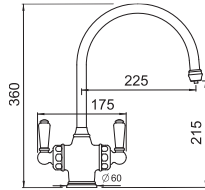

METIS

Metis monobloc with cold
Filter and lever handles

Ref. 1480 CP Chrome **£926**

Ref. 1480 NI Polished Nickel **£984**

Ref. 1480 PF Pewter **£1042**

Recommended working pressure

HP Min 1.0 bar Max 5.0 bar

Quarter turn ceramic disc flow control

360° swivel spout

Mounting hole sizes \varnothing 35mm

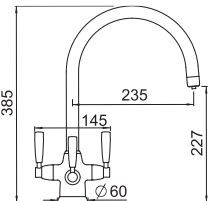



PICARDIE

**Picardie monobloc with cold
Filter and lever handles**

Ref. 1475 CP Chrome **£989**

Ref. 1475 NI Polished Nickel **£1054**

Ref. 1475 PF Pewter **£1119**

Ref. 1475 IG Gold **£1216**

Recommended working pressure

HP Min 1.0 bar Max 5.0 bar

Quarter turn ceramic disc flow control

360° swivel spout

Mounting hole sizes Ø 35mm

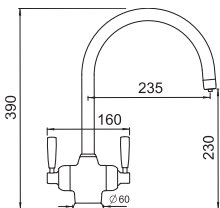
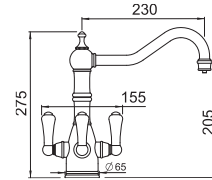

MIMAS

**Mimas monobloc with cold
Filter and lever handles**

Ref. 1435 CP Chrome **£906**

Ref. 1435 NI Polished Nickel **£962**

Ref. 1435 PF Pewter **£1019**

Ref. 1435 IG Gold **£1105**

Recommended working pressure

HP Min 1.0 bar Max 5.0 bar

Quarter turn ceramic disc flow control

360° swivel spout

Mounting hole sizes Ø 35mm







ETRUSCAN

Etruscan monobloc with cold Filter and lever handles

Ref. 1420 CP Chrome **£926**
Ref. 1420 NI Polished Nickel **£984**
Ref. 1420 PF Pewter **£1042**
Ref. 1420 IG Gold **£1130**

Recommended working pressure
HP Min 1.0 bar Max 5.0 bar
 Quarter turn ceramic disc flow control
 360° swivel spout
 Mounting hole sizes Ø 35mm



Close-up of unique Etruscan indices.

Filter Taps



Water Pressure Explained - page 219

SENSOR TAPS

Sensor taps free-up your hands so you can speed through daily chores such as washing, cleaning and food prep whilst maintaining a more hygienic environment. No need to touch the tap when your hands are full or you have been prepping raw meat - just a simple wave of your hand or an object such as a pan or a utensil will activate the sensor to turn the water flow on and a further movement within 10cm of the sensor will turn it off.

These state-of-the-art taps are an invaluable kitchen assistant that will create a more germ-free work zone.

- **INTELLIGENT MOTION TECHNOLOGY**
Reliable touchless on/off operation
- **PRECISE ACTIVATION ZONE**
Utilises state-of-the-art sensor to prevent false activations
- **DUAL OPERATION**
Optional manual and Touchless control
- **BATTERY OPERATED**
No power supply necessary

GALEX MOTION



The **Galex Motion** touchless tap combines beautiful design and smart technology which enables you to speed through tasks at the sink without having to touch the tap thus avoiding the spread of germs. The Motion™ technology will respond by a simple movement of a hand or object. The sensor operates within 10cm to avoid unintentional activation.

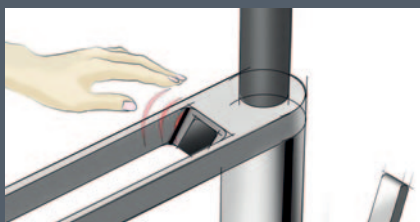

Sensor operated

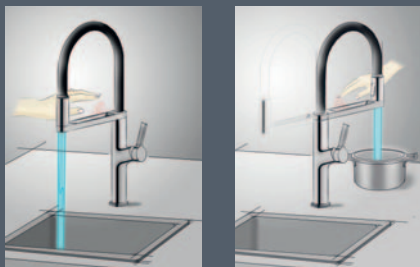

Multi-directional



red dot award 2018 winner

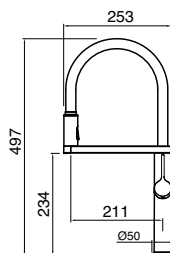

- Ref. GAL10CP** Chrome £356
- Ref. GAL10BN** Brushed Nickel PVD £366
- Ref. GAL10MB** Matt Black £377
- Ref. GAL10BB** Brushed Brass PVD £399

WRAS Approved



Brushed Brass PVD

● PVD COATING

Helps to withstand surface damage and provides a more hygienic surface

● Energy saving cold-start control



Hot and Cold indices on lever



Sensor situated at base of spout



Two function spray-head

- **EASY-DOCK SPRAYHEAD**
Magnetic docking sprayhead simply lift off to direct flow 360 degrees
- **TWO-FUNCTION SPRAYHEAD**
Button control allows you to switch from aerated to spray



Professional Dual Flow Spray
360° flexible spout with easy switching from aerated flow to needle spray.



Cold Start
Energy saving cartridge means when the lever is in the vertical position, it only dispenses cold water and not mixed. Forward rotation avoids the lever hitting the splashback.

AMELIO SENSOR



- BATTERY OPERATED
No power supply necessary
- Energy saving cold-start control

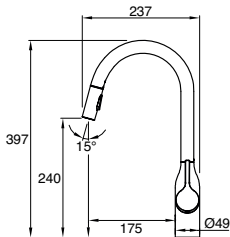

AMELIO PULL-OUT

The **Amelio** is a most elegant tap with flowing lines and versatile functions, including a smooth action pull-out hand spray with dual flow options and a motion sensor positioned at its front base for touchless control when required.

As with all our Sensor taps, water can be controlled both manually and by sensor.

Ref. AML10CP Chrome £323

Ref. AML10BN Brushed Nickel PVD £334

Ref. AML10MB Matt Black £345

Ref. AML10BB Brushed Brass PVD £355

WRAS Approved



PVD COATING
Helps to withstand surface damage and provides a more hygienic surface

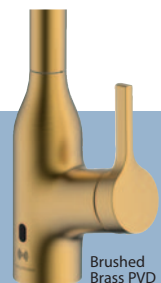
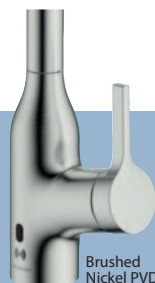

AZIA SENSOR



Matching Wastes
available
see page 158

- BATTERY OPERATED
No power supply necessary
- Energy saving cold-start control



Sensor position

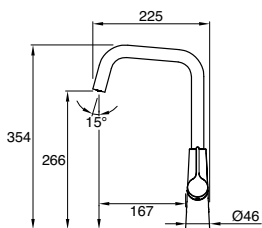

AZIA

The **Azia** has very progressive styling with an asymmetric body design, part curved, part flat with its motion sensor located on the left face - a simple movement within 10cm will activate the flow.

As with all our Sensor taps water can be controlled manually and by sensor.

Ref. AZL10CP Chrome £344

Ref. AZL10BN Brushed Nickel PVD £345

Ref. AZL10MB Matt Black £356

Ref. AZL10BB Brushed Brass PVD £373

WRAS Approved



Matt Black



Chrome

Brushed
Nickel PVD

Matt Black

Brushed
Brass PVD



Modern Taps

Our Modern tap collection has an extensive range of designs from popular minimalism through to iconic funky, exemplified by the newly launched 'Happy' from Gessi. The latest technology has been included with many of our taps providing sensors for flow and temperature control through to the use of coloured LED's to denote the water temperature.

Quality has been our overriding principle when selecting products and all our suppliers are leaders in the tap industry.

We trust you will find from this vast collection the ideal tap for your home.



About Water Pressure

Gravity - it is very important that before you purchase your tap you establish the water pressure in your home. If you have a traditional hot water cylinder the pressure will be determined by gravity only. Measure the height from the bottom of your cold storage tank (usually located in the loft) to your kitchen tap - the longer the drop the more pressure you will have - see table below.

0.1 Bar = 3 foot head of pressure

0.2 Bar = 6 foot head of pressure

0.5 Bar = 15 foot head of pressure

1.0 Bar = 30 foot head of pressure etc

LP 0.1 - 0.49

MP 0.5 - 0.99

HP 1.0 Plus

Combination Boilers - usually provide a good level of pressure - this is usually between 1.5 to 2 bar with an average mains pressure supply coming in to your house.

Look out for our minimum bar guides shown with each tap, use these in conjunction with this table to assist in choosing the right tap for your home.

Cold Start 

Taps with this icon use an innovative energy saving cartridge. This means when the lever is in the vertical position it only dispenses cold water, not mixed as other taps do. This prevents firing the water heater each time you turn on the tap - helping you to conserve energy.

PVD Finish

Ensuring the surface composition is three-times harder, making the surface more resistant to damage.

TWIST & SPRAY®

These taps are fitted with the unique **Twist & Spray** aerator which provides two flow types that can be changed with a simple twist of the flange. The pleasing high quality movement clicks from a non-splash aerated flow to a needle jet-spray that is ideal for jobs such as rinsing plates and food preparation. The needle-jet mode can also generate detergent bubbles far more easily than an aerated flow, particularly in today's water regulated taps.

The Twist & Spray has greatly widened the standard tap's range of abilities in one simple twist.

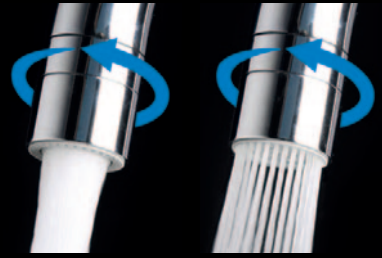

Aerated

Needle Jet



Chrome

SAVITA

The **Savita** boasts sharp cylindrical geometry combined with faultless technology, it's spout incorporates a Twist & Spray Aerator to suit multiple kitchen chores.

Ref. SA2CP Chrome £228

Ref. SA2BN Brushed Nickel PVD £270

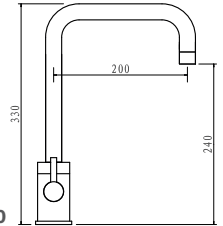

WRAS Approved



Chrome

Brushed Nickel

SIREN

The **Siren** pragmatic assured design, it's spout incorporates a Twist & Spray Aerator to suit multiple kitchen chores.

Ref. S181045CP Chrome £143

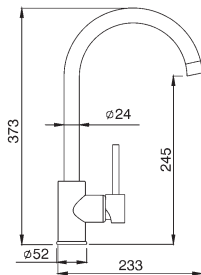

ZODIAC

The **Zodiac's** cosmopolitan design fits with most kitchen types, it comes loaded with the latest tech making them an ideal choice for fault-free longevity. The Z04 is supplied with anti-scale SLC aerator which helps prevent limescale build up.

The Z02 and Z03 incorporate Twist & Spray aerators to suit multiple kitchen chores.

All models are WRAS approved.

- Energy saving cold-start control



Chrome

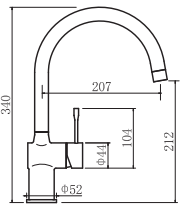
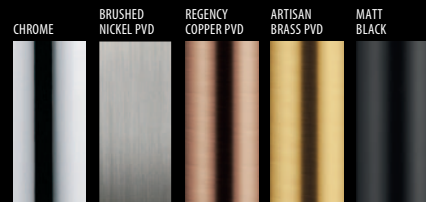

Ref. Z02CP Chrome **£170**

Ref. Z02BN Brushed Nickel PVD **£186**

WRAS Approved

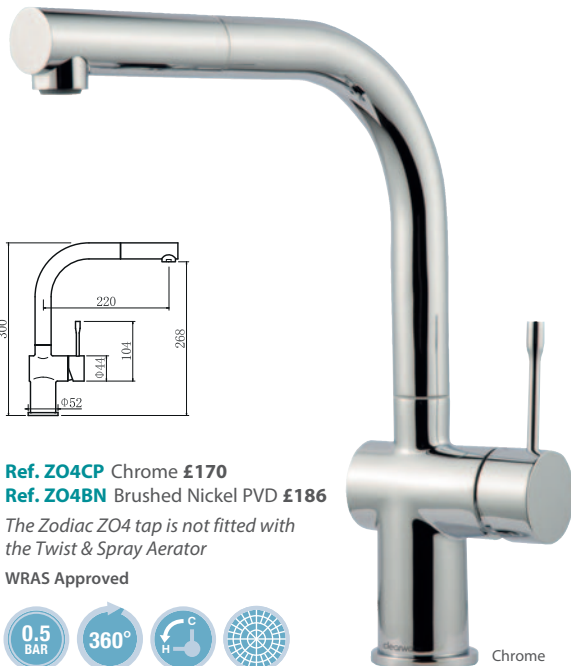

Ref. Z04CP Chrome **£170**

Ref. Z04BN Brushed Nickel PVD **£186**

The Zodiac Z04 tap is not fitted with the Twist & Spray Aerator

WRAS Approved



Chrome

TAP ICON EXPLAINED



Twist & Spray
A simple twist of the spout flange will change the water from aerated to needle jet flow.

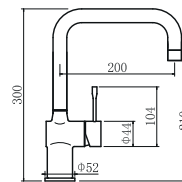
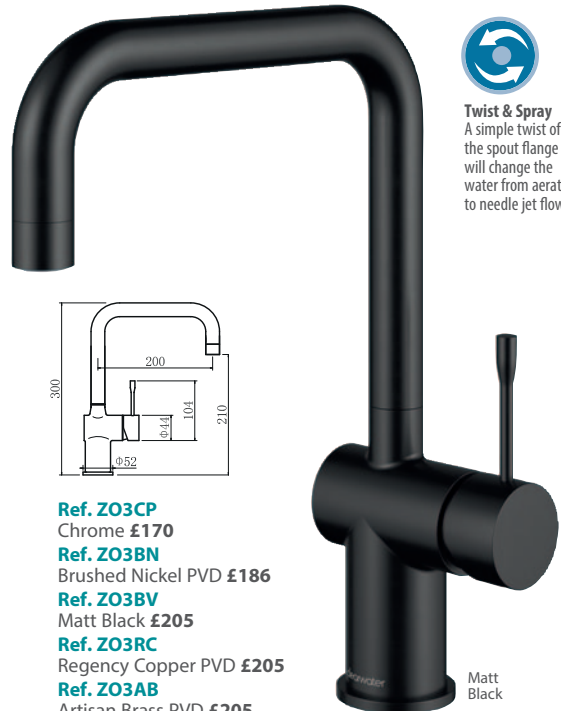

Ref. Z03CP
Chrome **£170**

Ref. Z03BN
Brushed Nickel PVD **£186**

Ref. Z03BV
Matt Black **£205**

Ref. Z03RC
Regency Copper PVD **£205**

Ref. Z03AB
Artisan Brass PVD **£205**

WRAS Approved



Matt Black



Matching Wastes
available
see page 158



TWIST & SPRAY™ TOPAZ

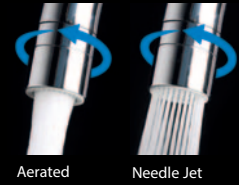

Aerated

Needle Jet



Brushed Brass PVD

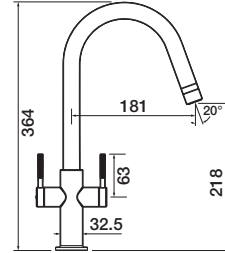

TOPAZ J SPOUT

The **Topaz** boasts a slimline design with minimalist high-set knurled controls. Both spout types incorporate Twist & Spray Aerators to suit multiple kitchen chores.

Ref. TOP20BN
Brushed Nickel PVD **£258**

Ref. TOP20MB
Matt Black **£269**

Ref. TOP20BB
Brushed Brass PVD **£280**

WRAS Approved



Topaz Pull-out
See the pull-out version of the Topaz tap on page 244



Aerated - Brushed Nickel PVD



Needle Jet - Brushed Nickel PVD

PVD COATING

Helps to withstand surface damage and provides a more hygienic surface

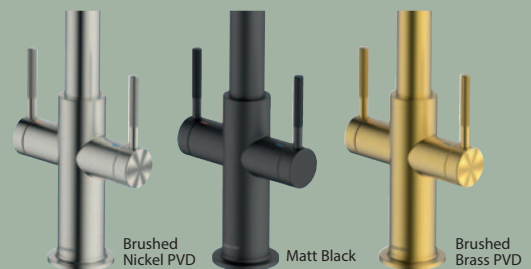

Brushed Nickel PVD

Matt Black

Brushed Brass PVD

BRUSHED NICKEL PVD MATT BLACK BRUSHED BRASS PVD

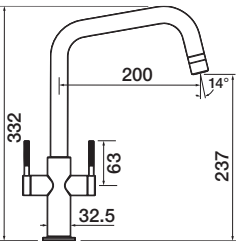

TOPAZ U SPOUT

Ref. TOP10BN
Brushed Nickel PVD £237

Ref. TOP10MB
Matt Black £248

Ref. TOP10BB
Brushed Brass PVD £258

WRAS Approved



TAP ICONS EXPLAINED



Twist & Spray
A simple twist of the spout flange will change the water from aerated to needle jet flow.



Minimum Operating Water Pressure
See full water pressure guide on page 219.



Maximum Spout Swivel



Matching Wastes available
see page 158



Water Pressure Explained - page 219

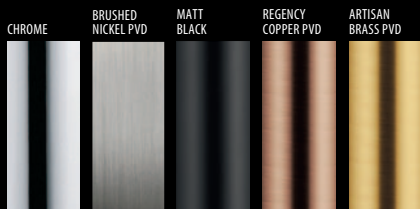

TWIST & SPRAY® ROCOCO

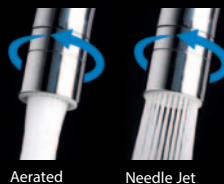

Rococo tap with Modern Pull-Out Spray in Brushed Brass - see page 262

ROCOCO

The **Rococo** is an uncompromising cylindrically shaped tap that offers urban chic in buckets, it's spout incorporates a Twist & Spray Aerator to suit multiple kitchen chores.

The Twist & Spray has greatly widened the standard tap's range of abilities in one simple twist.

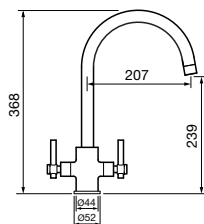

ROCOCO

- Ref. ROC2CP** Chrome **£247**
- Ref. ROC2BN** Brushed Nickel PVD **£297**
- Ref. ROC2MB** Matt Black **£297**
- Ref. ROC2RC** Regency Copper PVD **£297**
- Ref. ROC2AB** Artisan Brass PVD **£297**

WRAS Approved

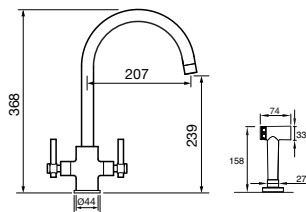

ROCOCO & PULL-OUT SPRAY

- Ref. ROR2CP** Chrome **£347**
- Ref. ROR2BN** Brushed Nickel PVD **£411**
- Ref. ROR2MB** Matt Black **£416**
- Ref. ROR2AB** Artisan Brass PVD **£421**

WRAS Approved



PVD COATING
Helps to withstand surface damage and provides a more hygienic surface

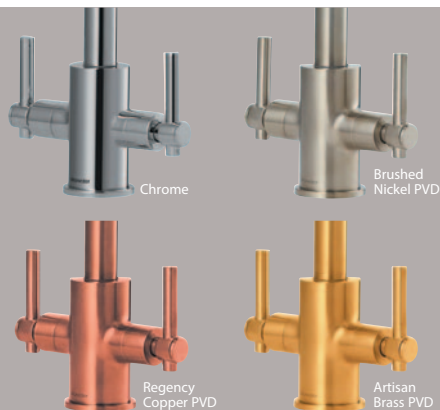

Matt Black

Regency Copper PVD

Artisan Brass PVD

TUTTI



Matt Black

TAP ICONS EXPLAINED



Twist & Spray
A simple twist of the spout flange will change the water from aerated to needle jet flow.



Minimum Operating Water Pressure
See full water pressure guide on page 219.



Maximum Spout Swivel



Artisan Brass PVD

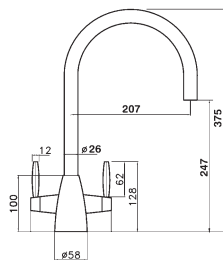

TUTTI

The **Tutti** features tapering base and controls that exude a simple charm, it's spout incorporates a Twist & Spray Aerator to suit multiple kitchen chores.

- Ref. TU81073CP** Chrome **£241**
- Ref. TU81073BS** Brushed Nickel PVD **£259**
- Ref. TU81073BV** Matt Black **£259**
- Ref. TU81073RC** Regency Copper PVD **£259**
- Ref. TU81073AB** Artisan Brass PVD **£259**

WRAS Approved



PVD COATING
Helps to withstand surface damage and provides a more hygienic surface

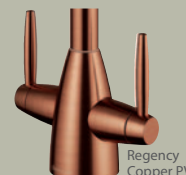
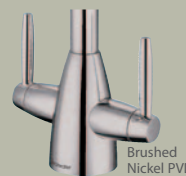

TWIST & SPRAY[®] DAVINA

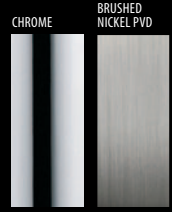
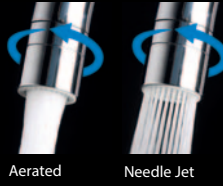

Chrome

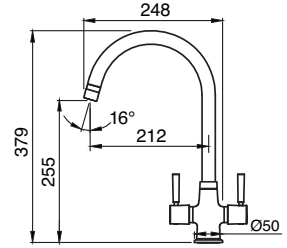

DAVINA

The **Davina** will suit most kitchen styles with its subtle retro styling its spout incorporates a Twist & Spray Aerator to suit multiple kitchen chores.

Ref. DA20CP

Chrome **£224**

Ref. DA20BN

Brushed Nickel PVD **£234**

WRAS Approved



Brushed Nickel PVD

ALZIRA

The **Alzira's** contemporary design with its fluid soft architecture allow it to be at home in both modern and traditional interiors. The colour choices and spout style options make sure this great tap can match to most tastes.



Chrome



Brushed Nickel



Brushed Copper



Brushed Copper



Matching Wastes available see page 158



Chrome

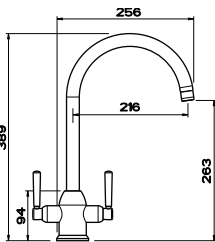

Ref. ALZCP Chrome £261

Ref. ALZBS Brushed Nickel £293

Ref. ALZBC Brushed Copper £303

WRAS Approved



Ref. CAMCP
Chrome £261

Ref. CAMBS
Brushed Nickel £293

Ref. CAMBC
Brushed Copper £303

WRAS Approved

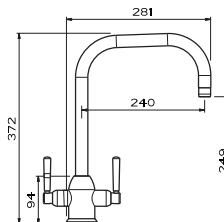

Dual Flow
Keeps the flow of hot and cold water separate in the tap Spout.

JUNO



Matching Wastes available see page 158

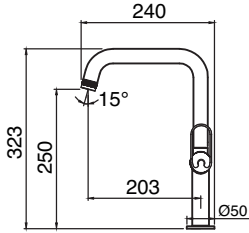

JUNO

The **Juno** boasts a slimline modern design with high-set controls, its precision construction and the latest valve technology will ensure faultless service. This progressive tap announces its industrial aesthetics with a futuristic control handle and knurling on the valve cover. The Juno is available in four fabulous finishes to coordinate or contrast with your choice of kitchen fittings.

Ref. JUL10CP Chrome £185

Ref. JUL10BN Brushed Nickel PVD £205

Ref. JUL10MB Matt Black £215

Ref. JUL10BB Brushed Brass PVD £225

WRAS Approved



- **PVD COATING**
Helps to withstand surface damage and provides a more hygienic surface
- **SLC AERATOR**
Offers anti-limescale features, has a rubber face to prevent scale amalgamation
- **Energy saving cold-start control**



Brushed Brass PVD



Chrome

Brushed Nickel PVD

Matt Black

Brushed Brass PVD

PIONEER

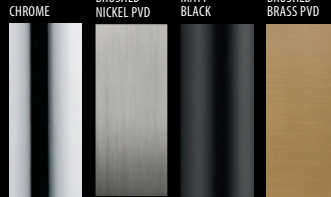

Matching Wastes available see page 158



Pioneer Pull-Out
See the pull-out version of the Pioneer tap on page 248.



Brushed Nickel PVD

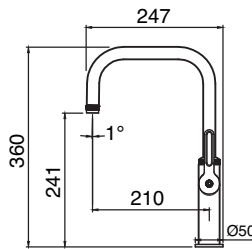

PIONEER

The **Pioneer** taps boast urban good looks with edgy industrial elements – a perfect fit for the warehouse apartment look. Distinct features include knurled components and retro steam-valve controls.

- Ref. PIL20CP** Chrome £185
- Ref. PIL20BN** Brushed Nickel PVD £205
- Ref. PIL20MB** Matt Black £215
- Ref. PIL20BB** Brushed Brass PVD £225

WRAS Approved



TAP ICONS EXPLAINED



Minimum Operating Water Pressure
See full water pressure guide on page 219.



Maximum Spout Swivel



Cold Start
Energy saving cartridge means when the lever is in the vertical position, it only dispenses cold water and not mixed. Forward rotation avoids the lever hitting the splashback.



The Cascade SLC aerator offers anti-limescale features, with a rubber face to prevent scale amalgamation, simple to clean with just a gentle rub.



Chrome



Brushed Nickel PVD



Matt Black



Brushed Brass PVD

- **PVD COATING**
Helps to withstand surface damage and provides a more hygienic surface
- **Energy saving cold-start control**



Levant Pull-out
The Levant is available in a versatile Pull-out version see page 242.

LEVANT



Matching Wastes available
see page 158

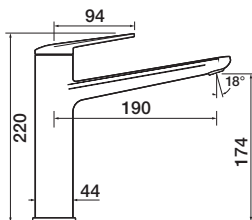

LEVANT

The **Levant's** Swiss architectural design provides effortless good looks that perfectly suit pairing with undermount sinks for sleek minimalism. The robust structure features a beautifully sculptured broad spout with a wide blade control lever that compliments the Levant's design ethos.

Ref. LEV10CP Chrome £215

Ref. LEV10BN Brushed Nickel PVD £226

Ref. LEV10MB Matt Black £237

Ref. LEV10BB Brushed Brass PVD £248

WRAS Approved



Chrome



Brushed Brass PVD



Levant's unique wide blade control lever



Levant Aerator
Slim Air Cascade with adjustable tilting plate (SSR) and Smart Lime Cleaning (SLC)

PVD COATING
Helps to withstand surface damage and provides a more hygienic surface



Chrome



Brushed Nickel PVD



Matt Black



Brushed Brass PVD

TAKU

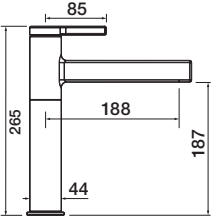
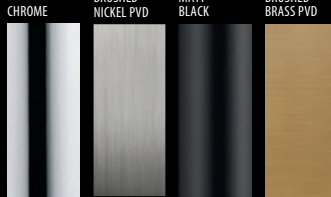

TAKU

The **Taku's** unique design elements, include a vertical linear swivel spout that produces an attractive blade shaped water flow. The top control has an attractive slim profile that compliments the Taku's quirky minimalist qualities.

- Ref. TAK10CP** Chrome £204
- Ref. TAK10BN** Brushed Nickel PVD £215
- Ref. TAK10MB** Matt Black £226
- Ref. TAK10BB** Brushed Brass PVD £237

WRAS Approved



PVD COATING
Helps to withstand surface damage and provides a more hygienic surface

Modern Taps



Black & Brushed Brass PVD

- **PVD COATING**
Helps to withstand surface damage and provides a more hygienic surface
- **SLC AERATOR**
Offers anti-limescale features, has a rubber face to prevent scale amalgamation
- **Energy saving cold start control**



Chrome



Brushed Nickel PVD



Brushed Brass PVD

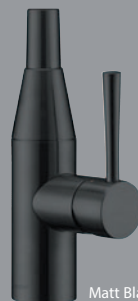

Matt Black



Red RT

Grey GT



White WT

Black Supplied with Tap

MORPHO



The **Morpho** is an ideal choice of tap for multi-tasking with its Flex & Stay spout. This unique spout can be bent and shaped and will remain frozen in position so that the spray can be directed precisely, leaving hands free for the task in hand. The spout can be pulled low into the sink for food preparation and swept around the walls of the sink for rinsing down, making the Morpho a worthy kitchen assistant.

Available in Chrome, Brushed Nickel, Brushed Brass and Matt Black with a choice of four stylish silicon spout colours for complimenting the kitchen colour scheme.



Matching Wastes available
see page 158

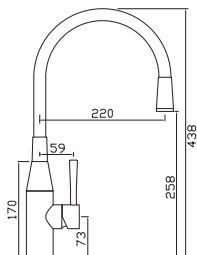

CHROME

BRUSHED
NICKEL PVDMATT
BLACKBRUSHED
BRASS PVD

Ref. MO2CP**

Chrome/Black £230

Ref. MO2BN**

Brushed Nickel PVD/Black £249

Ref. MO2BB**

Brushed Brass PVD/Black £269

Ref. MO2MB**

Matt Black/Black £269

REG4 Approved



Hose Colours

The Morpho is supplied with a Black silicon hose, Red, Grey and White hoses are available at an extra charge.

● **RT** Red Hose £29

● **GT** Grey Hose £29

○ **WT** White Hose £29

(** add hose colour suffix if required)



TAP ICONS EXPLAINED



Cold Start

Energy saving cartridge means when the lever is in the vertical position, it only dispenses cold water and not mixed.

Forward rotation avoids the lever hitting the splashback.



The Cascade SLC aerator offers anti-limescale features, with a rubber face to prevent scale amalgamation, simple to clean with just a gentle rub.



Water Pressure Explained - page 219



Brushed Brass PVD

LORETO

The **Loreto's** excellent credentials belie a very economical pricing level. The minimalist design has been achieved using a 'less is more' design brief resulting in a clean and uncluttered aesthetic. The twin lever operation provides precise water and temperature control and add to the Loreto's symmetrical design. Choose from five fabulous warm and cool metal finishes including a very chic black; these elegant finishes can offer sophisticated colour coordination that truly elevate 'the look'!

Only the highest quality valves and materials are used in the Loreto construction and every tap is backed up with a full five year warranty.

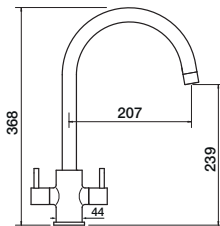

- Ref. LOR10CP** Chrome **£140**
- Ref. LOR10BN** Brushed Nickel PVD **£155**
- Ref. LOR10BB** Artisan Brass PVD **£155**
- Ref. LOR10RC** Regency Copper PVD **£155**
- Ref. LOR10MB** Matt Black **£155**

WRAS Approved

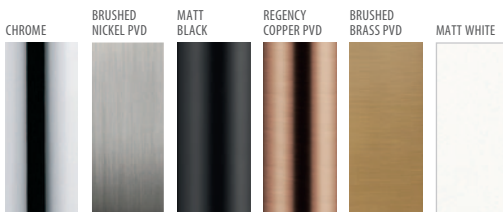

Matt Black

AUVA

The **Auva** twin lever monobloc has an ultra-modern tall profile with smart high-set lever control.

Auva twin lever monobloc with 'C' swivel spout.

- Ref. AU2CP** Chrome **£198**
- Ref. AU2BN** Brushed Nickel PVD **£215**
- Ref. AU2MB** Matt Black **£238**
- Ref. AU2BC** Regency Copper PVD **£238**
- Ref. AU2BB** Brushed Brass PVD **£238**
- Ref. AU2WH** Matt White **£238**

REG4 Approved

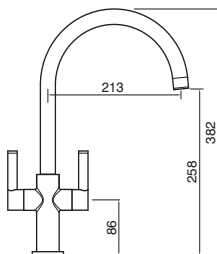

JOVIAN

The **Jovian's** beautifully simple shape lends itself for contemporary settings and can be chosen with two different spout styles.



See also the Jovian Professional on page 257



Matt White

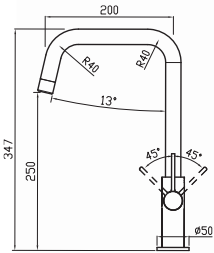
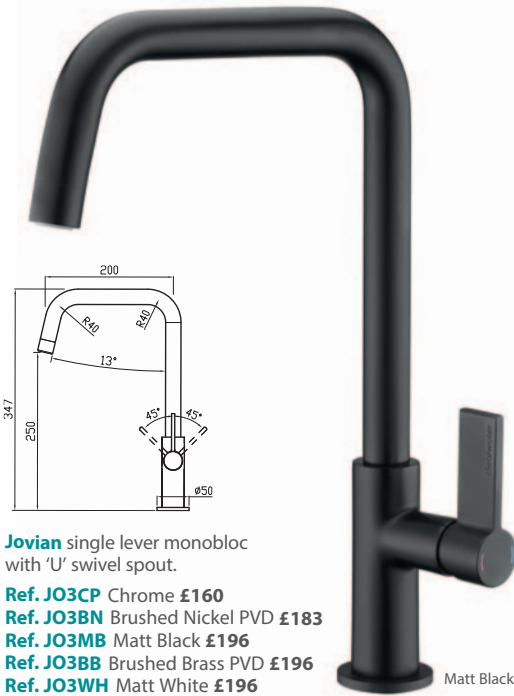

Jovian single lever monobloc with 'U' swivel spout.

- Ref. JO3CP** Chrome **£160**
- Ref. JO3BN** Brushed Nickel PVD **£183**
- Ref. JO3MB** Matt Black **£196**
- Ref. JO3BB** Brushed Brass PVD **£196**
- Ref. JO3WH** Matt White **£196**

Matt Black

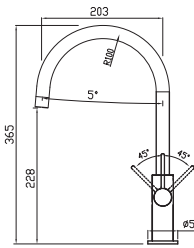

Jovian single lever monobloc with 'C' swivel spout.

- Ref. JO4CP** Chrome **£160**
- Ref. JO4BN** Brushed Nickel PVD **£183**
- Ref. JO4MB** Matt Black **£196**
- Ref. JO4BB** Brushed Brass PVD **£196**
- Ref. JO4WH** Matt White **£196**



TAP ICONS EXPLAINED



Minimum Operating Water Pressure
See full water pressure guide on page 219.



The Cascade SLC aerator offers anti-limescale features, with a rubber face to prevent scale amalgamation, simple to clean with just a gentle rub.



Chrome

Brushed Nickel PVD

Matt Black

Brushed Brass PVD

Matt White

QUARSIL® COLOURS ELARA

POLAR (PO) ONYX (ON) MOONSTONE (MS) NERO (NE) CROMA (CR)



Add colour suffix when ordering

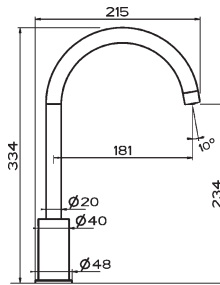

ELARA

The **Elara** is available in three metal finishes and in five Quarsil colours perfectly matched to our Quarsil granite sink collection.

Ref. CW02590CP Chrome **£130**

Ref. CW02590BN Brushed Nickel **£162**

Ref. CW02590BC Brushed Copper **£203**

Ref. CW02590CP** Chrome/Quarsil **£151**

(** add colour suffix)

WRAS Approved



MIRAM



Matching Wastes available see page 158



Polar/Brushed Nickel



Onyx/Chrome



Moonstone/Brushed Nickel



Nero/Chrome



Croma/Brushed Nickel



Chrome/Nero

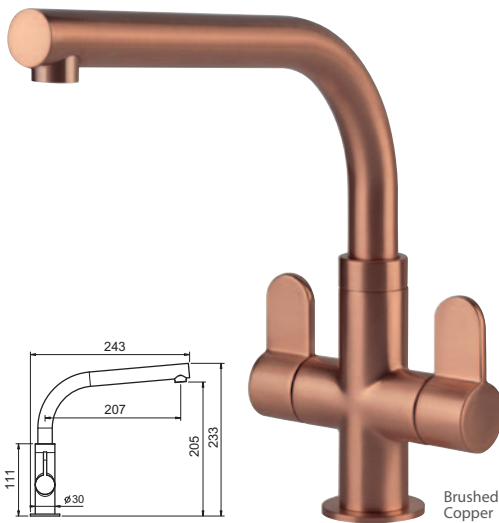

Brushed Copper

TAP ICONS EXPLAINED



Minimum Operating Water Pressure
See full water pressure guide on page 219.



Maximum Spout Swivel

MIRAM

The Miram is an attractive compact tap designed to perfectly colour match Quarsil sinks, also available in an edgy brushed copper.

Ref. MIR2BC Brushed Copper **£284**

Ref. MIR2CP** Chrome/Quarsil **£193**

Ref. MIR2BN** Brushed Nickel/Quarsil **£218**

(* add colour suffix)

WRAS Approved



Water Pressure Explained - page 219

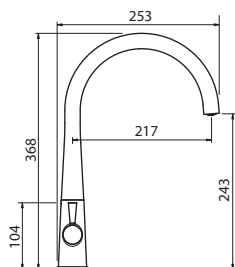

CORONA

An elegant tap with striking tapered levers.

Ref. COR2CP

Chrome **£180**

Ref. COR2BN

Brushed Nickel **£206**



VEGAS

An understated pedestal type mixer with a restrained minimalism.

Ref. VEGCP

Chrome **£274**

WRAS Approved

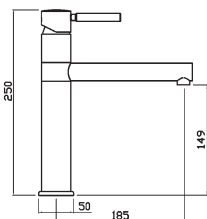

PULSAR

The Pulsar is on trend with its high-set paddle controls.

Ref. PU2CP Chrome **£220**

Ref. PU2BN Brushed Nickel **£248**

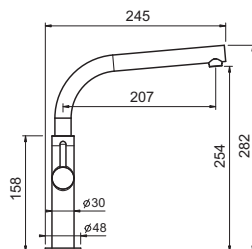

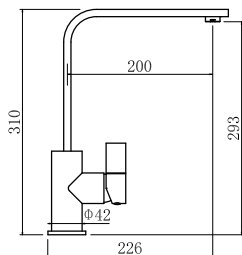
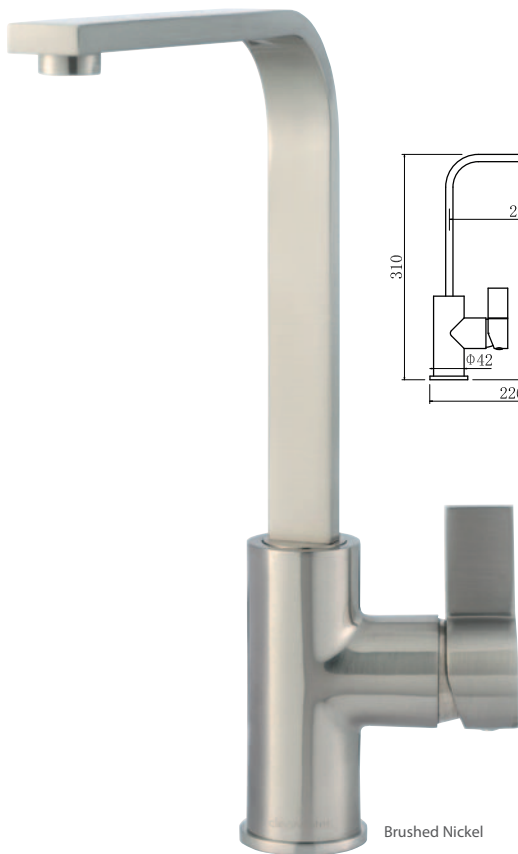

SHERATAN

The **Sheratan** combines a tubular body with a rectangular spout to create very on trend tap architecture.

Ref. SH2CP Chrome **£197**

Ref. SH2BN Brushed Nickel PVD **£215**



Brushed Nickel

TAP ICONS EXPLAINED



Minimum Operating Water Pressure
See full water pressure guide on page 219.



Maximum Spout Swivel



Cold Start
Energy saving cartridge means when the lever is in the vertical position, it only dispenses cold water and not mixed. Forward rotation avoids the lever hitting the splashback.



The Cascade SLC aerator offers anti-limescale features, with a rubber face to prevent scale amalgamation, simple to clean with just a gentle rub.

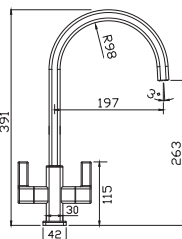
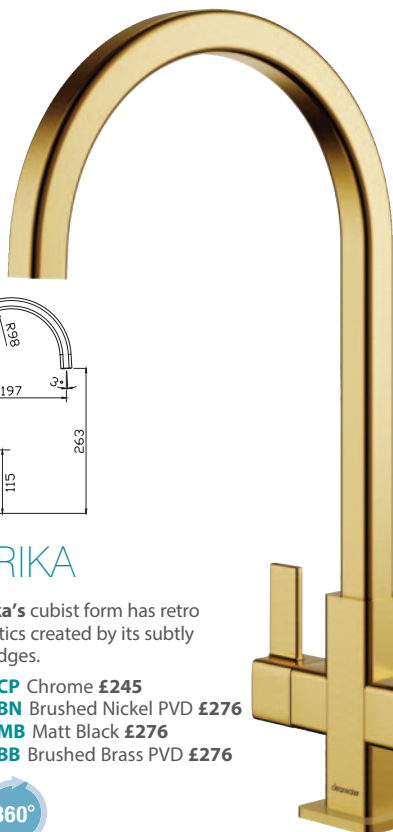

CHERIKA

The **Cherika's** cubist form has retro characteristics created by its subtly softened edges.

Ref. CHE2CP Chrome **£245**

Ref. CHE2BN Brushed Nickel PVD **£276**

Ref. CHE2MB Matt Black **£276**

Ref. CHE2BB Brushed Brass PVD **£276**



Brushed Brass PVD

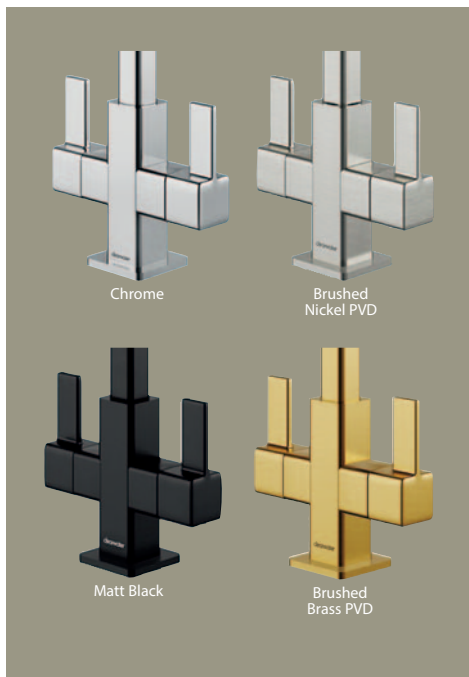

Chrome

Brushed Nickel PVD

Matt Black

Brushed Brass PVD



Brushed Nickel

AURIGA

The **Auriga** has a modern slimline tubular design with a contrasting paddle lever. Also available as pull-outs - see page 239.

Ref. CW00114CP
Chrome **£174**

Ref. CW00114BN
Brushed Nickel **£209**

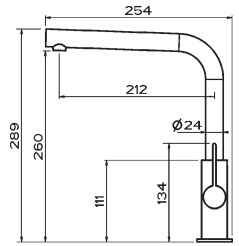

Chrome

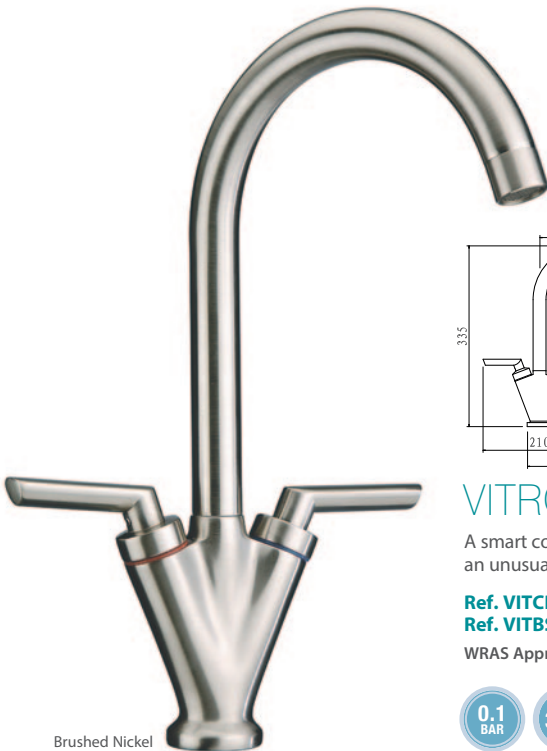

Brushed Nickel

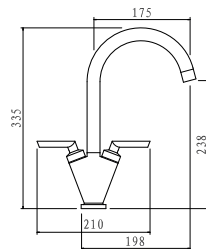

VITRO

A smart compact lever tap with an unusual 'V' shaped body.

Ref. VITCP Chrome **£132**
Ref. VITBS Brushed Nickel PVD **£142**

WRAS Approved



ROSSI

A modern twist on the classic cross head mixer.

Ref. RO2CP Chrome **£139**
Ref. RO2BN Brushed Nickel **£175**

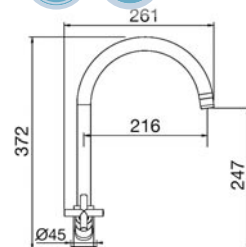



Brushed Nickel

ULTRA

An old favourite - the original cruciform monobloc.

Ref. **ULTCP** Chrome **£132**
Ref. **ULTBS** Brushed Nickel PVD **£142**

WRAS Approved

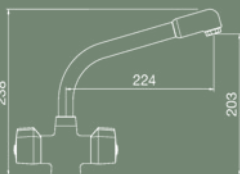

Chrome

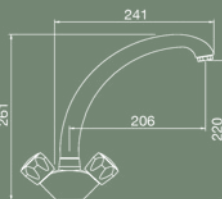

STUDIO

The **Studio** is a classic design that has proved its solid reliability for over twenty years.

Ref. **STUCP** Chrome **£138**

WRAS Approved

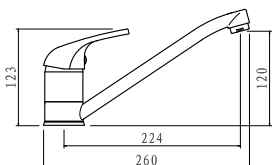

CRETA

A most popular tap at a great price, available with two flow rates; a standard flow and a water-saving regulated flow which is Sustainable Build Compliant.

Ref. **27113CP** Chrome **£98**
Ref. **27113BS** Brushed Nickel PVD **£113**
Ref. **27113MB** Matt Black **£98**

WRAS Approved



Breeam Sustainable Build Compliant

Ref. **27113RCP** Chrome **£123**
Ref. **27113RBS** Brushed Nickel PVD **£142**

Regulated to 4 ltrs per minute

WRAS Approved

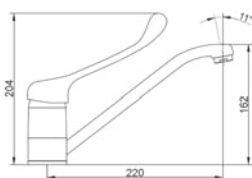

DORMAN

The **Dorman's** extra long control lever is an aid to one's reach and also helpful when hand dexterity is limited.

Ref. **DORCP** Chrome **£174**

WRAS Approved



Dual Flow
Keeps the flow of hot and cold water separate in the tap Spout.



The Cascade SLC aerator offers anti-limescale features, with a rubber face to prevent scale amalgamation, simple to clean with just a gentle rub.



PULL-OUT

The pull-out spout is fast becoming a must-have tap for performing tasks other than simply washing-up. They are a valuable aid for rinsing down the sink after use, washing vegetables and filling large pots.

The next generation models are also available on the following pages with twin-flow spouts that can deliver standard aerated flow for filling and needle-jet spray for rinsing.

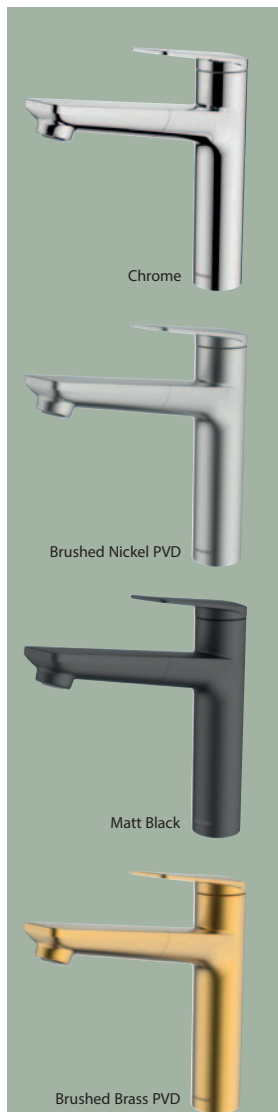

PVD COATING
Helps to withstand surface damage and provides a more hygienic surface

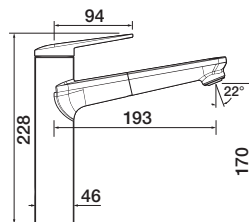

LEVANT PULL-OUT

The **Levant Pull-Out** mixer is a Swiss design masterpiece that gives a cool presence in the kitchen, it's subtly concealed pull-out spout extends its reach by 40cm for multi-tasking and smoothly retracts to transform back to its cool statuesque state.

- Ref. LEV20CP** Chrome £269
- Ref. LEV20BN** Brushed Nickel PVD £280
- Ref. LEV20MB** Matt Black £291
- Ref. LEV20BB** Brushed Brass PVD £302

WRAS Approved



- **AERATOR**
Cascade SLC
- **EXTENSION**
Pull-out handset extends to 40cm





Matching Wastes available
see page 158



Levant
See the non pull-out version of the Levant tap on page 230.

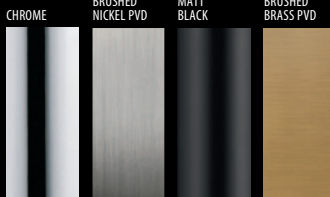

TAP ICONS EXPLAINED



Pull-out Aerated Spray
Increases operating range of the tap supplying a single aerated flow.



Pull-out Dual Flow Spray
Increases operating range of the tap and provides easy switching from aerated flow to needle spray.



Minimum Operating Water Pressure
See full water pressure guide on page 219.



Maximum Spout Swivel



The **Cascade SLC** aerator offers anti-limescale features, with a rubber face to prevent scale amalgamation, simple to clean with just a gentle rub.



Chrome

LARISSA

The **Larissa** has a very purposeful dual flow hand set with a smart sprung top section to operate the flow.

Ref. LA2CP
Chrome **£234**

Ref. LA2BN
Brushed Nickel PVD **£254**

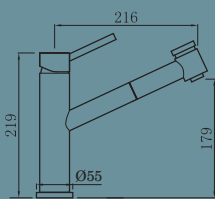

Chrome

clearwater



Topaz
See the non pull-out version of the Topaz tap on page 222.



PULL-OUT TOPAZ



Brushed Nickel PVD

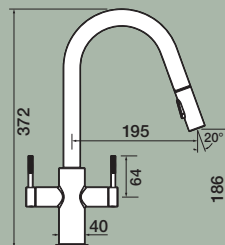

TOPAZ PULL-OUT

The slim form of the **Topaz** has a poised, ready for action stance that is very appealing. The high-set controls are a pleasure to use with their unique knurled controls, whilst the dual-flow handspray has an assured smooth pull-out movement that will multitask with ease.

Ref. TOP30BN
Brushed Nickel PVD **£302**

Ref. TOP30MB
Matt Black **£312**

Ref. TOP30BB
Brushed Brass PVD **£323**

WRAS Approved



- **TWO-FUNCTION SPRAY-HEAD**
Button allows you to switch from aerated flow to needle jet spray – ideal for rinsing down and generating detergent foam.

- **EXTENSION**
Pull-out handset extends to 60cm

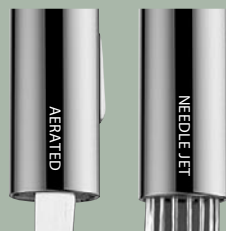

PVD COATING
Helps to withstand surface damage and provides a more hygienic surface



Brushed Nickel PVD

Matt Black

Brushed Brass PVD



Matching Wastes available see page 158

KIRA

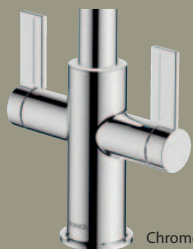

Chrome

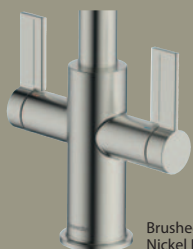

Brushed Nickel PVD



Matt Black

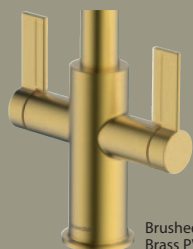

Brushed Brass PVD

- **PVD COATING**
Helps to withstand surface damage and provides a more hygienic surface
- **TWO-FUNCTION SPRAY-HEAD**
Button allows you to switch from aerated flow to needle jet spray – ideal for rinsing down and generating detergent foam.
- **EXTENSION**
Pull-out handset extends to 60cm



Chrome

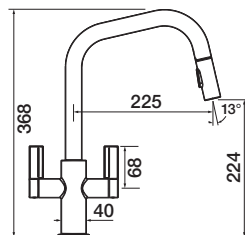

KIRA PULL-OUT

The **Kira** combines a pragmatic design with constrained minimalism. This ultra-modern tap provides easy to operate high-set controls and an indispensable pull-out handset with dual flow capability.

U Spout

Ref. KIR20CP Chrome £269
Ref. KIR20BN Brushed Nickel PVD £291

WRAS Approved

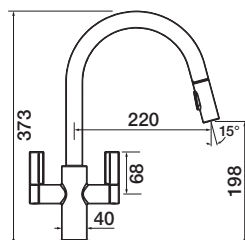

KIRA PULL-OUT

C Spout

Ref. KIR30CP Chrome £269
Ref. KIR30BN Brushed Nickel PVD £291
Ref. KIR30MB Matt Black £312
Ref. KIR30BB Brushed Brass PVD £323

WRAS Approved



Matt Black

TAP ICONS EXPLAINED



Pull-out Dual Flow Spray
Increases operating range of the tap and provides easy switching from aerated flow to needle spray.



Minimum Operating Water Pressure
See full water pressure guide on page 219.



Maximum Spout Swivel

clearwater



PULL-OUT KARUMA

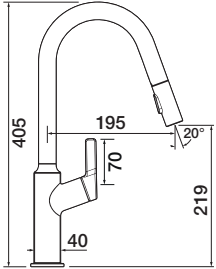

KARUMA PULL-OUT

The **Karuma's** sophisticated slimline design is complemented by the latest crank spout design. This ultra-modern mixer offers latest tech operation, including silky smooth pull-out spout with the added benefit of twin-flow options for multi-tasking.

Ref. KAR20CP Chrome **£249**

Ref. KAR20BN Brushed Nickel PVD **£259**

Ref. KAR20MB Matt Black **£269**

Ref. KAR20BB Brushed Brass PVD **£279**

WRAS Approved



- **TWO-FUNCTION SPRAY-HEAD**
Button allows you to switch from aerated flow to needle jet spray – ideal for rinsing down and generating detergent foam.
- **EXTENSION**
Pull-out handset extends to 60cm
- **PVD COATING**
Helps to withstand surface damage and provides a more hygienic surface
- **Energy saving cold-start control**



Brushed Nickel PVD



Chrome



Brushed Nickel PVD



Matt Black



Brushed Brass PVD

SANTOR

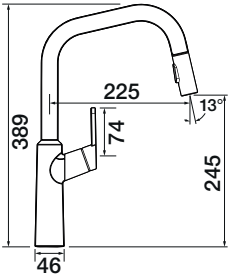

SANTOR PULL-OUT

The **Santor Pull-Out** is a great all-rounder, with smart aesthetics including a subtly tapered body and tilted ergonomic control lever. Practicality is of paramount importance and the easy pull-out hand-set offering twin flow options for multi-tasking.

Ref. SAN20CP Chrome £249

Ref. SAN20BN Brushed Nickel PVD £259

Ref. SAN20MB Matt Black £269

Ref. SAN20BB Brushed Brass PVD £279

WRAS Approved



Chrome

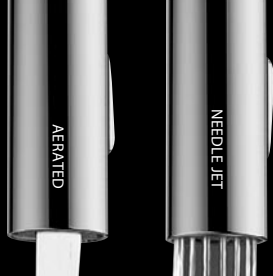

- **TWO-FUNCTION SPRAY-HEAD**
Button allows you to switch from aerated flow to needle jet spray – ideal for rinsing down and generating detergent foam.
- **EXTENSION**
Pull-out handset extends to 60cm
- **Energy saving cold-start control**



Matching Wastes available
see page 158



Chrome Brushed Nickel PVD Matt Black Brushed Brass PVD

PVD COATING
Helps to withstand surface damage and provides a more hygienic surface

clearwater



Pioneer
See the non pull-out version of the Pioneer tap on page 229.



PULL-OUT PIONEER

CHROME

BRUSHED NICKEL PVD

MATT BLACK

BRUSHED BRASS PVD

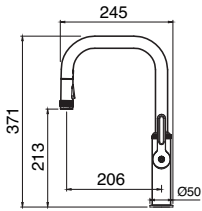
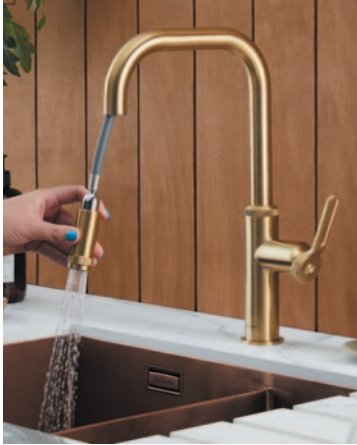

PIONEER PULL-OUT

The design of the **Pioneer Pull-Out** has been inspired by the aesthetics of our industrial past with its use of knurled components and steam valve style lever. The pull-out spout adds to this tap's versatility with its switch controlled flow options providing aerated water for filling and needle jet spray for rinsing.

Ref. PIL40CP Chrome £356

Ref. PIL40BN Brushed Nickel PVD £377

Ref. PIL40MB Matt Black £389

Ref. PIL40BB Brushed Brass PVD £399

WRAS Approved



Brushed Brass PVD

- **PVD COATING**
Helps to withstand surface damage and provides a more hygienic surface
- **Energy saving cold-start control**



Chrome



Brushed Nickel PVD



Matt Black



Brushed Brass PVD



TAP ICONS EXPLAINED



Pull-out Dual Flow Spray
Increases operating range of the tap and provides easy switching from aerated flow to needle spray.



Minimum Operating Water Pressure
See full water pressure guide on page 219.



Maximum Spout Swivel



Cold Start
Energy saving cartridge means when the lever is in the vertical position, it only dispenses cold water and not mixed. Forward rotation avoids the lever hitting the splashback.



The Cascade SLC aerator offers anti-limescale features, with a rubber face to prevent scale amalgamation, simple to clean with just a gentle rub.

CRETA PULL-OUT

The **Creta Pull-Out** is a great all rounder with a simple to use hand spray with twin spray modes - changeable at the press of a button.

Ref. **CREPOCP** Chrome £242

Ref. **CREPOBN** Brushed Nickel £293

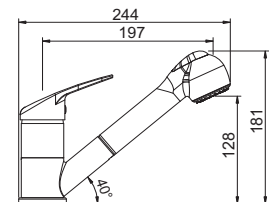

PORRIMA PULL-OUT

The **Porrima** possesses a gently fluted shape making it slightly less stern than the usual sheer minimalist styling.

Ref. **PO3CP** Chrome £327

Ref. **PO3BN** Brushed Nickel PVD £376

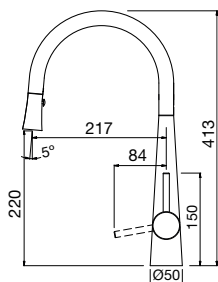

Matching Wastes available
see page 158



Water Pressure Explained - page 219

Modern Taps

PULL-OUT

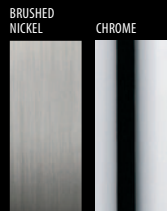

Chrome

EMPORIA

The **Emporia** has a pragmatic down to earth presence and is an old favourite that just keeps delivering.

Ref. EMPCP
Chrome **£328**

Ref. EMPBS
Brushed Nickel **£366**

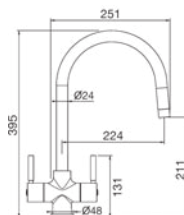

CLASSIC STYLES

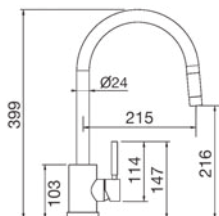

ELMIRA

A crisply sculptured mixer with the added benefit of a pull-out aerator.

Ref. ELMCP Chrome **£344**

Ref. ELMBS Brushed Nickel **£392**



Chrome

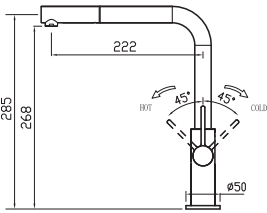

Ref. AUR2CP Chrome/White **£190**

Ref. AUR2BN
Brushed Nickel PVD/White **£216**

Ref. AUR3CP Chrome/Black **£190**

Ref. AUR3BN
Brushed Nickel PVD/Black **£216**



Chrome/White

AURIGA

A slimline family of taps available in all metal finishes or supplied with a choice of hardwearing coloured spouts – perfect for coordinating with door fronts and appliances.

COLOURS

- Black
- White

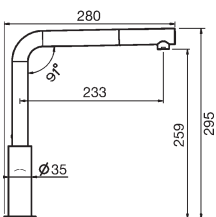

Ref. CW00214CP Chrome **£230**

Ref. CW00214BN Brushed Nickel **£259**



TAP ICONS EXPLAINED



Pull-out Aerated Spray
Increases operating range of the tap supplying a single aerated flow.



Pull-out Dual Flow Spray
Increases operating range of the tap and provides easy switching from aerated flow to needle spray.



Minimum Operating Water Pressure
See full water pressure guide on page 219.



Maximum Spout Swivel



PROFESSIONAL

This shining star of the kitchen is an impressive centre piece that can multi-task with expertise. The professional style spout swivels on its holder and can be detached and directed for close work, with most models having dual flow handsets that can deliver a standard aerated flow for filling and needle-jet spray for rinsing.



Brushed Brass

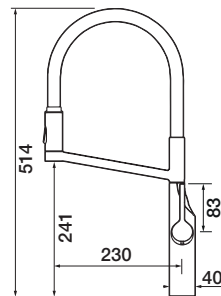

ALASIA PRO

The **Alasia Pro** is the latest generation of semi-professional taps. The tall architectural body has subtle design elements that blend perfectly together with an easy-maintenance silicon spout that can swivel and pull-down for food prep and the detachable hand-set offers twin flow options at the press of a button.

The handset can be positioned with the button at the front or back, whichever is more comfortable.

- Ref. ALA30CP** Chrome £269
- Ref. ALA30BN** Brushed Nickel PVD £279
- Ref. ALA30MB** Matt Black £289
- Ref. ALA30BB** Brushed Brass PVD £299

WRAS Approved





Chrome



Brushed Nickel PVD



Matt Black



Brushed Brass PVD



Chrome

TAP ICONS EXPLAINED



Pull-out Dual Flow Spray
Increases operating range of the tap and provides easy switching from aerated flow to needle spray.



1.0 BAR
Minimum Operating Water Pressure
See full water pressure guide on page 219.



360°
Maximum Spot Swivel



Cold Start
Energy saving cartridge means when the lever is in the vertical position, it only dispenses cold water and not mixed. Forward rotation avoids the lever hitting the splashback.



- **DETACHABLE TWO-FUNCTION SPRAY HEAD**
Aerator & Cascade
- **EASY-DOCK SPRAY HEAD**
- **EASY CLEAN SPRAY JETS**
- **COLD START**
- **PVD COATING**
Helps to with-stand surface damage and provides a more hygienic surface



Matching Wastes available
see page 158



Water Pressure Explained - page 219



PROFESSIONAL GALAXY

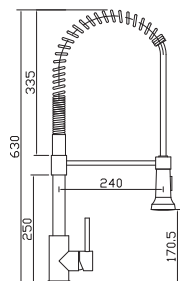
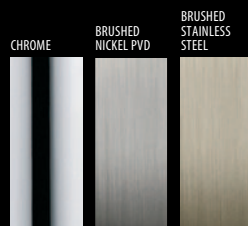

GALAXY

The **Galaxy** is constructed from solid 304 grade stainless steel and is a full scale professional tap providing great reach with its dual flow handset.

Ref. **GAX2SS**

Stainless Steel £384

- Energy saving cold-start control



Stainless Steel

TAP ICONS EXPLAINED



Professional Dual Flow Spray
360° flexible spout with easy switching from aerated flow to needle spray.



Pull-out Dual Flow Spray
Increases operating range of the tap and provides easy switching from aerated flow to needle spray.



Minimum Operating Water Pressure
See full water pressure guide on page 219.



Cold Start
Energy saving cartridge means when the lever is in the vertical position, it only dispenses cold water and not mixed. Forward rotation avoids the lever hitting the splashback.



Maximum Spout Swivel



Water Pressure Explained - page 219

TUTTI PRO

The **Tutti Pro** is a twin steel design with a flexible steel sprung coil to maximise the spout range, it also comes equipped with a chef's dual flow handset.

Ref. TP2CP Chrome **£306**

Ref. TP2BN
Brushed Nickel PVD **£327**

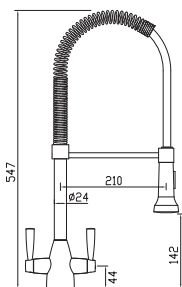

Chrome

Brushed Nickel PVD

TRITON

The **Triton** offers all the professional tap attributes - detachable dual flow handset and pull-out sprung steel coil for greater flexibility.

Ref. TR2CP
Chrome **£265**

Ref. TR2BN
Brushed Nickel PVD **£305**

- Energy saving cold-start control

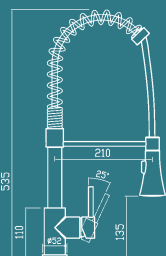

Brushed Nickel PVD

Chrome

PROFESSIONAL MERIDIAN



The **Meridian** is a semi-professional mixer with easy-clean silicon spouts that feature twin flow aerators. The spouts are ideal for colour coordinating with hob and appliances and can be detached from their swivel-holder when a longer reach is required.

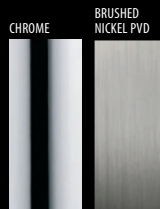

HOSE COLOURS

- Black MEBT £23
- White MEWT £23
- Grey MEGT £23
- Red MERT £23

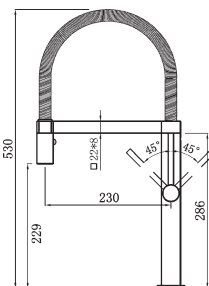

Meridian single lever monobloc with detachable white silicon swivel spout with dual-flow spray.

Ref. ME2CP
Chrome/White £303

Ref. ME2BN
Brushed Nickel PVD/White £347



White &
Brushed Nickel PVD



Meridian single lever monobloc with detachable black silicon swivel spout with dual-flow spray.

Ref. ME3CP
Chrome/Black £303

Ref. ME3BN
Brushed Nickel PVD/Black £347



Black &
Chrome

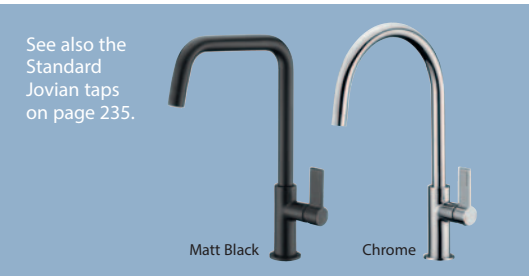

JOVIAN

The **Jovian** boasts modern slimline construction with a close sprung coil and detachable dual flow handset with integrated flow switch.

Jovian single lever monobloc with spring swivel spout detachable dual flow handset with integrated flow switch.

Ref. JO2CP Chrome £303



TAP ICONS EXPLAINED



Professional Single Flow
360° flexible spout with single aerated flow.



Professional Dual Flow Spray
360° flexible spout with easy switching from aerated flow to needle spray.



Minimum Operating Water Pressure
See full water pressure guide on page 219.

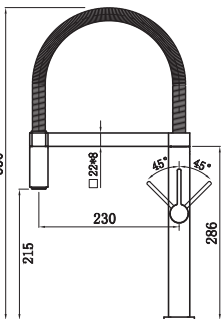



STAINLESS STEEL

Stainless steel taps are becoming more and more popular with very good reason. They are the perfect match with stainless steel sinks and appliances and they are highly resilient to wear and tear whilst retaining their lustrous good-looks for years.

BRUSHED
STAINLESS STEEL



SINGLE LEVER



TITANIA

The tall slender shape of the **Titania** mixers make a dynamic statement with their elegant tapering design and truly represent the next generation of minimalist styling.

- Energy saving cold-start control

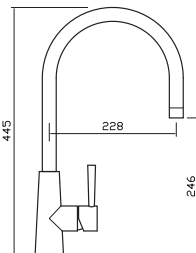

Titania
Ref. T12SS Stainless Steel £222



Titania Pull-out
Ref. T13SS Stainless Steel £402

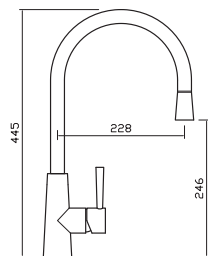

TAP ICONS EXPLAINED



Pull-out Aerated Spray
Increases operating range of the tap supplying a single aerated flow.



Minimum Operating Water Pressure
See full water pressure guide on page 219.



Maximum Spout Swivel



Cold Start
Energy saving cartridge means when the lever is in the vertical position, it only dispenses cold water and not mixed. Forward rotation avoids the lever hitting the splashback.



Water Pressure Explained - page 219

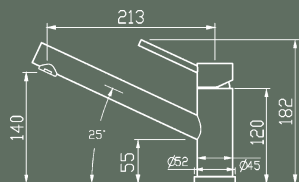

Sirius
Ref. S12SS Stainless Steel £217



SIRIUS

The classic simple tube design of the **Sirius** offers cool minimalism in the kitchen and looks great when paired with granite and under-mount bowls. These iconic designs are available in standard or pull-out spouts.



Sirius Pull-out
Ref. S13SS Stainless Steel £278
REG4 Approved

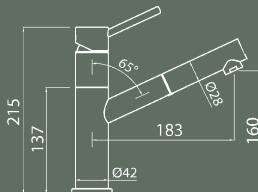



STAINLESS STEEL SINGLE LEVER

The universal Single Lever remains a popular choice for adding a continental style to the kitchen.

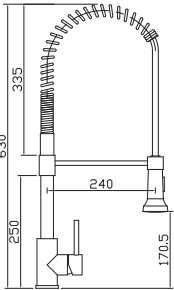

GALAXY

The **Galaxy** is constructed from solid 304 grade stainless steel and is a full scale professional tap providing great reach with its dual flow handset.

Ref. GAX2SS
Stainless Steel **£384**

- Energy saving cold-start control

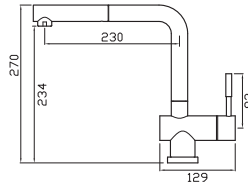
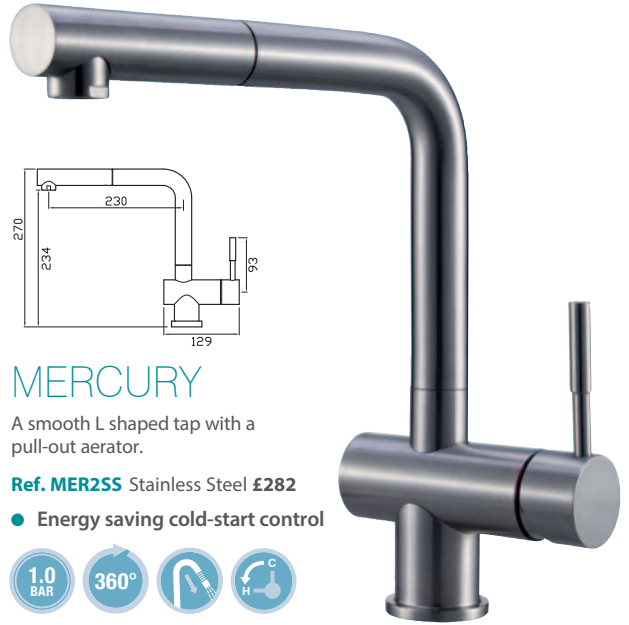

MERCURY

A smooth L shaped tap with a pull-out aerator.

Ref. MER2SS Stainless Steel **£282**

- Energy saving cold-start control



COLD WATER SIPHON

This compact cold water tap is a perfect solution to install with a secondary sink to create an entertainment area.

Please note there is also a filtered water version of this tap available in our Filter section.

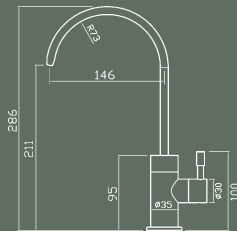

MIRA

Ref. MI2SSC Stainless Steel **£138**





STAINLESS STEEL TWIN LEVER

The Twin Lever taps work well with both low and high pressure systems and the separate controls are the most simple to operate.

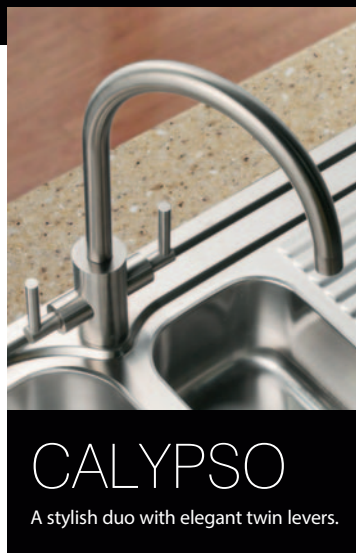

TAP ICONS EXPLAINED



Professional Dual Flow Spray
360° flexible spout with easy switching from aerated flow to needle spray.



Pull-out Aerated Spray
Increases operating range of the tap supplying a single aerated flow.



Minimum Operating Water Pressure
See full water pressure guide on page 219.



Maximum Spout Swivel



Cold Start
Energy saving cartridge means when the lever is in the vertical position, it only dispenses cold water and not mixed. Forward rotation avoids the lever hitting the splashback.



Water Pressure Explained - page 219

Modern Taps

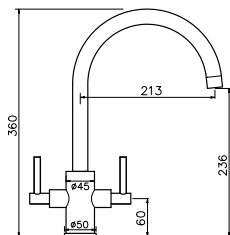

Ref. CAL2SS Stainless Steel £278
REG4 Approved

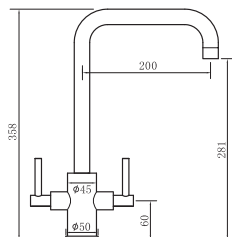

Ref. CAL3SS Stainless Steel £278
REG4 Approved

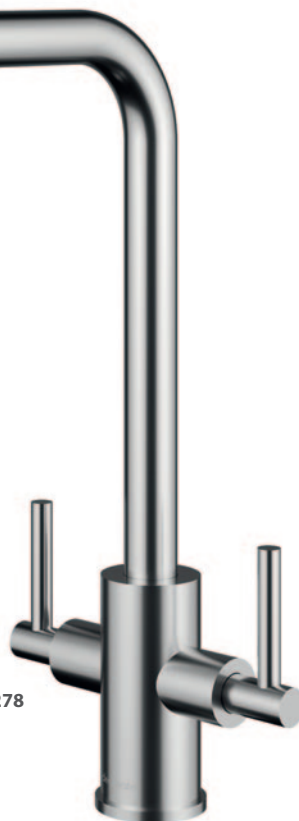

PULL-OUT SPRAY MODERN



Spray Controls



Needle Jet Spray



Aerated Spray



Chrome



Brushed Nickel PVD



Brushed Brass PVD



Matt Black



Stainless Steel

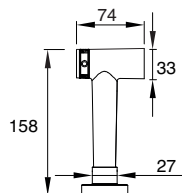

Modern Pull-Out Spray

- Ref. MP10CP Chrome £105
- Ref. MP10BN Brushed Nickel £120
- Ref. MP10BB Brushed Brass £130
- Ref. MP10MB Matt Black £125
- Ref. MP10SS Stainless Steel £125

Min Pressure 0.7 Bar
Mounting Hole Size Ø35mm

PULL-OUT SPRAY TRADITIONAL



Needle Jet Spray



Aerated Spray

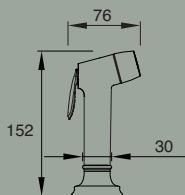

Traditional Pull-Out Spray

- Ref. TP10CP Chrome **£115**
 Ref. TP10BN Brushed Nickel **£130**
 Ref. TP10BB Brushed Brass **£140**
 Ref. TP10BC Brushed Copper **£135**
 Ref. TP10BZ Brushed Bronze **£145**

Min Pressure 0.7 Bar
 Mounting Hole Size Ø35mm



Chrome



Brushed
Nickel PVD



Brushed
Brass PVD



Brushed
Copper PVD



Brushed
Bronze PVD

The **Pull-Out Spray** is an incredibly useful tool for all manner of jobs, from rinsing off crockery prior to the dishwasher, rinsing veg and salads and cleaning down the sink.

Once you have one you will never be without one again!

They make a particularly valuable kitchen aid when partnered with non-pull out and professional taps when there is no facility for a directable flow.

There are two flow types at cold mains pressure:

Aerated - ideal for vessel filling and gentle rinsing of delicate food.

Needle-Jet - for rinsing the crockery prior to dishwasher, food preparation - washing salads and rice etc and rinsing around the sink bowl and drainer after use.

- 60cm working range with auto-retract hose
- Twin flow types: Aerated, Needle-Jet
- Auto lock for hands-free operation
- Mains pressure cold flow – variably controlled
- Five finishes perfectly matched with the Clearwater modern and traditional ranges

VENUE CONTRACT TAPS

12 YEAR WARRANTY

A range of highly durable WRAS approved taps suitable for mono hole and two tap hole sinks.
Please see pages 122 -123 for perfect partner.



Venue Modern Sink Pillars
Ref. DCM103
Chrome **£54** (pair)

LP Min 0.1 bar pressure required
Mounting hole size \varnothing 28mm
WRAS Approved

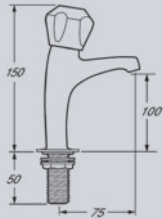

Venue Modern Mono Sink Mixer
Ref. DCM104
Chrome **£107**

LP Min 0.1 bar pressure required
Swivel Spout / Dual Flow
Mounting hole size \varnothing 35mm
WRAS Approved

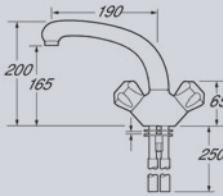

Venue Modern Deck Mounted Sink Mixer
Ref. DCM105
Chrome **£91**

LP Min 0.1 bar pressure required
Swivel Spout / Dual Flow
Mounting hole size \varnothing 2 x 28mm
WRAS Approved

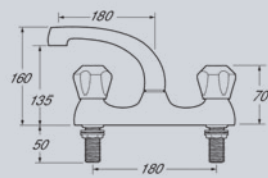

Venue Lever Sink Pillars
Ref. DLT103
Chrome **£59** (pair)

LP Min 0.1 bar pressure required
Mounting hole size \varnothing 28mm
WRAS Approved

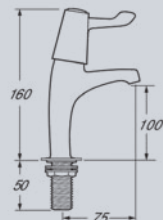

Venue Lever Mono Sink Mixer
Ref. DLT104
Chrome **£107**

LP Min 0.1 bar pressure required
Swivel Spout / Dual Flow
Mounting hole size \varnothing 35mm
WRAS Approved

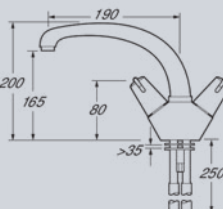

Venue Lever Deck Mounted Sink Mixer
Ref. DLT105
Chrome **£101**

LP Min 0.1 bar pressure required
Swivel Spout / Dual Flow
Mounting hole size \varnothing 2 x 28mm
WRAS Approved

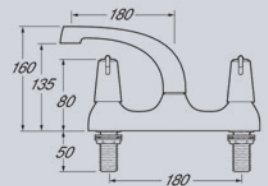

MERCIA

A range of highly durable WRAS approved taps suitable for mono hole and two tap hole sinks.

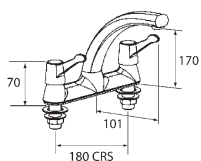

Mercia QT lever deck sink mixer
Ref. 351908 Chrome £123

Quarter turn CD valves
 LP Min 0.1 bar pressure required
 360° swivel spout
 Mounting hole sizes \varnothing 2 x 28mm - 180mm centres
 WRAS Approved

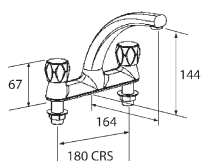

Mercia Modern deck sink mixer with twin controls
Ref. 4M3915 Chrome £114

Compression full turn valves
 LP Min 0.1 bar pressure required
 360° swivel spout
 Mounting hole sizes \varnothing 2 x 28mm - 180mm centres
 WRAS Approved

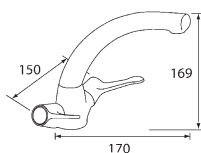

Mercia QT Lever Sink Mixer
Ref. 351910 Chrome £111

Quarter turn CD valves
 LP Min 0.1 bar pressure required
 360° swivel spout
 Mounting hole size \varnothing 35mm
 WRAS Approved

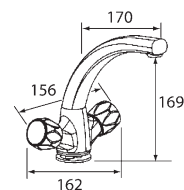

Mercia Modern Sink Mixer
Ref. 4M3917 Chrome £105

Compression full turn valves
 LP Min 0.1 bar pressure required
 360° swivel spout
 Mounting hole size \varnothing 35mm
 WRAS Approved

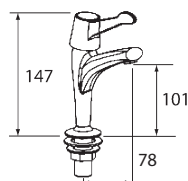

Mercia QT Lever Sink Pillars
Ref. 351907 Chrome £84 (pair)

Quarter turn CD valves
 LP Min 0.1 bar pressure required
 Mounting hole size \varnothing 28mm
 WRAS Approved

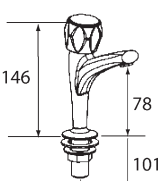

Mercia Modern Sink Pillars
Ref. 4M3913 Chrome £78 (pair)

Compression full turn valves
 LP Min 0.1 bar pressure required
 Mounting hole size \varnothing 28mm
 WRAS Approved



Water Pressure Explained - page 219

KWC

Swiss Water Experience

KWC started producing kitchen and bathroom taps in 1897 and soon became highly successful with their determined pursuit of excellence. They were soon a well known brand all around Europe and their taps were fitted in the Hotel Ritz in Paris in 1911.

www.kwc.com



KWC EVE

The **KWC Eve** collection are a shining example of creativity and innovation. The unique combination of the highest quality metals combined with the play of light and water result in a most seductive form.

This beautiful tap is available with or without lighting and is made in four finishes:

Solid stainless steel, chrome or a new black chrome and a particularly velvety white which perfectly matches Corian surfaces.

These new finishes now provide greater scope for creative freedom.



Eve Soap Dispenser

Ref. Z 536.063.000

Chrome £310

Ref. Z 536.063.700

Stainless Steel £413



KWC KIO

The **Kio** is the latest generation of taps from KWC. There are two manual swivel control models, one with a standard swivel spout, the other with a pull-out spray, while the star of the range is an electronic control model with the latest touch control technology. These taps are available in three finishes, chrome, stainless steel and matt black, that offer a distinct choice that can be coordinated with most room styles. The KWC material and build quality becomes even more evident when you start using one of these super taps.



Chrome



Decor Steel



Matt Black

KIO single lever monobloc with swivel spout

Ref. 10.481.012.000

Chrome **£388**

Ref. 10.481.012.127

Decor Steel **£534**

Ref. 10.481.012.176

Matt Black **£534**

HP Min. 1.0 bar pressure required

360° swivel spout

Mounting hole size \varnothing 35mm

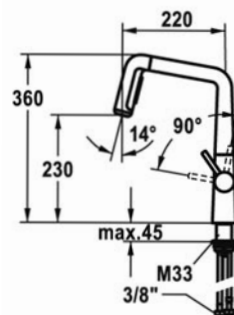
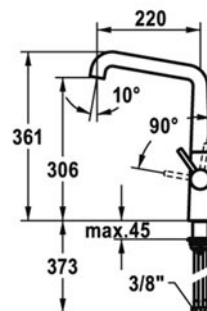

KIO single lever monobloc with pull-out spray

Ref. 10.481.002.000

Chrome **£553**

Ref. 10.481.002.127

Decor Steel **£748**

Ref. 10.481.002.176

Matt Black **£748**

HP Min. 1.0 bar pressure required

360° swivel spout

Pull-out length 40cm

Mounting hole size \varnothing 35mm

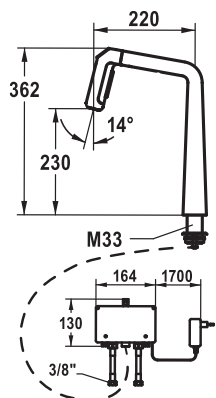

KIO-E with electronic control and pull-out spray

Ref. 10.481.232.000 Chrome **£942**

Ref. 10.481.232.127 Decor Steel **£1263**

Ref. 10.481.232.176 Matt Black **£1263**

HP Min. 1.0 bar pressure required

360° swivel spout

Pull-out length 40cm

Mounting hole size Ø 35mm



KWC KIO-E



The **KIO-E** uses the latest electronic LED technology which means both water flow and temperature can be controlled with a touch of a button. The LED light glows red and blue to denote the water temperature. This smart tap is also programmable to perform functions such as hygiene flushing, temperature calibration and automatic switch-off. The ergonomically designed pull-out spray-head has an anti-slip silicon grip for ease of use and with an integrated button to switch between two flow options.

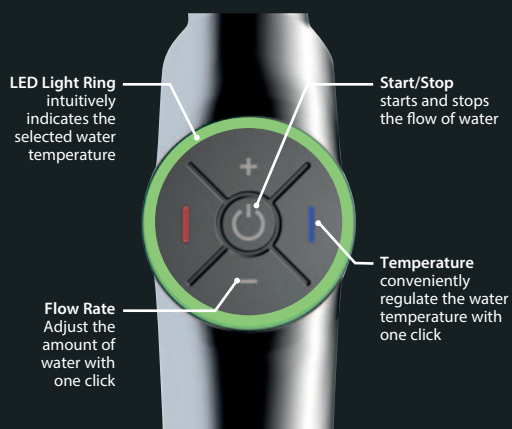

Laminar clear flow



Needle spray flow



KWC LUNA-E

The **Luna-E** family of taps come in two forms; with either side lever control or top lever control. Both these variants offer standard swivel spout and pull-out spray spout options.

These taps are available in two finishes, chrome and matt black, that offer a distinct choice that can be coordinated with most room styles. The KWC material and build quality becomes even more evident when you start using one of these super taps.

Luna-E single lever monobloc with 'U' swivel spout
Ref. 10.441.013.000 Chrome **£242**
Ref. 10.441.013.176 Matt Black **£310**

HP Min. 1.0 bar pressure required
 360° swivel spout
 Mounting hole size Ø 35mm

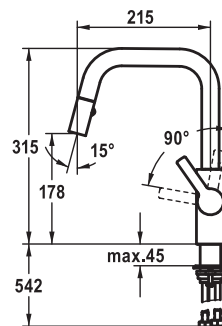
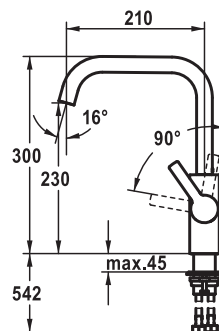

Luna-E single lever monobloc with 'U' spout and pull-out spray with SPRAYCLEAN
Ref. 10.441.004.000 Chrome **£337**
Ref. 10.441.004.176 Matt Black **£429**

HP Min. 1.0 bar pressure required
 360° swivel spout
 Pull-out length 40cm
 Mounting hole size Ø 35mm

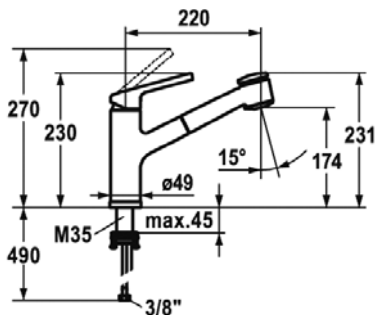

Luna-E single lever monobloc with pull-out spray with SPRAYCLEAN

Ref. 10.441.033.000 Chrome **£304**

Ref. 10.441.033.176 Matt Black **£394**

HP Min. 1.0 bar pressure required

360° swivel spout

Pull-out length 60cm

Mounting hole size Ø 35mm

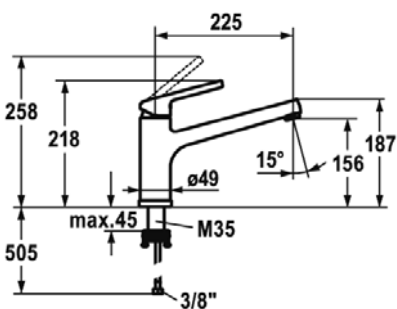

Luna-E single lever monobloc with swivel spout

Ref. 10.441.023.000 Chrome **£220**

Ref. 10.441.023.176 Matt Black **£286**

HP Min. 1.0 bar pressure required

160° swivel spout

Mounting hole size Ø 35mm



SprayClean

Actively helps with the removal of limescale: With a special faceplate and fastening mechanism, SprayClean prevents limescale buildup.

Any deposits are sprayed away automatically when the water is running.

The special fastening mechanism helps with more stubborn lime deposits: simply turn, clean, and the job is done.



PowerClean

The spray you want at the touch of a button:

PowerClean makes it exceedingly easy to switch the flow of water on the spray head – from a standard spray to a fine needle spray.

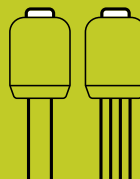

Water Pressure Explained - page 219

KWC DOMO 6

The **Domo** family combine top lever and side lever models and a choice of pull-out spray models offering the latest 'Tripleclean' flow technology.

This new generation of taps are refined with assured KWC Swiss quality that are a pleasure to use with their ergonomic design.

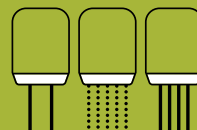

TripleClean

Three water streams for more flexibility: TripleClean allows you to change between a normal stream for filling glasses, a soft spray for gently cleaning food, and a power spray for pre-rinsing and removing dirt from dishes.

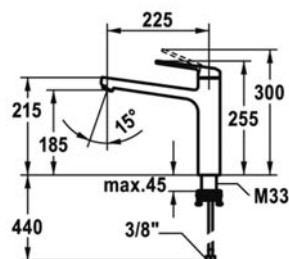

Domo single lever monobloc with swivel spout

Ref. 10.661.023.000

Chrome £317

Ref. 10.701.023.700

Stainless Steel £435

HP Min. 1.0 bar pressure required

150° swivel spout

Mounting hole size Ø 35mm

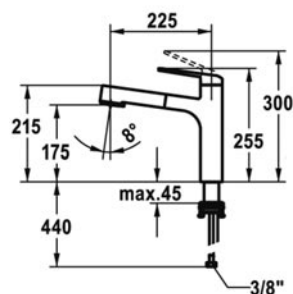

Domo single lever monobloc with pull-out spray with SPRAYCLEAN

Ref. 10.661.033.000

Chrome £437

Ref. 10.701.033.700

Stainless Steel £602

HP Min. 1.0 bar pressure required

TripleClean: Normal, Soft and Power Stream modes

120° swivel spout

Pull-out length 60cm

Mounting hole size Ø 35mm

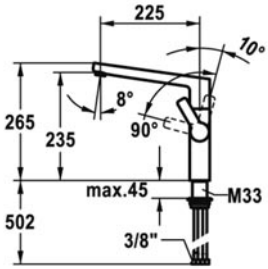

Domo single lever monobloc with swivel spout

Ref. 10.661.013.000

Chrome £350

Ref. 10.701.013.700

Stainless Steel £481

HP Min. 1.0 bar pressure required
360° swivel spout
Mounting hole size Ø 35mm

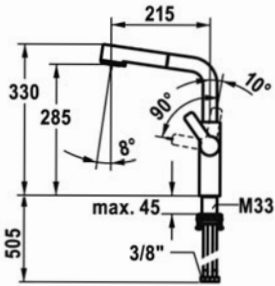

Domo single lever monobloc with pull-out spray with SPRAYCLEAN

Ref. 10.661.003.000

Chrome £481

Ref. 10.701.003.700

Stainless Steel £662

HP Min. 1.0 bar pressure required
TripleClean: Normal, Soft and Power Stream modes
150° swivel spout
Pull-out length 60cm
Mounting hole size Ø 35mm



SprayClean

Actively helps with the removal of limescale: With a special faceplate and fastening mechanism, SprayClean prevents limescale buildup.

Any deposits are sprayed away automatically when the water is running. The special fastening mechanism helps with more stubborn lime deposits: simply turn, clean, and the job is done.

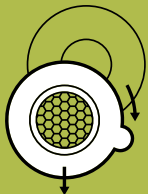

KWC ONO highflex extended water system

The **Highflex** are the latest generation of semi-professional taps. They are smaller in scale than their predecessors and have been totally modernised to suit contemporary domestic kitchens resulting in probably the most stylish multi-purpose tap available anywhere.



Ono High Flex shown with hand spray holder, which is supplied with every model.

A spring hose that defies gravity and will remain in its set position for the task in hand.

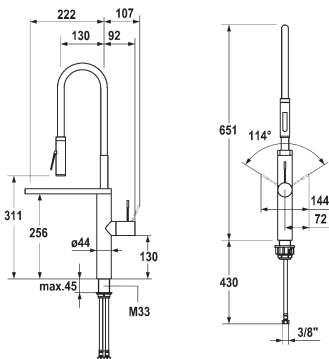

ONO Highflex with swivel spout and flexible spray

Ref. **10.151.423.000**
Chrome **£1580**

Ref. **10.151.423.700**
Stainless Steel **£2249**

HP Min. 2.0 bar pressure required

Flow rate at 3 bar:
Neoperl® Cascade
9ltrs per min
360° swivel spout
Mounting hole size Ø 35mm



reddot design award
winner 2008



KWCLIVELLO

The **Livello's** restrained elegant design will ensure this latest range from KWC as timeless classics. As with all KWC taps the Livello benefits from the highest quality materials and typical precision Swiss workmanship thus ensuring a long and trouble-free life.

Choose between the standard swivel spout or the ever popular pull-out aerator model.

- Please note the handle spec change with stainless steel models.



Practical, ergonomic, beautiful: the lever controls the water flow and allows you to switch from cold to hot in one fluid motion.



The integrated Neoperl Cache is easy to remove using the key supplied - and can be cleaned in no time at all.



The pull-out spout adds 60 cm to the tap's reach and can swivel a full 360° - making it an ideal choice for an island installation.

Livello single lever monobloc with swivel spout

Ref. 10.231.013.000
Chrome **£353**

Ref. 10.231.013.700
Stainless Steel **£530**

HP Min. 1.0 bar pressure required
Flow rate at 3 bar 11ltrs per min
160° swivel spout

Mounting hole size Ø 35mm
Fastening: Threaded sleeve D33 L45mm

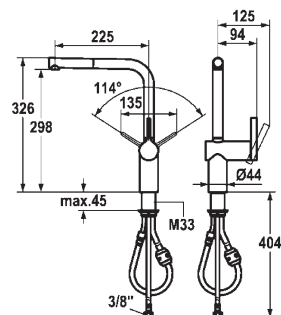
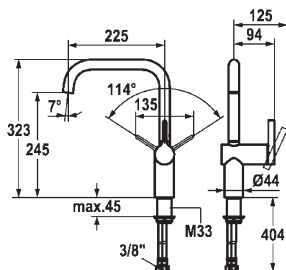

Livello single lever monobloc with pull-out spout

Ref. 10.231.103.000
Chrome **£460**

Ref. 10.231.103.700
Stainless Steel **£689**

HP Min. 2.0 bar pressure required
Flow rate at 3 bar 10ltrs per min

Pull-out hose length 60cm
360° swivel spout

Mounting hole size Ø 35mm

Fastening:
Threaded sleeve D33 L45mm



Handle shape for Chrome model



Handle shape for Stainless Steel model



Water Pressure Explained - page 219



Ref. 10.261.432.000FL

Sin single lever monobloc with highflex® swivel spout

Chrome **£698**

- HP** Min. 2.0 bar pressure required
- Flow rate at 3 bar:
- Neoperl® Cache 8ltrs per min
- NeedleSpray 6ltrs per min
- 360° swivel spout
- Mounting hole size Ø 35mm
- Lever installation on left or right side

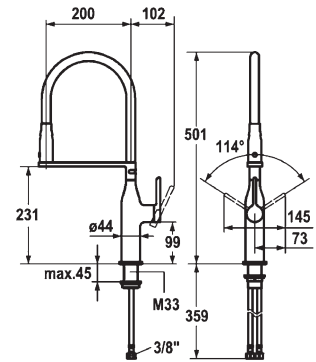

Ref. 10.261.002.000FL

Sin single lever monobloc with swivel/pull-out spout

Chrome **£587**

- HP** Min. 2.0 bar pressure required
- Flow rate at 3 bar:
- Neoperl® Cache 7ltrs per min
- NeedleSpray 6ltrs per min
- Hose pull-out length 50cm
- 360° swivel spout
- Mounting hole size Ø 35mm
- Lever installation on left or right side

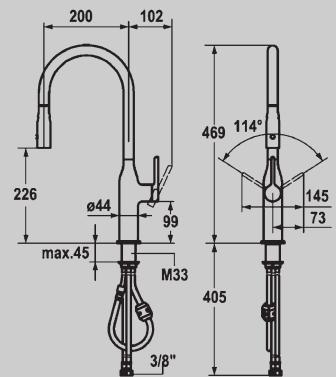

Neoperl Cache Stream



Needle Spray Stream

Both Sin models feature dual flow options - Press the button to change the flow type from cache stream to spray mode. Automatically diverts to Cache stream when the tap is turned on.



Ref. Z 536.062.700
Inox Soap Dispenser
Stainless Steel **£370**



The pull-out handset in Cascade mode



The pull-out handset in Shower Spray mode



Ref. 10.271.033.700

Inox monobloc with pull-out spray
Stainless Steel **£888**

HP Min. 1.5 bar pressure required
Flow rate at 3 bar:
Neoperl® Cascade 12ltrs per min
Shower Spray 13ltrs per min
Pull-out hose length 70cm
160° swivel spout
Mounting hole size Ø 35mm

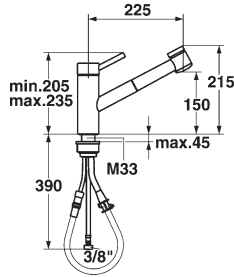

KWC INOX

The KWC **Inox** exudes its high quality at every glance and touch. The elegant design combined with the cool solid stainless steel make for a very desirable tap.

The convenient pull-out spray is a pleasure to operate, simply press the button on top of the handset and the water flow changes from cascade to fine needle jets to suit the job in hand.

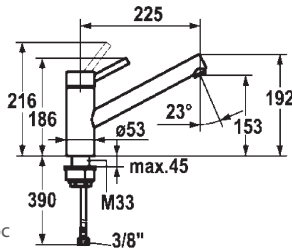

Ref. 10.271.023.700

Inox single lever monobloc with swivel spout
Stainless Steel **£679**

HP Min. 1.5 bar pressure required
Flow rate at 3 bar:
Neoperl® Cascade 12ltrs per min
160° swivel spout
Mounting hole size Ø 35mm



KWC ZOE

TOUCH LIGHT PRO

KWC **ZOE touch light PRO** is a faucet controlled using smart technology. It responds intuitively to a brief touch and is extremely easy to programme to suit your personal habits and needs. The round operating unit also features a light ring, which indicates the water temperature selected – so you can be sure that you have everything under control!

Everything is designed to provide maximum convenience and meet individual user requirements, while saving energy and water in the process.

Zoe electronic monobloc with pull-out spout with Touch Light Pro technology

Ref. 10.201.242.000 Chrome **£2186**

Ref. 10.201.242.176 Matt Black **£2405**

HP Min. 2.0 bar pressure required

Flow rate at 3 bar:

Neoperl® 8ltrs per min

NeedleSpray 9ltrs per min

270° swivel spout

Pull-out hose length 50cm

Mounting hole size Ø 35mm

Fastening - threaded sleeve D33 L45mm

Mains receiver 100-240V/operating voltage 6.75 V/1100mm

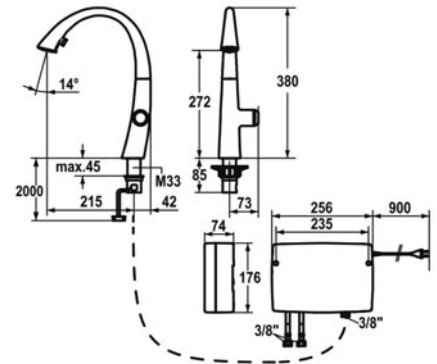

1x touch Cold water = Blue



2x touch Warm water = Orange



3x touch Hot water = Red



KWC ZOE

Fluid lines and perfectly balanced proportions make the **Zoe** a style icon that will be the star billing in any kitchen. Both taps have a concealed pull-down aerator for rinsing and extending the tap's range which you will find incredibly useful. Why not add to the Zoe's extravagance and select the model with built in LED's that provide a fascinating interplay between water and light.



Zoe single lever monobloc with pull-out spout without LEDShine

Ref. 10.201.102.000 Chrome **£751**
Ref. 10.201.102.176 Matt Black **£939**

HP Min. 2.0 bar pressure required
Flow rate at 3 bar:
Neoperl® 8ltrs per min
NeedleSpray 9ltrs per min
270° swivel spout
Pull-out hose length 50cm
Mounting hole size Ø 35mm
Fastening - threaded sleeve D33 L45mm

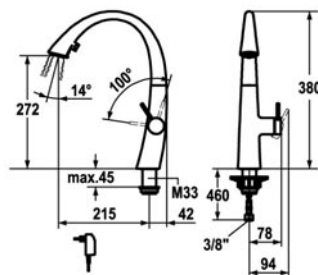

Zoe Soap Dispenser
Z.536.586.000 Chrome **£363**
Z.536.586.176 Matt Black **£467**



Zoe single lever monobloc with pull-out spout with LEDShine

Ref. 10.201.122.000 Chrome **£980**
Ref. 10.201.122.176 Matt Black **£1169**

HP Min. 2.0 bar pressure required
Flow rate at 3 bar:
Neoperl® 8ltrs per min
NeedleSpray 9ltrs per min
270° swivel spout
Pull-out hose length 50cm
Mounting hole size Ø 35mm
Fastening - threaded sleeve D33 L45mm
Mains receiver 100-240V/operating voltage 6.75 V/1100mm



LED light: the LUMINAQUA LED function light can be operated using an ON/OFF membrane button integrated in the pull-out spray. It switches off automatically after 30 minutes.

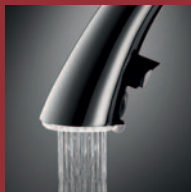

Two types of jet: it is easy to switch between Neoperl jet and needle spray at the touch of a button.



Pull-out spray: the spray, which is integrated flush in the spout, can be pulled out by up to 50 cm.



Turn & Clean and JETCLEAN: easy cleaning of the spray (Turn & Clean) and effective protection against limescale (JETCLEAN) all in one.



Sophisticated lever design: the delicate yet robust lever blends discreetly into the background thanks to its dark colour.



PERRIN & ROWE

MAYFAIR LONDON

www.perrinandrowe.co.uk

Established in 1978, Perrin & Rowe has become the largest independent manufacturer of taps in the UK. With factories in Tamworth, Rainham and Wolverhampton, all Perrin & Rowe products are manufactured here in the UK by a skilled team of engineers.

Renowned for its commitment to quality, design and innovation, Perrin & Rowe is a true British success story. Having built an enviable reputation and a premium portfolio of hand-crafted products, Perrin & Rowe is globally recognised as a market leader and highly respected British manufacturer.



The Rinse

Hot, cold or mixed water is diverted to the rinse once the top button is pressed. Perrin & Rowe hand rinses have been designed to cope with even low water pressures; the integration of a patented diverter means that they can be effective with just 1 bar of pressure.

Special Finishes

A range of luxurious, warm metallic hues custom made to order.

Allow up to 10 to 12 weeks for delivery. (**Use suffix when ordering)

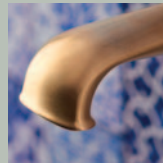

Satin Brass (SB)

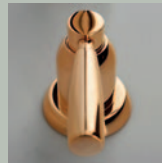

Gold (IG)

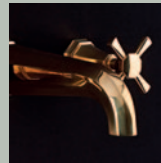

Polished Brass (BR)

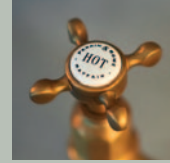

Aged Brass (AB)

CALLISTO

The **Callisto** straddles both contemporary and classic design and is available with either crosshead or lever handles. This three or four hole tap is designed to be work top mounted usually behind undermount sinks. This combination results in a most sophisticated arrangement.



Callisto three-hole mixer 'C' spout with crossheads

Ref. 4885 CP Chrome **£640**

Ref. 4885 NI Nickel **£704**

Ref. 4885 PF Pewter **£768**

Callisto three-hole mixer 'C' spout with crossheads and rinse

Ref. 4890 CP Chrome **£843**

Ref. 4890 NI Nickel **£928**

Ref. 4890 PF Pewter **£1012**

Recommended working pressure

HP Min 1.0 bar Max 5.0 bar

Quarter turn ceramic disc flow control

Single flow spout

360° swivel spout

Spout mounting hole size Ø 35mm

Controls mounting hole size Ø 30mm

Rinse pull-out hose length 60cm

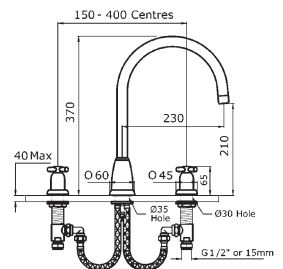

Rubiq monobloc mixer 'U' spout with lever handles

Ref. 4210 CP Chrome **£460**

Ref. 4210 NI Nickel **£507**

Ref. 4210 PF Pewter **£553**

Rubiq monobloc mixer 'U' spout with lever handles and rinse

Ref. 4310 CP Chrome **£664**

Ref. 4310 NI Nickel **£730**

Ref. 4310 PF Pewter **£797**

HP Min 1.0 bar Max 5.0 bar pressure
360° swivel spout
Mounting hole size Ø 35mm
Rinse pull-out hose length 60cm
Rinse mounting hole size Ø 30mm

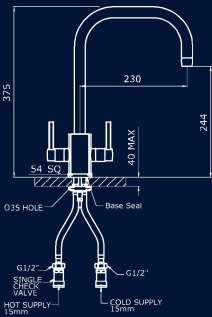

RUBIQ

Restrained styling makes this contemporary tap especially smart - softly sculptured rectangles and minimalist cylinders combine to create a very sophisticated design and surely a future classic.



Callisto three-hole mixer 'C' spout with levers

Ref. 4886 CP Chrome **£640**

Ref. 4886 NI Nickel **£704**

Ref. 4886 PF Pewter **£768**

Callisto three-hole mixer 'C' spout with levers and rinse

Ref. 4891 CP Chrome **£843**

Ref. 4891 NI Nickel **£928**

Ref. 4891 PF Pewter **£1012**

Recommended working pressure

HP Min 1.0 bar Max 5.0 bar
Quarter turn ceramic disc flow control
Single flow spout
360° swivel spout
Spout mounting hole size Ø 35mm
Controls mounting hole size Ø 30mm
Rinse pull-out hose length 60cm

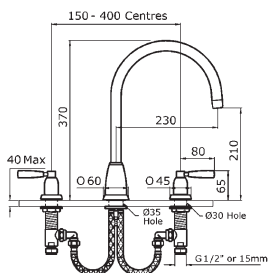



OBERON

The femininely shaped **Oberon** is a delightful combination of soft curves and is an evolution of the more minimalist forbears. There are two models to choose from; one with the ever useful pull-out Rinse.

Oberon twin lever monobloc mixer with 'C' spout

Ref. 4861 CP Chrome **£447**

Ref. 4861 NI Nickel **£492**

Ref. 4861 PF Pewter **£537**

Oberon twin lever monobloc mixer with 'C' spout and rinse

Ref. 4866 CP Chrome **£650**

Ref. 4866 NI Nickel **£716**

Ref. 4866 PF Pewter **£781**

HP Min 1.0 bar Max 5.0 bar pressure

360° swivel spout

Mounting hole size Ø 35mm

Rinse mounting hole size Ø 30mm

Rinse pull-out hose length 60cm

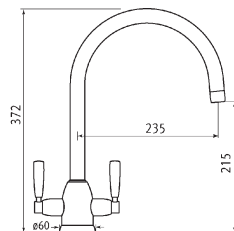

The Rinse

Hot, cold or mixed water is diverted from the running tap to the rinse once the handset trigger is pressed.

Perrin & Rowe's patented Rinses can cope with low pressure - minimum 1 bar. All handsets are also insulated against hot water.

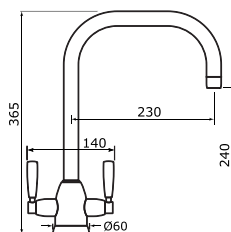

Oberon twin lever monobloc mixer with 'U' spout

Ref. 4863 CP Chrome **£447**

Ref. 4863 NI Nickel **£492**

Ref. 4863 PF Pewter **£537**

Oberon twin lever monobloc mixer with 'U' spout and rinse

Ref. 4868 CP Chrome **£650**

Ref. 4868 NI Nickel **£716**

Ref. 4868 PF Pewter **£781**

Recommended working pressure

HP Min 1.0 bar Max 5.0 bar

Quarter turn ceramic disc flow control

Single flow spout

360° swivel spout

Mounting hole size Ø 35mm

Rinse mounting hole size Ø 30mm

Rinse pull-out hose length 60cm

ORBIQ

The **Orbiq's** uncompromising minimalist design has been copiously copied since its conception but none of its imitators can surpass the Orbiq's workmanship.

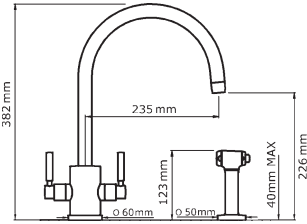

Orbiq twin lever monobloc mixer with 'C' spout

- Ref. 4212 CP** Chrome **£447**
- Ref. 4212 NI** Nickel **£492**
- Ref. 4212 PF** Pewter **£537**

Orbiq twin lever monobloc mixer with 'C' spout and rinse

- Ref. 4312 CP** Chrome **£650**
- Ref. 4312 NI** Nickel **£716**
- Ref. 4312 PF** Pewter **£781**

- HP** Min 1.0 bar Max 5.0 bar pressure
- 360° swivel spout
- Mounting hole size \varnothing 35mm
- Rinse mounting hole size \varnothing 30mm
- Rinse pull-out hose length 60cm



MIMAS

The elegantly sculptured Mimas not only has a beautiful shape it also boasts the latest ceramic disc technology that assures it to be a top performer.

Mimas single lever monobloc mixer with swivel 'C' spout

- Ref. 4841 CP** Chrome **£463**
- Ref. 4841 NI** Nickel **£510**
- Ref. 4841 PF** Pewter **£556**

Mimas single lever monobloc mixer with swivel 'C' spout and rinse

- Ref. 4846 CP** Chrome **£666**
- Ref. 4846 NI** Nickel **£733**
- Ref. 4846 PF** Pewter **£800**

- HP** Min 1.0 bar - Max 5.0 bar pressure
- 360° swivel spout
- Mounting hole size \varnothing 35mm
- Rinse pull-out hose length 60cm
- Rinse mounting hole size \varnothing 30mm

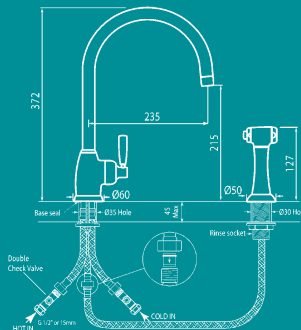



abode www.abode.eu

Abode are based in Yorkshire where they design taps for production in high quality factories in Europe and Asia.

Their principle aim has been to perfect a tap for the British market - this means many of their models work easily with our typically low pressure gravity systems.

You will also find their classical designs in our Traditional tap section.

FLAIR

New from the **Linear** range the Style's latest flat spout design combined with a purposeful tilt make this a great value designer tap.

Linear Flair twin lever monobloc with swivel spout

Ref. AT1220 Chrome **£229**

Ref. AT1221 Brushed Nickel **£240**

LP Min 0.5 bar pressure required
360° swivel spout
Mounting hole size \varnothing 35mm
WRAS Approved

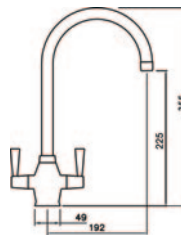
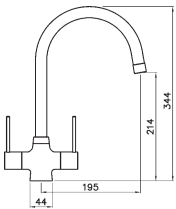
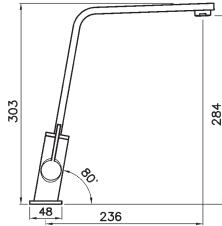

ASTRAL

Smooth sculptured lines at a very smooth price.

Astral twin lever monobloc with swivel spout

Ref. AT1156 Chrome **£211**

Ref. AT1157 Brushed Nickel **£228**

LP Min 0.3 bar pressure required
360° swivel spout
Mounting hole size \varnothing 35mm

NEXA

A modern twin lever mixer at a price to suit all budgets.

Nexa twin lever monobloc with swivel spout

Ref. AT1222 Chrome **£151**

Ref. AT1223 Brushed Nickel **£163**

LP Min 0.4 bar pressure required
360° swivel spout
Mounting hole size \varnothing 35mm

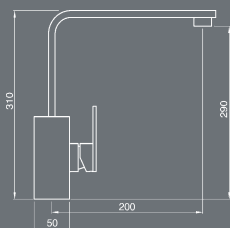

NEW MEDIA

New Media single lever monobloc with swivel spout

- Ref. AT1180** Chrome **£327**
- Ref. AT1181** Brushed Nickel **£351**
- Ref. AT1182** Granite Black **£376**

MP Min 0.5 bar pressure required
 360° swivel spout
 Mounting hole size Ø 35mm
 WRAS Applied

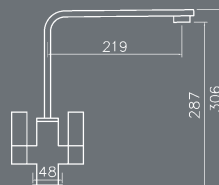

QUANTIC

Quantic twin lever monobloc with swivel spout

- Ref. AT2070** Chrome **£248**
- Ref. AT2182** Brushed Brass **£389**
- Ref. AT2105** Matt Black **£360**

MP Min 0.5 bar pressure required
 360° swivel spout
 Mounting hole size Ø 35mm
 WRAS Approved

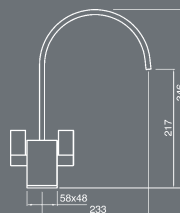

ATIK

The Atik benefits from new valve technology that are now concealed within the main body of the tap, allowing for a whole new type of design.

Atik twin lever monobloc with swivel spout

- Ref. AT1148** Chrome **£405**
- Ref. AT1149** Brushed Nickel **£409**
- Ref. AT1193** Matt Black **£432**
- Ref. AT1194** Gloss White **£305**

LP Min 0.4 bar pressure required
 360° swivel spout
 Mounting hole size Ø 35mm

abode



Chrome

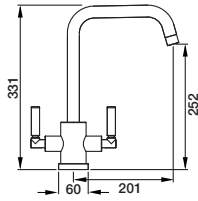

Atlas Quad twin lever monobloc with a 'U' swivel dual flow spout

Ref. AT2166
Chrome **£285**

Ref. AT2167
Brushed Nickel **£309**

Ref. AT2168
Brushed Brass **£372**

Ref. AT2169
Matt Black **£372**

ⓘ Min 0.2 bar pressure required
360° swivel spout
Mounting hole size \varnothing 35mm
WRAS Approved



Brushed Nickel



Brushed Brass



Matt Black



Brushed Nickel

ATLAS

The **Atlas** is Abode's original classic and has been so popular that a new 'U' spout model has joined the stable. The Atlas range now comes in 4 finishes, Chrome, Brushed Nickel, Brushed Brass and Matt Black giving you even more choice for your kitchen make-over.



Matt Black



Atlas twin lever monobloc with a 'C' swivel dual flow spout

Ref. AT1053 Chrome **£273**

Ref. AT1054 Brushed Nickel **£297**

Ref. AT2096 Brushed Brass **£360**

Ref. AT2097 Matt Black **£360**

ⓘ Min 0.2 bar pressure required
360° swivel spout
Mounting hole size \varnothing 35mm
WRAS Approved

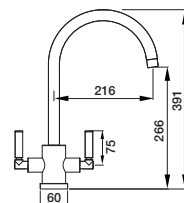



FLUID

Fluid twin lever monobloc mixer with swivel spout

Ref. AT1169 Chrome **£300**

Ref. AT1170

Brushed Nickel **£324**

MP Min 0.4 bar pressure required
360° swivel spout
Mounting hole size \varnothing 35mm

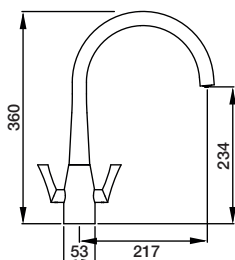

GOSFORD

The **Gosford** Monobloc takes its form from both traditional and modern styling. A tall sweeping swan neck spout and smooth tapered handles fuse with a clean symmetrical body to create a tap of modern day elegance.

Gosford twin lever monobloc with swivel dual flow spout

Ref. AT1019 Chrome **£261**

Ref. AT1020 Brushed Nickel **£288**

Ref. AT1022 Antique Bronze **£307**

MP Min 0.2 bar pressure required
360° swivel spout
Mounting hole size \varnothing 35mm

WRAS Approved

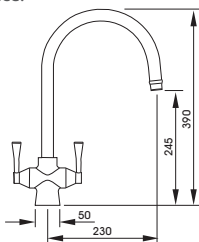

PICO

The **Pico** represents incredible value, its minimalist modern lines belie a modest price tag.

Pico twin lever monobloc mixer with swivel spout

Ref. AT1226 Chrome **£148**

Ref. AT1227 Brushed Nickel **£171**

MP Min 0.5 bar pressure required
360° swivel spout
Mounting hole size \varnothing 35mm
WRAS Approved

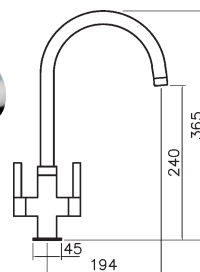

Brushed Nickel



Antique Bronze





Chrome
Matt Black
Graphite
Brushed Nickel
Urban Copper



Althia single lever monobloc with swivel spout

- Ref. AT1258** Chrome £213
- Ref. AT1259** Brushed Nickel £236
- Ref. AT1269** Graphite £297
- Ref. AT1270** Matt Black £297
- Ref. AT1272** Urban Copper £297

MP Min 0.75 bar pressure required
360° swivel spout
Mounting hole size Ø 35mm
WRAS Approved

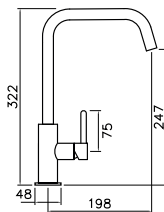

Althia single lever monobloc with swivel spout and pull-out spray

- Ref. AT1260** Chrome £316
- Ref. AT1261** Brushed Nickel £350

MP Min 1.0 bar pressure required
360° swivel spout
Mounting hole size Ø 35mm

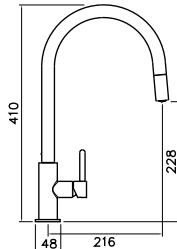

ALTHIA

The **Althia** offer slender tall minimalism with three versatile spout types; a twin lever with classic 'L' spout, an up to the minute single lever with 'U' spout and finally an elegant 'C' spout with the ever-versatile pull-out.

Althia twin lever monobloc with swivel spout

- Ref. AT1256** Chrome £213
- Ref. AT1257** Brushed Nickel £236

LP Min 0.3 bar pressure required
360° swivel spout
Mounting hole size Ø 35mm

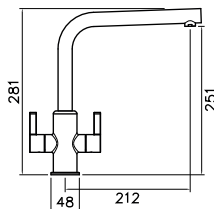

CZAR

The **Czar** have classic continental styling with a horizontal body block with single lever.

Two models; one standard swivel and one with a clever pull-out aerator which is seamlessly integrated into the spout.



Czar single lever monobloc with swivel spout and pull-out spray

Ref. AT1240 Chrome **£171**

MP Min 0.9 bar pressure required
360° swivel spout
Mounting hole size Ø 35mm

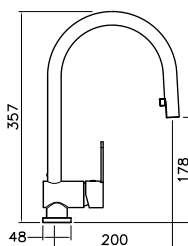

Czar single lever monobloc with swan neck swivel spout

Ref. AT1241 Chrome **£143**

MP Min 0.5 bar pressure required
360° swivel spout
Mounting hole size Ø 35mm

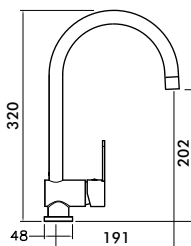

Water Pressure Explained - page 219



Polished Copper

Coniq R twin lever monobloc with swivel spout

- Ref. AT2123 Chrome £215
- Ref. AT2124 Brushed Nickel £239
- Ref. AT2125 Matt Black £276
- Ref. AT2126 Polished Copper £300

MP Min 0.75 bar pressure required
360° swivel spout
Mounting hole size Ø 35mm

CONIQ

A collection of contemporary taps featuring tapered body styles.

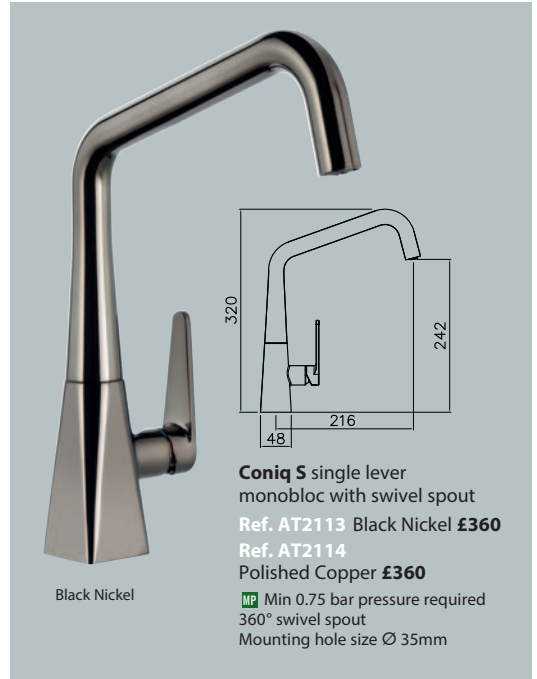

Black Nickel

Coniq S single lever monobloc with swivel spout

- Ref. AT2113 Black Nickel £360
- Ref. AT2114 Polished Copper £360

MP Min 0.75 bar pressure required
360° swivel spout
Mounting hole size Ø 35mm



Brushed Nickel

Coniq R single lever monobloc with swivel spout

- Ref. AT2115 Chrome £215
- Ref. AT2116 Brushed Nickel £239
- Ref. AT2117 Matt Black £276
- Ref. AT2118 Polished Copper £300

MP Min 0.75 bar pressure required
360° swivel spout
Mounting hole size Ø 35mm



Matt Black

Coniq R single lever monobloc with swivel spout and pull-out spray

- Ref. AT2119 Chrome £300
- Ref. AT2120 Brushed Nickel £324
- Ref. AT2121 Matt Black £360
- Ref. AT2122 Polished Copper £384

MP Min 0.75 bar pressure required
360° swivel spout
Mounting hole size Ø 35mm



Fraction Semi-Professional
single lever monobloc with
detachable spout and spray
Ref. AT2160 Chrome **£457**
Ref. AT2161 Brushed Nickel **£515**

MP Min 1.0 bar pressure required
360° swivel spout
Mounting hole size Ø 35mm

Brushed Nickel



Chrome

FRACTION

Elongated, slim single lever handle for ultimate ease of use. Industrial cog style handle with discreet hot and cold indicators.



Antique Brass

Fraction single lever monobloc with swivel spout and pull-out spray

Ref. AT2156 Chrome **£315**
Ref. AT2157 Brushed Nickel **£394**
Ref. AT2159 Matt Black **£423**
Ref. AT2158 Antique Brass **£412**

MP Min 1.5 bar pressure required
360° swivel spout
Mounting hole size Ø 35mm

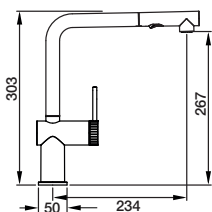

Fraction single lever monobloc with swivel spout

Ref. AT2152 Chrome **£248**
Ref. AT2153 Brushed Nickel **£315**
Ref. AT2155 Matt Black **£326**
Ref. AT2154 Antique Brass **£316**

MP Min 0.5 bar pressure required
360° swivel spout
Mounting hole size Ø 35mm

Matt Black



The industrial design of the **Hex** allow these unique taps to suit both modern and traditional settings.

HEX SINGLE LEVER



BRUSHED NICKEL

ANTIQUE BRASS

MATT BLACK

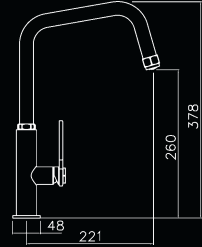
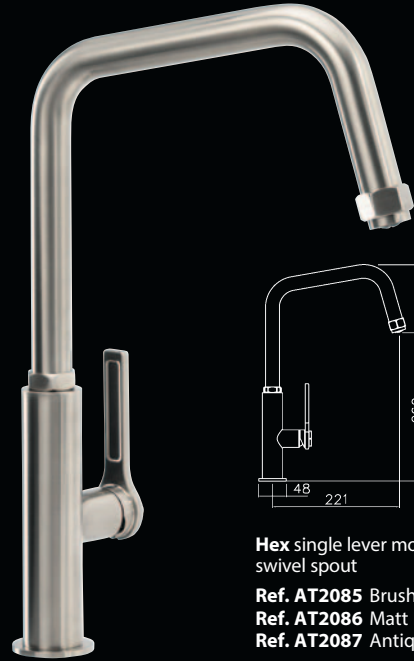

Hex single lever monobloc with swivel spout

Ref. **AT2085** Brushed Nickel **£408**

Ref. **AT2086** Matt Black **£408**

Ref. **AT2087** Antique Brass **£408**

MP Min 0.85 bar pressure required
360° swivel spout
Mounting hole size \varnothing 35mm

HEX BRIDGE PULL-OUT



Hex twin lever bridge with swivel spout and pull-out aerator

Ref. **AT2198** Brushed Nickel **£839**

Ref. **AT2199** Antique Brass **£923**

MP Min 1.25 bar pressure required
360° swivel spout
Mounting hole size \varnothing 35mm

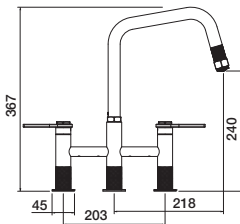

HEX TWIN LEVER

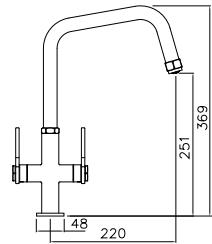
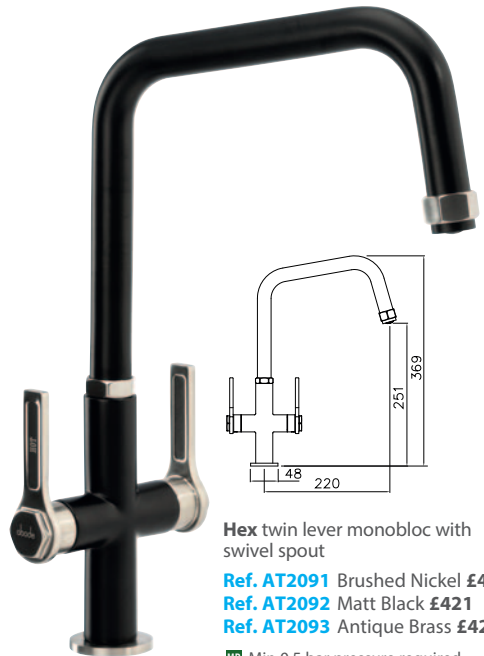

Hex twin lever monobloc with swivel spout

Ref. **AT2091** Brushed Nickel **£421**

Ref. **AT2092** Matt Black **£421**

Ref. **AT2093** Antique Brass **£421**

MP Min 0.5 bar pressure required
360° swivel spout
Mounting hole size \varnothing 35mm

HEX PULL-OUT

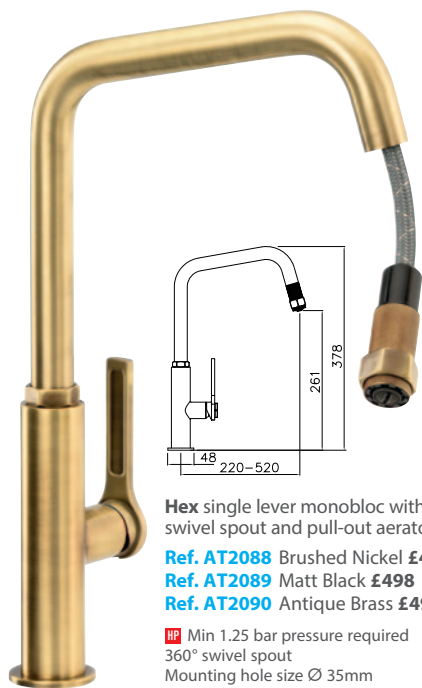

Hex single lever monobloc with swivel spout and pull-out aerator
Ref. AT2088 Brushed Nickel £498
Ref. AT2089 Matt Black £498
Ref. AT2090 Antique Brass £498

HP Min 1.25 bar pressure required
 360° swivel spout
 Mounting hole size Ø 35mm

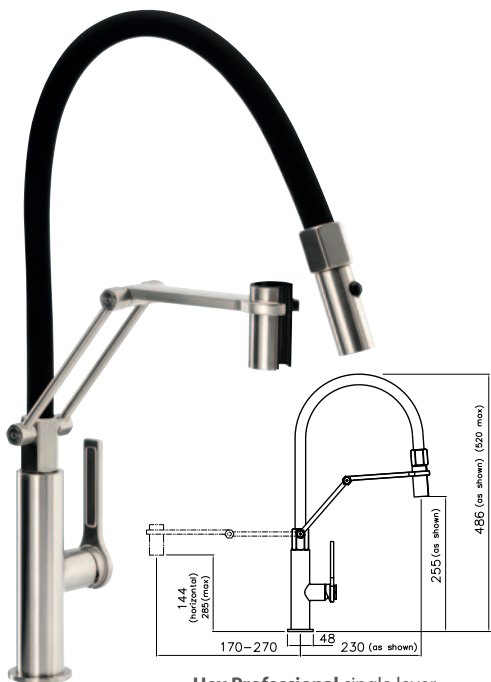

Hex Professional single lever monobloc with detachable spout and spray
Ref. AT2094 Brushed Nickel £685

HP Min 1.5 bar pressure required
 360° swivel spout
 Mounting hole size Ø 35mm



HEX PROFESSIONAL

STAINLESS STEEL

A NATURAL CHOICE... The Abode range of stainless steel taps are a perfect complement to stainless steel sinks and appliances. Hygienic and supremely hardwearing - they will retain their natural lustre for years.

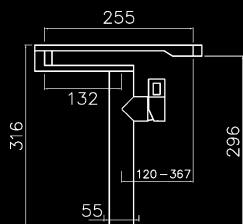

Axial Pot Filler
side lever monobloc with double swivel spout

Ref. AT2078
Stainless Steel **£348**

MP Min 0.6 bar pressure required
360° swivel spout
Mounting hole size \varnothing 35mm

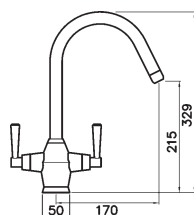

TAURA

The tapering lines add an extra element to this slick tap.

Taura twin lever monobloc mixer with swivel spout

Ref. AT1137 Stainless Steel **£415**

LP Min 0.3 bar pressure required
360° swivel spout
Mounting hole size \varnothing 35mm

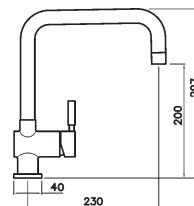

PROPUS

A modern mixer with a long reaching spout.

Propus single lever monobloc mixer with swivel spout

Ref. AT1070 Stainless Steel **£351**

MP Min 0.5 bar pressure required
360° swivel spout
Mounting hole size \varnothing 35mm
WRAS Approved



AIRO

Beautiful organic curves created from solid stainless steel this is an elegant and durable tap.

Airo twin lever monobloc mixer with swivel spout

Ref. AT2075
Stainless Steel **£342**

LP Min 0.4 bar pressure required
360° swivel spout
Mounting hole size Ø 35mm

WRAS Approved

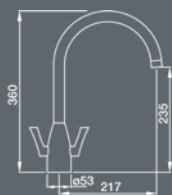

QUALA

A continental styled mixer with a particularly tall 'L' spout.

Quala single lever monobloc mixer with swivel spout

Ref. AT1198
Stainless Steel **£336**

LP Min 0.4 bar pressure required
360° swivel spout
Mounting hole size Ø 35mm

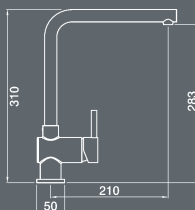

STALTO

Standing tall at 670mm, the Stalto is a truly showstopping piece in any kitchen. Coiled construction with a balanced spray head and integrated spray button.

Stalto professional single lever monobloc mixer with spring spout

Ref. AT1199 Stainless Steel **£652**

HP Min 1.0 bar pressure required
360° swivel spout
Mounting hole size Ø 35mm

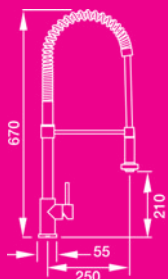



Essence supersteel with Sheer Marble hose

Enhance your kitchen's performance with the sleek, architectural **Essence Professional** tap, designed to bring professional features and convenience to your scheme. From the 360 degree turnable spring arm to the effortless EasyDock M magnetic system for the dual-spray metal head, every detail has been designed with ease of use in mind. Featuring GrohFlex technology, the hygienic santoprene hose is not only easy-to-clean but also comes in a choice of 10 colour finishes to harmonise with any kitchen.



FLOW TYPES

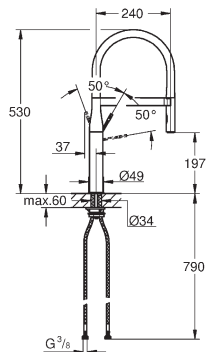

Essence Professional single lever monobloc with swivel spout and detachable spray

Ref. 30 294 000
Chrome £680

Ref. 30 294 DC0
Super Steel £883

HP Min 1.0 bar pressure required
360° swivel spout
Adjustable flow rate limiter
Mounting hole size Ø 35mm

ESSENCE Professional



EASYDOCK M
Integrated magnet for seamless docking of the spray head.

The Essence Professional comes with a black hose as standard, you have a choice of any of the 10 colours listed below with their prices as extra.

-  **30321MW0** Sheer Marble Hose **£94**
-  **30321XC0** Dark Grey Hose **£94**
-  **30321HG0** Dark Brown Hose **£94**
-  **30321YF0** Yellow Hose **£94**
-  **30321DG0** Red Hose **£94**
-  **30321YR0** Orange Hose **£94**
-  **30321GE0** Green Hose **£94**
-  **30321TY0** Blue Hose **£94**
-  **30321DU0** Purple Hose **£94**
-  **30321DP0** Pink Hose **£94**



ESSENCE

A distinctive, delicate body conceals advanced technology in the new **Essence** tap. The cylindrical body is super-slim, thanks to a new small cartridge, offering pure elegance without compromise. Choose between two models, one with swivel spout and one with a solid metal pull-out spray, which offers easy switching between mousseur and spray.

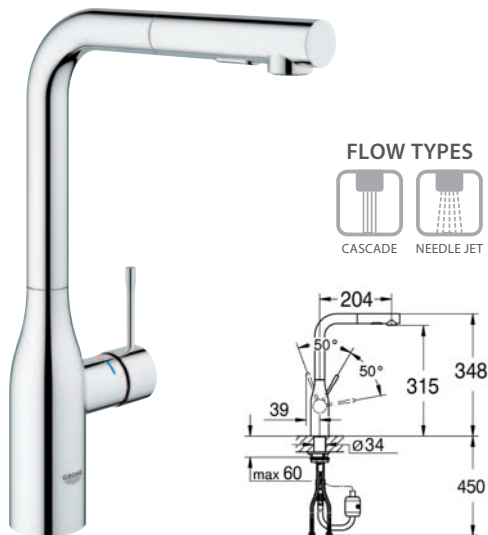

Essence single lever twin flow monobloc with swivel spout and pull-out spray/mousseur

Ref. 30 270 000 Chrome **£481**

Ref. 30 270 DC0 Super Steel **£626**

Hard Graphite - Polished **A00 £674** Brushed **AL0 £722**

Cool Sunrise - Polished **GL0 £674** Brushed **GNO £722**

Warm Sunset - Polished **DA0 £674** Brushed **DLO £722**

Nickel - Polished **BE0 £674** Brushed **ENO £722**

Add finish suffix when ordering

- HP** Min 1.0 bar pressure required
- 360° swivel spout
- Adjustable flow rate limiter
- Diverter with Mousseur/Shower Jet
- Mounting hole size Ø 35mm



Essence single lever twin flow monobloc with swivel spout

Ref. 30 269 000 Chrome **£366**

Ref. 30 269 DC0 Super Steel **£476**

Hard Graphite - Polished **A00 £512** Brushed **AL0 £549**

Cool Sunrise - Polished **GL0 £512** Brushed **GNO £549**

Warm Sunset - Polished **DA0 £512** Brushed **DLO £549**

Nickel - Polished **BE0 £512** Brushed **ENO £549**

Add finish suffix when ordering

- HP** Min 1.0 bar pressure required
- Adjustable flow rate limiter
- Selectable swivel spout 0°/150°/360°
- Mounting hole size Ø 35mm



PVD FINISHES

These taps are PVD coated ensuring the surface composition is three-times harder making the surface more resistant to damage.

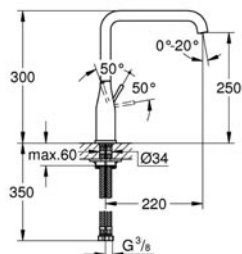
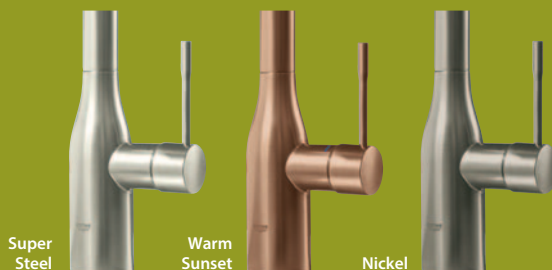

Water Pressure Explained - page 219

EUROSMART Cosmopolitan

Simplicity is at the heart of good design and functionality. That's why GROHE's

Eurosmart Cosmopolitan range focuses on the essentials to create a collection with durable details and architectural edge.

Put ergonomics and architectural lines centre-stage in your kitchen with Eurosmart Cosmopolitan. With this range simplicity doesn't mean lack of choice – from the three height options to the user-friendly swivel spout or an extractable mousseur spray you'll find a solution to suit you and your own contemporary kitchen.

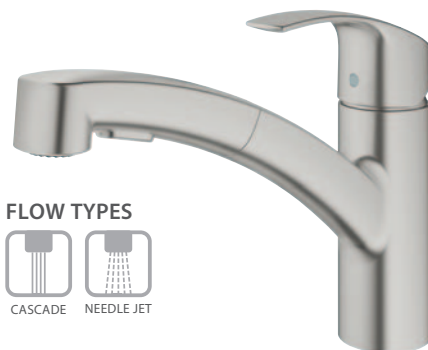

FLOW TYPES

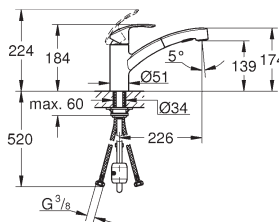

Eurosmart
top lever monobloc with swivel
spout and pull-out dual spray
Ref. 30 305 001 Chrome **£216**
Ref. 30 305 DC1 Super Steel **£281**

HP Min 1.0 bar pressure required
Adjustable flow rate limiter
Selectable swivel spout 0°/150°/360°
Mounting hole size Ø 35mm

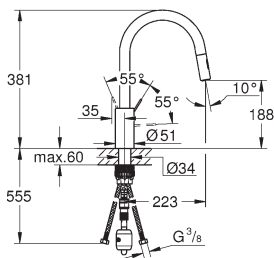

Eurosmart Cosmopolitan
single lever monobloc with swivel
spout and pull-out spray/mousseur
Ref. 31 481 001 Chrome **£293**

HP Min 1.0 bar pressure required
360° swivel spout
Adjustable flow rate limiter
Diverter with Mousseur/Shower Jet
Mounting hole size Ø 35mm

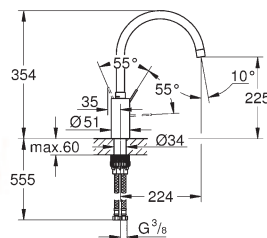

Eurosmart Cosmopolitan
single lever monobloc with
swivel spout
Ref. 32 843 002 Chrome **£216**

HP Min 1.0 bar pressure required
360° swivel spout
Adjustable flow rate limiter
Mounting hole size Ø 35mm

AMBI

The slimline minimalist **Ambi** comes in two eye-catching styles. The cool sleek **Cosmopolitan** and the modern pragmatic **Contemporary**.



Ambi Cosmopolitan
twin lever monobloc with
swivel spout

Ref. 30 190 000 Chrome **£251**

LP Min 0.4 bar pressure required
Selectable swivel spout 0°/150°/360°
Mounting hole size Ø 35mm



Ambi Contemporary
twin lever monobloc with
swivel spout

Ref. 30 189 000 Chrome
Promo Price **£275**

LP Min 0.4 bar pressure required
Selectable swivel spout 0°/150°/360°
Mounting hole size Ø 35mm



EUROCUBE

The **Eurocube** features a crisp, linear silhouette that will suit the most cosmopolitan of kitchens. This square design is further enhanced by the eye-catching cut-out detail on the lever adding to it's architectural appeal.

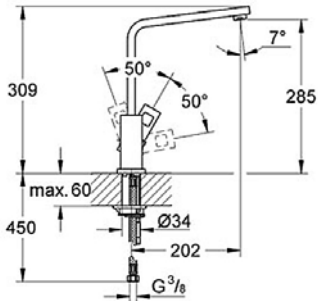

Eurocube single lever monobloc with swivel spout

Ref. 31 255 000 Chrome - Promo Price **£352**

HP Min 1.0 bar pressure required
140° swivel spout
Mounting hole size Ø 35mm
WRAS Approved



FLOW TYPES



CASCADE



NEEDLE JET

ZEDRA

The **Zedra** makes a bold statement with its stylish tapered body. The spray head has the same tapering form as the tap base.

The pull-out head has two flow-modes; cascade for normal use and needle-spray for rinsing.

Zedra single lever monobloc with extractable trigger spray / mousseur

Ref. 32 294 002 Chrome **£564**

Ref. 32 294 DC2 Super Steel **£733**

HP Min 1.0 bar pressure required
Adjustable flow rate limiter
180° swivel spout
Diverter with Mousseur/Shower Jet
Mounting hole size Ø 35mm

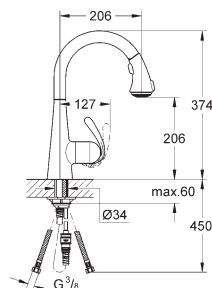

Speed Clean
Remove lime scale with a single wipe



MINTA

The **Minta** family have an understated slender elegance that has ensured them to be one of Grohe's most popular taps both here and across Europe.

There are three taps available; two pull-out versions, one with an aerated flow, one with a needle spray flow and a standard spout model.



Minta single lever monobloc with swivel spout

Ref. 32 488 000 Starlight Chrome Promo Price **£235**

Ref. 32 488 DC0 Super Steel **£305**

HP Min 1.0 bar pressure required
Adjustable flow rate limiter
360° swivel spout
Mounting hole size \varnothing 35mm
WRAS Approved



The pull-out section maintains the same slender diameter as the spout thus keeping the purity of shape.



Minta single lever monobloc with pull-out spout

Ref. 32 168 000 Starlight Chrome **£283**

Ref. 32 168 DC0 Super Steel **£368**

HP Min 1.0 bar pressure required
Adjustable flow rate limiter
150° swivel spout
Mounting hole size \varnothing 35mm

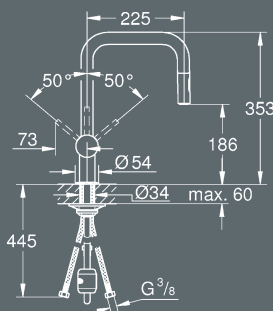

Minta single lever monobloc with extractable trigger spray / mousseur

Ref. 32 322 002 Starlight Chrome **£293**

Ref. 32 322 DC2 Super Steel **£381**

HP Min 1.0 bar pressure required
Adjustable flow rate limiter
180° swivel spout
Diverter with Mousseur / Shower Jet
Mounting hole size \varnothing 35mm

GROHE K7



Professional looks and professional level features; the K7 kitchen taps have it all. A fusion of crisp, architectural styling and practical attributes, K7 will appeal to culinary experts who settle for nothing less than the best. There are two beautifully designed models to choose from all offering very different styles and functions. The flagship model is the 'Professional' which features an arched coil that guides the extractable hose, this combines a cascade with a wide spray, while the control lever featuring GROHE SilkMove technology gives precise control of the water flow and temperature. The Professional mixer spray can be pulled out, turned and swivelled 360° and operated with one hand. Furthermore, you can switch back and forth between the spray and cascade without having to turn off the water. A choice of two surfaces finishes gives the mixers two distinctive looks. GROHE StartLight chrome lends an air of elegant modernity to the design, while SuperSteel embodies the strength and pure luxury of the range.

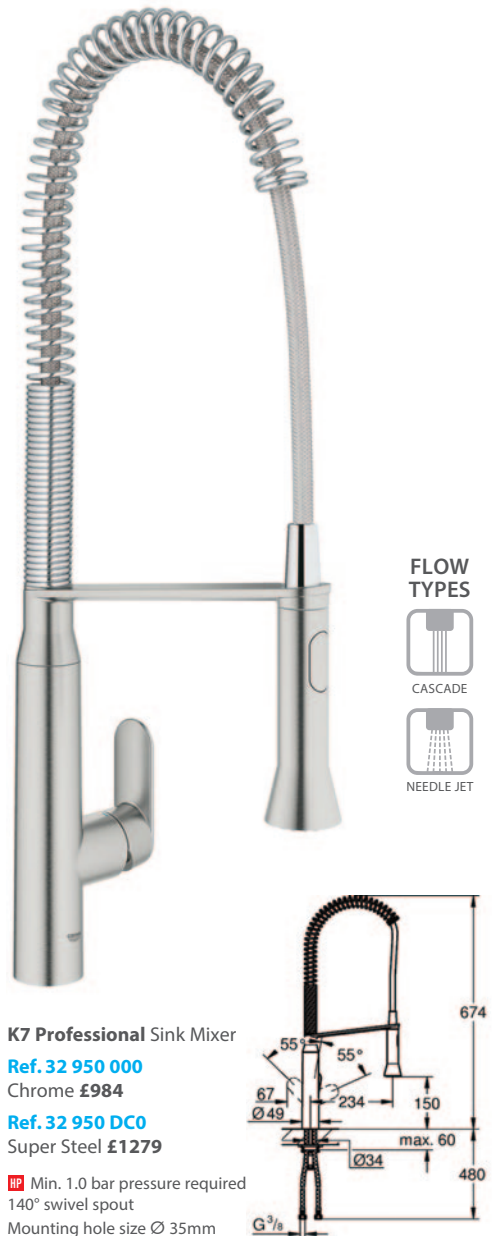

K7 Professional Sink Mixer

Ref. 32 950 000

Chrome **£984**

Ref. 32 950 DC0

Super Steel **£1279**

HP Min. 1.0 bar pressure required
140° swivel spout
Mounting hole size Ø 35mm

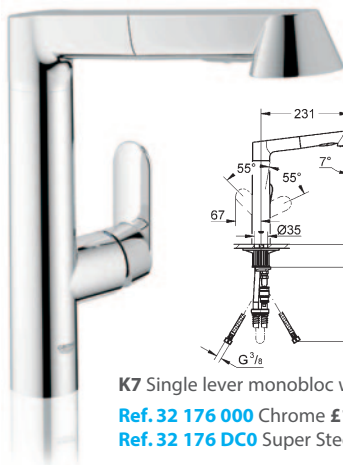

FLOW TYPES



CASCADE



NEEDLE JET

K7 Single lever monobloc with pull-out spray

Ref. 32 176 000 Chrome **£1010**

Ref. 32 176 DCO Super Steel **£1313**

HP Min. 1.0 bar pressure required
140° swivel spout

Mounting hole size \varnothing 35mm

Pull-out hose length 800mm



Water Pressure
Explained - page 219



DENBY

TRADITIONAL TAPS

A nostalgic collection of high quality period reproduction taps await you over the next few pages. If you are looking for a Victorian, Edwardian or a Baroque theme then we will definitely have the right tap for you.

Our traditional collection has been collated from only respected British and European manufacturers where authenticity and quality has always been the overriding goal.

All these taps combine their historical aesthetics with the same modern technology used with their contemporary cousins, ensuring smooth and efficient operation.



About Water Pressure

Gravity - it is very important that before you purchase your tap you establish the water pressure in your home. If you have a traditional hot water cylinder the pressure will be determined by gravity only. Measure the height from the bottom of your cold water storage tank (usually located in the loft) to your kitchen tap - the longer the drop the more pressure you will have - see table below.

If you have a combination boiler these usually provide a good level of pressure; usually between 1.5 - 2 bar with an average mains pressure coming in to your house.

0.1 Bar = 3 foot head of pressure

0.2 Bar = 6 foot of pressure

0.5 Bar = 15 foot of pressure

1.0 Bar = 30 foot head of pressure

LP 0.1 - 0.49

MP 0.5 - 0.99

HP 1.0 Plus

Look out for our minimum bar guides shown with each tap, use in conjunction with this table to assist in selecting the correct tap for your home.





TRADITIONAL

These traditional models are a nostalgic collection of high quality reproduction period taps. All these taps combine their historical aesthetics with the modern technology used with their Modern cousins. Each tap is available in a choice of finishes as illustrated on these pages.



Matching Wastes available see page 158

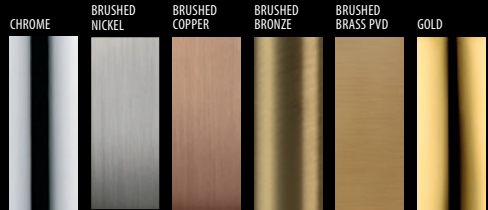

Elegance Bridge with Traditional Pull-Out Spray in Brushed Brass - see page 263



ELEGANCE

The **Elegance** taps truly reflect our elegant past with ceramic control levers and tall swan neck spouts.

The monobloc style is a popular choice with ceramic inset sinks whilst the Bridge model works perfectly with Apron front Belfast models.

The spout incorporates a Twist & Spray Aerator to suit multiple kitchen chores.



TWIST & SPRAY®

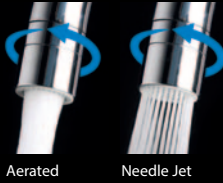

Aerated Needle Jet

These taps are fitted with the unique **Twist & Spray** aerator which provides two flow types that can be changed with a simple twist of the flange.

The Twist & Spray has greatly widened the standard tap's range of abilities in one simple twist.

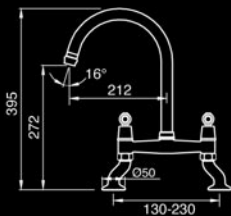

ELEGANCE BRIDGE

Ref. **ELB10CP** Chrome **£239**

Ref. **ELB10BN** Brushed Nickel PVD **£249**

Ref. **ELB10BZ** Brushed Bronze PVD **£289**

Ref. **ELB10BC** Brushed Copper PVD **£269**

Ref. **ELB10BB** Brushed Brass PVD **£279**

WRAS Approved

Quarter turn ceramic disc valves

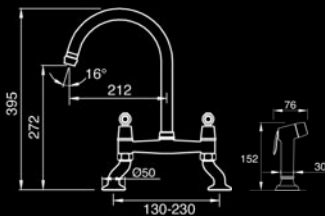

ELEGANCE BRIDGE & PULL-OUT SPRAY

Ref. **ELBR10CP** Chrome **£348**

Ref. **ELBR10BN** Brushed Nickel PVD **£373**

Ref. **ELBR10BZ** Brushed Bronze PVD **£427**

Ref. **ELBR10BC** Brushed Copper PVD **£397**

Ref. **ELBR10BB** Brushed Brass PVD **£412**

WRAS Approved

Quarter turn ceramic disc valves



Elegance with Traditional Pull-Out Spray in Brushed Nickel - see page 263

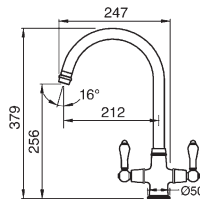

ELEGANCE

Ref. **EL20CP** Chrome **£219**

Ref. **EL20BN** Brushed Nickel PVD **£229**

Ref. **EL20BZ** Brushed Bronze PVD **£259**

Ref. **EL20BC** Brushed Copper PVD **£239**

Ref. **EL20BB** Brushed Brass PVD **£249**

WRAS Approved

Quarter turn ceramic disc valves

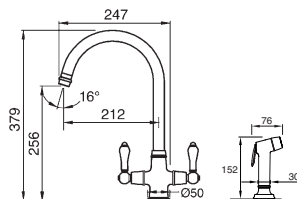

ELEGANCE & PULL-OUT SPRAY

Ref. **ELR20CP** Chrome **£328**

Ref. **ELR20BN** Brushed Nickel PVD **353**

Ref. **ELR20BZ** Brushed Bronze PVD **£397**

Ref. **ELR20BC** Brushed Copper PVD **£367**

Ref. **ELR20BB** Brushed Brass PVD **£382**

WRAS Approved

Quarter turn ceramic disc valves



TAP ICONS EXPLAINED



Twist & Spray
A simple twist of the spout flange will change the water from aerated to needle jet flow.



Minimum Operating Water Pressure
See full water pressure guide on page 305.



Maximum Spout Swivel



Matching Wastes available
see page 158.

TRADITIONAL

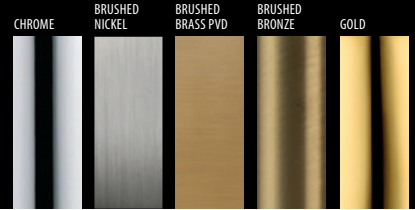

Brushed Nickel

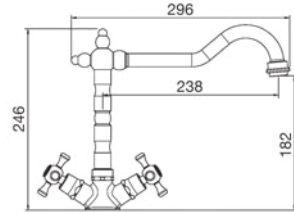

BAROC

- Ref. BAC Chrome £250
- Ref. BAN Brushed Nickel £285
- Ref. BAB Brushed Bronze £285
- Ref. BABR Brushed Brass £318

Full turn compression valves



BAROC

The Baroc's exuberant styling echo the distinctive styles of the Baroque period and are perfect partner with traditional style ceramic sinks. As with most of our traditional collection there are many metal finishes to choose from and don't forget wastes can be colour matched with the taps.



BAROC BRIDGE

- Ref. BBC Chrome £320
- Ref. BBN Brushed Nickel £354
- Ref. BBB Brushed Bronze £354
- Ref. BBBR Brushed Brass £402

Full turn compression valves



Brushed Bronze

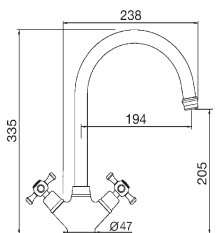

COTTAGE

- Ref. COTC** Chrome £242
- Ref. COTN** Brushed Nickel £311
- Ref. COTG** Gold £311
- Ref. COTB** Brushed Bronze £311
- Ref. COTBR** Brushed Brass £311

Full turn compression valves
WRAS Approved



Chrome



COTTAGE

The **Cottage** taps are a nostalgic family of taps with crosshead controls with ceramic indices. As with all of our traditional taps they are ideally matched with traditional ceramic sinks to complete the country farmhouse or retro theme.

TAP ICONS EXPLAINED



Minimum Operating Water Pressure
See full water pressure guide on page 305.



Maximum Spout Swivel



Dual Flow
Keeps the flow of hot and cold water separate in the tap Spout.

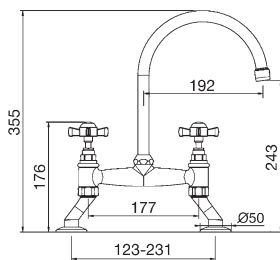

COTTAGE BRIDGE

- Ref. COTBC** Chrome £361
 - Ref. COTBN** Brushed Nickel £450
 - Ref. COTBG** Gold £450
 - Ref. COTBB** Brushed Bronze £450
 - Ref. COTBBR** Brushed Brass £450
- Full turn compression valves



Matching Wastes available
see page 158



Brushed Nickel



Matching Wastes available see page 158



TRADITIONAL

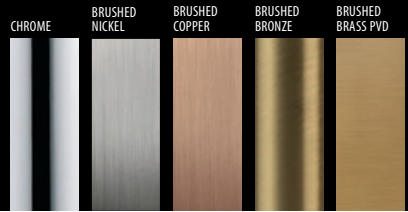

Chrome

Chrome

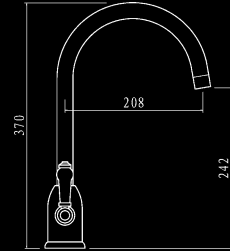

DEPHINI

Ref. DE2CP Chrome £209

Ref. DE2BN Brushed Nickel PVD £229



DEPHINI

The **Dephini** twin lever monobloc is based on a traditional design but with a modern twist, whilst the **Bridge** strictly follows a nostalgic format with scrolling on the valve covers and the spout. Note with the **Bridge** mixer the levers face forward when in the off position.

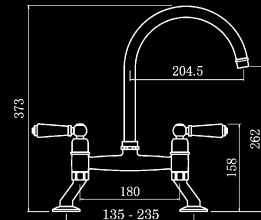

DEPHINI BRIDGE

Ref. DE3CP Chrome £244

Ref. DE3BN Brushed Nickel PVD £263



TAP ICONS EXPLAINED



Cold Start
Energy saving cartridge means when the lever is in the vertical position, it only dispenses cold water and not mixed. Forward rotation avoids the lever hitting the splashback.



Minimum Operating Water Pressure
See full water pressure guide on page 305.



Maximum Spout Swivel



Dual Flow
Keeps the flow of hot and cold water separate in the tap Spout.

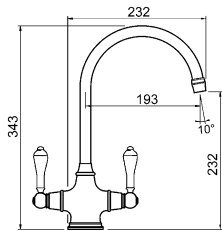

ALRISHA

The **Alrish**'s flamboyant scroll detailing add a luxurious extravagance to this elegant neo-Victorian design.

- Ref. ALR2CP** Chrome £350
- Ref. ALR2BN** Brushed Nickel £375
- Ref. ALR2BZ** Brushed Bronze £415
- Ref. ALR2BC** Brushed Copper £423
- Ref. ALR2BB** Brushed Brass £423

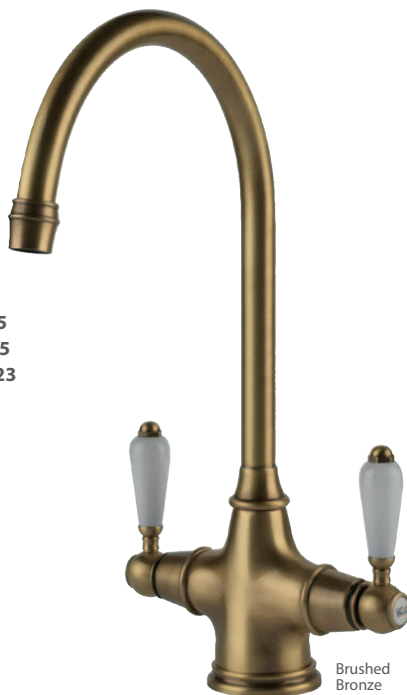

Brushed Bronze



CORIOLIS

The **Coriolis** shares the same fine scroll detail as the Alrish but differs with its rather intriguing forward facing ceramic indices denoting the water temperature.

- Ref. CO2CP** Chrome £331
- Ref. CO2BN** Brushed Nickel £358
- Ref. CO2BZ** Brushed Bronze £364
- Ref. CO2BC** Brushed Copper £385
- Ref. CO2BB** Brushed Brass £385

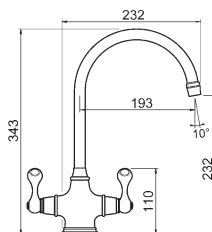

Brushed Copper

REGENT

The **Regent** straddles contemporary and traditional styling with its soft curves and ceramic detailing.

- Ref. LANCP** Chrome £236
- Ref. LANBN** Brushed Nickel £299
- Ref. LANBZ** Brushed Bronze £280
- Ref. LANBB** Brushed Brass £324

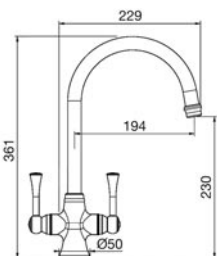

Brushed Nickel



Established in 1978, Perrin & Rowe has become the largest independent manufacturer of taps in the UK. With factories in Tamworth, Rainham and Wolverhampton, all Perrin & Rowe products are manufactured here in the UK by a skilled team of engineers. Renowned for its commitment to quality, design and innovation, Perrin & Rowe is a true British success story. Having built an enviable reputation and a premium portfolio of hand-crafted products, Perrin & Rowe is globally recognised as a market leader and highly respected British manufacturer.



The Rinse

Hot, cold or mixed water is diverted to the rinse once the top button is pressed. Perrin & Rowe hand rinses have been designed to cope with even low water pressures; the integration of a patented diverter means that they can be effective with just 1 bar of pressure.

Special Finishes

A range of luxurious, warm metallic hues custom made to order.

Prices

English Bronze (BZ) - add 25% to Chrome price

Satin Brass (SB), Gold (IG), Polished Brass (BR) and Aged Brass (AB) - add 35% to Chrome price

Allow up to 10 to 12 weeks for delivery. *(Use suffix when ordering)*



English Bronze (BZ)



Satin Brass (SB)

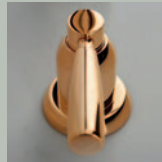

Gold (IG)

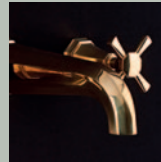

Polished Brass (BR)

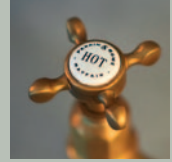

Aged Brass (AB)

PHOENICIAN

The Phoenician is a nostalgic reminder of our Edwardian past. The extra details such as the base scrolls really add to the luxuriousness of this tap.

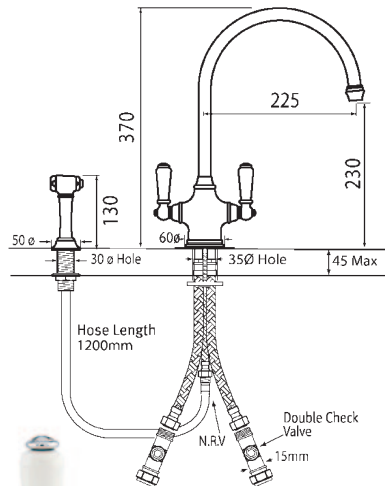

Phoenician monobloc with twin porcelain lever handles

Ref. 4460 CP Chrome **£467**

Ref. 4460 NI Nickel **£513**

Ref. 4460 PF Pewter **£561**

Ref. 4460 IG Gold **£630**

Phoenician monobloc with twin porcelain lever handle and rinse

Ref. 4360 CP Chrome **£671**

Ref. 4360 NI Nickel **£738**

Ref. 4360 PF Pewter **£805**

Ref. 4360 IG Gold **£905**

Recommended working pressure

RP Min 1.0 bar Max 5.0 bar

Quarter turn ceramic disc flow control

Bi-flow spout

360° swivel spout

Mounting hole sizes \varnothing 35mm

Rinse pull-out hose length 60cm

Rinse mounting hole size \varnothing 30mm



Scroll detail

IONIAN

The **Ionian** continues the Edwardian theme with bridge mounted crank legs that raise the tap high above the sink. The modern quarter turn CD valves are covered by faceted shrouds adding welcome detailing to these elegant taps.

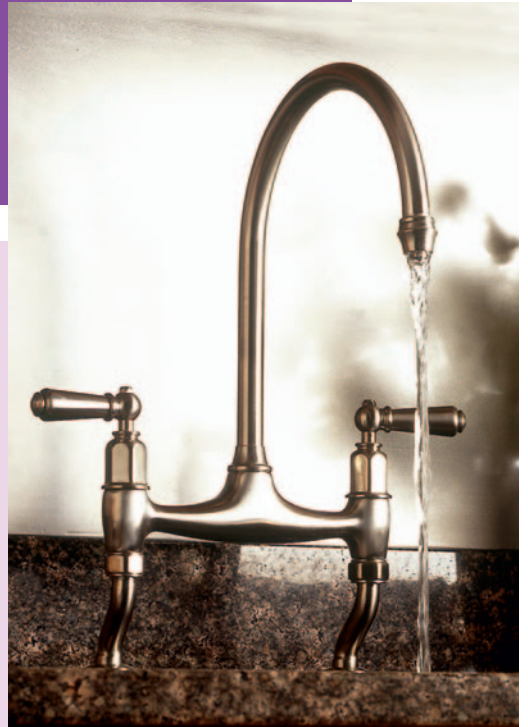

IONIAN Lever Handles

Ionian two-hole sink mixer with porcelain lever handles

Ref. 4193 CP Chrome £579

Ref. 4193 NI Nickel £637

Ref. 4193 PF Pewter £696

Ref. 4193 IG Gold £782



Ionian two-hole sink mixer with porcelain lever handles and rinse

Ref. 4173 CP Chrome £789

Ref. 4173 NI Nickel £868

Ref. 4173 PF Pewter £947

Ref. 4173 IG Gold £1066

HP Min 1.0 bar pressure required
Quarter turn ceramic disc flow control
Bi-flow spout
360° swivel spout
Mounting hole sizes \varnothing 25mm
Rinse pull-out hose length 60cm
Rinse mounting hole size \varnothing 30mm
Tap-hole centres 140-260mm -
Straight 200mm

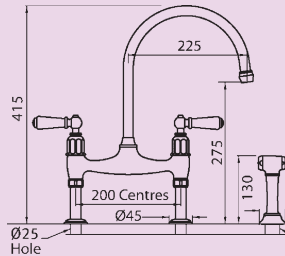

IONIAN Crosshead Handles

Ionian two-hole sink mixer with crosshead handles

Ref. 4192 CP Chrome £579

Ref. 4192 NI Nickel £637

Ref. 4192 PF Pewter £696

Ref. 4192 IG Gold £782

Recommended working pressure
HP Min 1.0 bar Max 5.0 bar
Quarter turn ceramic disc flow control
Bi-flow spout
360° swivel spout
Mounting hole sizes \varnothing 25mm
Rinse mounting hole size \varnothing 30mm
Tap-hole centres 140-260mm - Straight 200mm

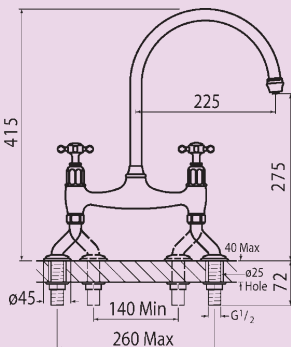

Water Pressure
Explained - page 305



Provence two-hole sink mixer with crosshead handles

- Ref. 4750 CP** Chrome **£693**
- Ref. 4750 NI** Polished Nickel **£762**
- Ref. 4750 PF** Pewter **£832**
- Ref. 4750 IG** Gold **£935**

Provence two-hole sink mixer with crosshead handles and rinse

- Ref. 4755 CP** Chrome **£904**
- Ref. 4755 NI** Polished Nickel **£994**
- Ref. 4755 PF** Pewter **£1084**
- Ref. 4755 IG** Gold **£1219**

Recommended working pressure
RP Min 1.0 bar Max 5.0 bar
 Quarter turn ceramic disc flow control
 Single flow spout
 360° swivel spout
 Mounting hole sizes Ø 25mm
 Rinse mounting hole size Ø 30mm
 Rinse pull-out hose length 60cm
 Tap-hole centres 200mm
 WRAS Approved

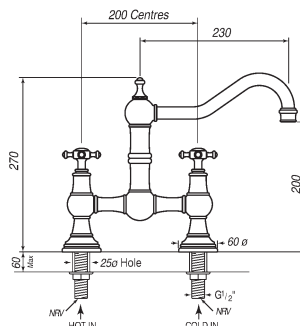

PICARDIE

The **Picardie** is the more usual single hole mixer and as such can be fitted in most situations, either on a topmount sink or on the work surface.

Picardie sink mixer with twin levers

- Ref. 4761 CP** Chrome **£552**
- Ref. 4761 NI** Polished Nickel **£607**
- Ref. 4761 PF** Pewter **£663**
- Ref. 4761 IG** Gold **£745**

Picardie sink mixer with twin levers and rinse

- Ref. 4766 CP** Chrome **£755**
- Ref. 4766 NI** Polished Nickel **£832**
- Ref. 4766 PF** Pewter **£906**
- Ref. 4766 IG** Gold **£1020**

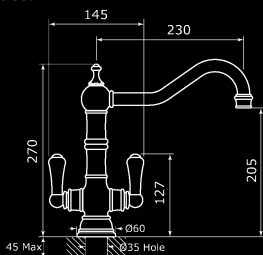

Recommended working pressure
RP Min 1.0 bar Max 5.0 bar
 Quarter turn ceramic disc flow control
 Single flow spout
 360° swivel spout
 Mounting hole size Ø 35mm
 Rinse mounting hole size Ø 30mm
 Rinse pull-out hose length 60cm
 WRAS Approved



PARTHIAN

The **Parthian** tilts at our Edwardian past but has a modern twist with an easy to operate single lever control.

Parthian monobloc mixer with single porcelain lever handle and swivel spout

Ref. 4341 CP Chrome **£468**

Ref. 4341 NI Polished Nickel **£514**

Ref. 4341 PF Pewter **£562**

Ref. 4341 IG Gold **£632**

Recommended working pressure
Min 1.0 bar Max 5.0 bar
Quarter turn ceramic disc flow control
Single flow spout
360° swivel spout
Mounting hole size Ø 35mm
WRAS Approved

MINOAN

The **Minoan** Victorian styled tap has exquisite brass detailing from the faceted shroud covers to the crosshead controls with porcelain 'Hot' and 'Cold' indices bearing the manufacturers name.

Minoan monobloc mixer with crosshead handles and swivel spout

Ref. 4385 CP Chrome **£478**

Ref. 4385 NI Polished Nickel **£527**

Ref. 4385 PF Pewter **£575**

Ref. 4385 IG Gold **£646**

Recommended working pressure
HP Min 1.0 bar Max 5.0 bar
Quarter turn ceramic disc flow control
Bi-flow spout
360° swivel spout
Mounting hole size Ø 35mm
WRAS Approved

ETRUSCAN

The most notable feature of this retro tap is it's forward facing indices denoting water temperature.



Etruscan monobloc mixer with lever handles and swivel spout

Ref. 4320 CP Chrome **£467**

Ref. 4320 NI Polished Nickel **£513**

Ref. 4320 PF Pewter **£561**

Ref. 4320 IG Gold **£631**

Recommended working pressure
HP Min 1.0 bar Max 5.0 bar
Quarter turn ceramic disc flow control
Bi-flow spout
360° swivel spout
Mounting hole size Ø 35mm
WRAS Approved



MAYAN

A nostalgic collection of Bibcock taps - for those who don't want a mixer tap and prefer the purity of individual hot and cold taps there really is no better choice than the **Mayan** to take you back in time.



Mayan Bibcocks deck mounted with crosshead handles (pair)

- Ref. 4338 CP** Chrome **£388**
- Ref. 4338 NI** Polished Nickel **£427**
- Ref. 4338 PF** Pewter **£465**
- Ref. 4338 IG** Gold **£524**

Recommended working pressure
LP Min 0.2 bar Max 5.0 bar
 Quarter turn ceramic disc flow control
 Mounting hole size \varnothing 25mm
WRAS Approved

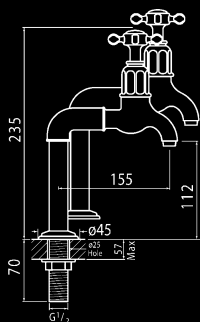

Mayan Bibcocks deck mounted with porcelain lever handles (pair)

- Ref. 4332 CP** Chrome **£388**
- Ref. 4332 NI** Polished Nickel **£427**
- Ref. 4332 PF** Pewter **£465**
- Ref. 4332 IG** Gold **£524**

Recommended working pressure
LP Min 0.2 bar Max 5.0 bar
 Quarter turn ceramic disc flow control
 Mounting hole size \varnothing 25mm
WRAS Approved

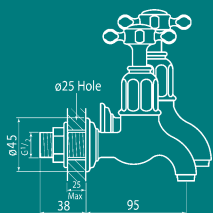
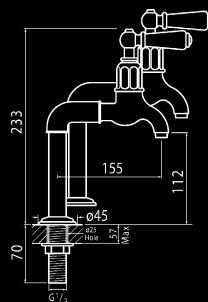

Mayan Bibcocks wall mounted with crosshead handles (pair)

- Ref. 4328 CP** Chrome **£388**
- Ref. 4328 NI** Polished Nickel **£427**
- Ref. 4328 PF** Pewter **£465**
- Ref. 4328 IG** Gold **£524**

Recommended working pressure
LP Min 0.2 bar Max 5.0 bar
 Quarter turn ceramic disc flow control
 Mounting hole size \varnothing 25mm
WRAS Approved

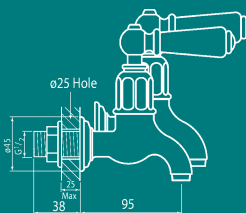

Mayan Bibcocks wall mounted with porcelain lever handles (pair)

- Ref. 4322 CP** Chrome **£388**
- Ref. 4322 NI** Polished Nickel **£427**
- Ref. 4322 PF** Pewter **£465**
- Ref. 4322 IG** Gold **£524**

Recommended working pressure
LP Min 0.2 bar Max 5.0 bar
 Quarter turn ceramic disc flow control
 Mounting hole size \varnothing 25mm
WRAS Approved





Armstrong monobloc with textured lever handle

Ref. 4512 CP Chrome **£487**

Ref. 4512 NI Nickel **£536**

Ref. 4512 PF Pewter **£584**

Special Finishes **£657**

English Bronze **£608**

Recommended working pressure

HP Min 1.0 bar Max 5.0 bar

Quarter turn ceramic disc flow control

360° swivel spout

Mounting hole sizes Ø 35mm

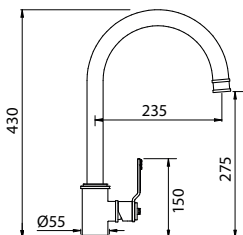

ARMSTRONG

The Industrial elements of the **Armstrong** taps are inspired by the steam locomotive designers Joseph and George Armstrong; brothers who worked for the Great Western Railway 150 years ago.

Perrin & Rowe have embraced their design ethos and engineering excellence by creating a range of taps fit to bear their name.

Armstrong lever options - add suffix when ordering.

HT for Textured

HS for Smooth



HT

HS



Armstrong monobloc with textured lever handle and pull-out spray

Ref. 4544 CP Chrome **£699**

Ref. 4544 NI Nickel **£770**

Ref. 4544 PF Pewter **£840**

Special Finishes **£945**

English Bronze **£875**

Recommended working pressure

HP Min 1.0 bar Max 5.0 bar

Quarter turn ceramic disc flow control

360° swivel spout

Pull-out hose length 50cm

Mounting hole sizes Ø 35mm

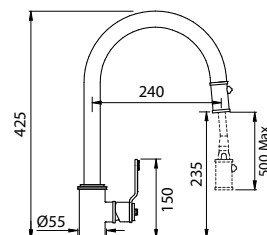



Armstrong Bridge
with textured lever
handles and pull-out spray
Ref. 4549 CP Chrome £840
Ref. 4549 NI Nickel £912
Ref. 4549 PF Pewter £995
Special Finishes £1119
English Bronze £1037

Recommended working pressure
MP Min 1.0 bar Max 5.0 bar
Quarter turn ceramic disc flow control
360° swivel spout
Pull-out hose length 50cm
Mounting hole sizes \varnothing 25mm

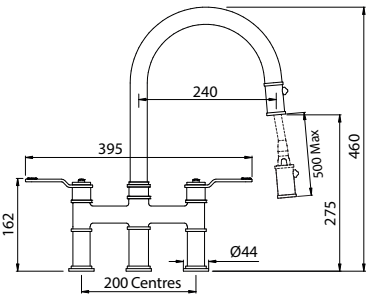

Armstrong Bridge with
textured lever handles
Ref. 4593 CP Chrome £608
Ref. 4593 NI Nickel £669
Ref. 4593 PF Pewter £730
Special Finishes £821
English Bronze £761

Recommended working pressure
MP Min. 0.5 bar Max 5.0 bar
Quarter turn ceramic disc flow control
360° swivel spout
Mounting hole sizes \varnothing 25mm

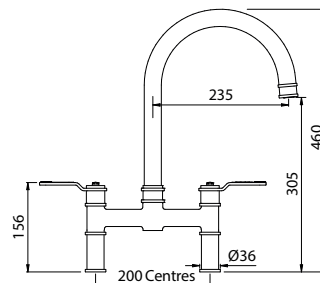

Standard Finishes



Chrome CP



Polished Nickel NI



Pewter PF

Special Finishes

Allow 10 to 12 weeks delivery



Gold IG



Aged Brass AB



English Bronze BZ



Polished Brass BR



Satin Brass SB



ESTO ())

BASIN SENSOR

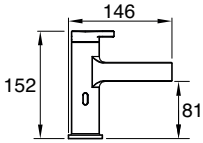

ESTO

The **Esto Sensor** basin mixer combines ultra-modern aesthetics with smart technology. The touchless control enables just a simple hand movement to commence water flow helping to maintain a germ-free hygienic environment.

Ref. ESL10CP Chrome £189



- **INTELLIGENT MOTION TECHNOLOGY**
Reliable touchless on/off operation
- **PRECISE ACTIVATION ZONE**
Utilises state-of-the-art sensor to prevent false activations
- **DUAL OPERATION**
Optional manual and Touchless control
- **BATTERY OPERATED**
No power supply necessary

PRODUCTS FOR CARE AND CLEANING

We have an amazing range of sinks and taps and always recommend that they are cleaned and cared for to keep their charm and beauty the same as the day they were installed.

CARE OF SINKS



GRANITE

**Clearwater
Granite Care Set
Ref. CLEG100 £40**

Comprising of -
an alcohol based cleaner
a brightener and a
nano sponge



CERAMIC & CAST IRON

**Clearwater
Cast Iron and
Ceramic Cleaner
Ref. CLEC200 £14**

Removes stubborn metal
marks and stains with little
effort



STAINLESS

**HG - Stainless Polish
Ref. 168030106 £6**

Designed for maintenance of
Stainless Steel, leaving a great
shine and streak free, great for
combating really tough
blemishes.

250ml



CERAMIC & STAINLESS

**Cramer - Email Star
Ref. 30100 £14**

Sensitive, acid free cleaning
and care of Ceramic, Enamel
and Stainless surfaces.

100ml

CARE OF TAPS



POLISHING

**Cramer - Chrom Star
Ref. 30150 £14**

Gentle cleaning and polishing
compound for all chrome
surfaces.

100ml

FOR DAMAGES TO ENAMEL & CERAMIC



**Cramer - Bath & Kitchen
Rubber
Ref. 30303 £17**

Removes scuff marks, rust and
heavy soiling on Enamel and
Ceramic without scratching.



**Cramer - Repair Kit
Ref. 16XXX £36**

For minor damage and chips
to Ceramic, Enamel & Acrylic.
For an easy and durable
repair.

● Postage and packaging charges may be incurred. ● Cleaning products can either be ordered from the retailer or direct from us.

sterling



Please ask for your copy of our Clearwater exclusive Sink and Tap catalogue.



Scan for
Website



Scan for
Digital Copy

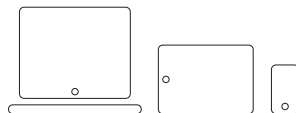

Desktop | Tablet | Mobile

www.sterling.eu.com

sterling

Shannon Place
Tewkesbury Business Park
Tewkesbury GL20 8SL

Telephone: 01684 299555

Enquiries: orders@sterling.eu.com

To order: orders@sterling.eu.com

Website: www.sterling.eu.com

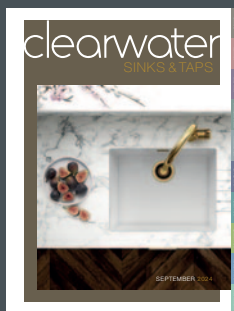

Please ask for your copy of our
Clearwater exclusive sink and
tap Catalogue.